

SONY®

VAIO® 505 SuperSlim Notebook User Guide

PCG-505TS/PCG-505TX



Notice to Users

© 1999 Sony Electronics Inc. All rights reserved. This manual and the software described herein, in whole or in part, may not be reproduced, translated, or reduced to any machine-readable form without prior written approval.

SONY ELECTRONICS INC. PROVIDES NO WARRANTY WITH REGARD TO THIS MANUAL, THE SOFTWARE, OR OTHER INFORMATION CONTAINED HEREIN AND HEREBY EXPRESSLY DISCLAIMS ANY IMPLIED WARRANTIES OF MERCHANTABILITY OR FITNESS FOR ANY PARTICULAR PURPOSE WITH REGARD TO THIS MANUAL, THE SOFTWARE, OR SUCH OTHER INFORMATION. IN NO EVENT SHALL SONY ELECTRONICS INC. BE LIABLE FOR ANY INCIDENTAL, CONSEQUENTIAL, OR SPECIAL DAMAGES, WHETHER BASED ON TORT, CONTRACT, OR OTHERWISE, ARISING OUT OF OR IN CONNECTION WITH THIS MANUAL, THE SOFTWARE, OR OTHER INFORMATION CONTAINED HEREIN OR THE USE THEREOF.

Sony Electronics Inc. reserves the right to make any modification to this manual or the information contained herein at any time without notice. The software described herein is governed by the terms of a separate user license agreement.

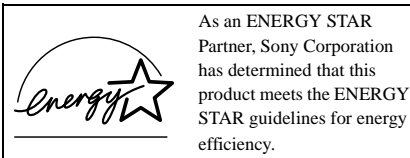

The International ENERGY STAR Office Equipment Program is an international program that promotes energy saving through the use of computers and other office equipment. The program backs the development and dissemination of products with functions that effectively

reduce energy consumption. It is an open system in which business proprietors can participate voluntarily. The targeted products are office equipment such as computers, displays, printers, facsimiles and copiers. Their standards and logos are uniform among participating nations. ENERGY STAR is a U.S. registered mark.

Sony, i.LINK, VAIO and the VAIO logo are trademarks of Sony Corporation. ImageStation and Sony VAIO Direct are service marks of Sony Electronics Inc. Windows and the Windows 98 logo are registered trademarks of Microsoft Corporation.

All other trademarks are trademarks of their respective owners.

Safety Information

Owner's Record

The model number and serial number are located on the bottom of your Sony VAIO® 505 SuperSlim Notebook. Record the serial number in the space provided here. Refer to the model and serial number when you call your Sony Service Center.

Model Number: PCG-505TS/PCG-505TX

Serial Number: _____

WARNING

- To prevent fire or shock hazard, do not expose your notebook computer to rain or moisture.
- To avoid electrical shock, do not open the cabinet. Refer servicing to qualified personnel only.
- Never install modem or telephone wiring during a lightning storm.
- Never install telephone jacks in wet locations unless the jack is specifically designed for wet locations.
- Never touch uninsulated telephone wire or terminals unless the telephone

line has been disconnected at the network interface.

- ❑ Use caution when installing or modifying telephone lines.
- ❑ Avoid using the modem during an electrical storm.
- ❑ Do not use the modem or a telephone to report a gas leak in the vicinity of the leak.
- ❑ A socket outlet should be as close as possible to the unit and easily accessible.

AVERTISSEMENT

- ❑ Pour prévenir tout risque d'incendie ou d'électrocution, garder cet appareil à l'abri de la pluie et de l'humidité.
- ❑ Pour prévenir tout risque d'électrocution, ne pas ouvrir le boîtier. Confier l'entretien de cet appareil exclusivement à un personnel qualifié.
- ❑ L'appareil doit être le plus près possible d'une prise murale pour en faciliter l'accès.

Regulatory Information

Declaration of Conformity

Trade Name: SONY

Model No: PCG-505TS/PCG-505TX

Responsible Party:
Sony Electronics Inc.

Address:
1 Sony Drive
Park Ridge, NJ 07656

Telephone No.: 201-930-6970

This device complies with Part 15 of the FCC rules. Operation is subject to the following two conditions: (1) This device may not cause harmful interference, and (2) this device must accept any interference received, including interference that may cause undesired operation.

This equipment has been tested and found to comply with the limits for a Class B digital device, pursuant to Part 15 of the FCC Rules. These limits are designed to provide reasonable protection against harmful interference in a residential installation. This equipment generates, uses, and can radiate radio frequency energy and, if not installed and used in accordance with the instructions, may cause harmful interference to radio communications.

However, there is no guarantee that interference will not occur in a particular installation. If this equipment does cause harmful interference to radio or television reception, which can be determined by turning the equipment off and on, the user is encouraged to try to correct the interference by one or more of the following measures:

- ❑ Reorient or relocate the receiving antenna.
- ❑ Increase the separation between the equipment and the receiver.
- ❑ Connect the equipment into an outlet on a circuit different from that to which the receiver is connected.
- ❑ Consult the dealer or an experienced radio/TV technician for help.

You are cautioned that any changes or modifications not expressly approved in this manual could void your authority to operate this equipment.

Only peripherals (computer input/output devices, terminals, printers, etc.) that comply with FCC Class B limits may be attached to this computer product. Operation with non-compliant peripherals is likely to result in interference to radio and television reception.

All cables used to connect peripherals must be shielded and grounded. Operation with cables, connected to peripherals, that are not shielded and grounded, may result in interference to radio and television reception.

FCC Part 68

This equipment complies with Part 68 of the FCC rules. On the bottom of this equipment is a label that contains, among other information, the FCC equivalence number (REN) for this equipment. If requested, this information must be provided to the telephone company.

This modem uses the USOC RJ-11 telephone jack.

The REN is used to determine the quantity of devices which may be connected to the telephone line. Excessive RENs on the telephone line may result in the devices not ringing in response to an incoming call. In most, but not all areas, the sum of the RENs should not exceed five (5.0). To be certain of the number of devices that may be connected to the line, as determined by the total RENs, contact the telephone company to determine the maximum REN for the calling area.

If the terminal equipment (Notebook Computer PCG-505TS/PCG-505TX) causes harm to the telephone network, the telephone company will notify you in advance that temporary discontinuance of service may be required. But if advance notice is not practical, the telephone company will notify the customer as soon as possible. Also, you will be advised of your right to file a complaint with the FCC if you believe it is necessary.

The telephone company may make changes in its facilities, equipment, operations or procedures that could affect the operations of the equipment. If this happens, the telephone company will provide advance notice in order for you to make the necessary modifications in order to maintain uninterrupted service.

If trouble is experienced with this equipment (Notebook Computer PCG-505TS/PCG-505TX), please contact 1-888-4SONYPC (1-888-476-6972), or write to the Sony Customer Information Center,

One Sony Drive, Park Ridge, NJ 07656 for repair and/or warranty information. If the trouble is causing harm to the telephone network, the telephone company may request that you remove the equipment from the network until the problem is resolved.

Repair of this equipment should be made only by a Sony Service Center or Sony authorized agent. For the Sony Service Center nearest you, call 1-888-4SONYPC (1-888-476-6972).

This equipment cannot be used on public coin service provided by the telephone company. Connection to Party Line Service is subject to state and possible provincial tariffs. (Contact the state or provincial utility service commission, public service commission or corporation commission for information.)

Telephone Consumer Protection Act of 1991 (United States)

The Telephone Consumer Protection Act of 1991 makes it unlawful for any person to use a computer or other electronic device to send any message via a telephone facsimile machine unless such message clearly contains, in a margin at the top or bottom of each transmitted page or on the first page of the transmission, the date and time it is sent and an identification of the business, other entity, or individual sending the message, and the telephone number of the sending machine or such business, other entity, or individual.

In order to program this information into your facsimile machine, see your fax software documentation.

Telephone Consumer Guidelines (Canada)

Please refer to your telephone directory under 'Privacy Issues' and/or 'Terms of Service'. For more detailed information please contact.

CRTC

Terrasses de la Chaudière, Tour centrale 1
promenade du Portage, 5 étage, Hull PQ
K1A 0N2.

This Class B digital apparatus complies with Canadian ICES-003.

Cet appareil numérique de la class B est conforme à la norme NMB-003 du Canada.

DISPOSAL OF LITHIUM ION BATTERY

You can return your unwanted lithium ion batteries to your nearest Sony Service Center or Factory Service Center.



In some areas the disposal of lithium ion batteries in household or business trash may be prohibited.

For the Sony Service Center nearest you call 1-888-476-6972 in the United States or 1-800-961-7669 in Canada.

! Do not handle damaged or leaking lithium ion batteries.

! Ne pas manipuler les batteries au lithium-ion qui fuient ou sont endommagées.

! Danger of explosion if battery is incorrectly replaced. Replace only with the same or equivalent type recommended by the manufacturer. Discard used batteries according to the manufacturer's instructions.

! Une batterie non conforme présente un danger d'explosion. La remplacer seulement par une batterie identique ou de type équivalent recommandé par le fabricant. Évacuer les batteries usées selon les directives du fabricant.

! The battery pack used in this device may present a fire or chemical burn hazard if mistreated. Do not disassemble, heat above 212° (100°C) or incinerate. Dispose of used battery promptly. Keep away from children.

! La manutention incorrecte du module de batterie de cet appareil présente un risque d'incendie ou de brûlures chimiques. Ne pas démonter, incinérer ou exposer à une température de plus de 100°C. Évacuer promptement la batterie usée. Garder hors de portée des enfants.

INDUSTRY CANADA NOTICE

NOTICE: The Industry Canada label identifies certified equipment. This certification means that the equipment meets certain telecommunications network protective, operational and safety requirements as prescribed in the appropriate Terminal Equipment Technical Requirements document(s). The Department does not guarantee the equipment will operate to the user's satisfaction.

Before installing this equipment, users should ensure that it is permissible to be connected to the facilities of the local telecommunications company. The equipment must also be installed using an acceptable method of connection.

The customer should be aware that compliance with the above conditions may not prevent degradation of service in some situations.

Repairs to certified equipment should be coordinated by a representative designated by the supplier. Equipment malfunctions or any repairs or alterations made by the user to this equipment may give the telecommunications company cause to request that the user disconnect the equipment.

Users should ensure for their own protection that the electrical ground connections of the power utility, telephone lines and internal metallic water pipe system, if present, are connected together. This precaution may be particularly important in rural areas.

Caution: Users should not attempt to make such connections themselves, but should contact the appropriate electric inspection authority, or electrician, as appropriate.

NOTICE: The Ringer Equivalence Number (REN) assigned to each terminal device provides an indication of the maximum number of terminals allowed to be connected to a telephone interface. The

termination on an interface may consist of any combination of devices subject only to the requirement that the sum of the Ringer Equivalence Number of all the devices does not exceed 5.

AVIS DE L'INDUSTRIE CANADA

AVIS: L'étiquette d'Industrie Canada identifie le matériel homologué.

Cette étiquette certifie que le matériel est conforme aux normes de protection, d'exploitation et de sécurité des réseaux de télécommunications, comme le prescrivent les documents concernant les exigences techniques relatives au matériel terminal. Le Ministère n'assure toutefois pas que le matériel fonctionnera à la satisfaction de l'utilisateur.

Avant d'installer ce matériel, l'utilisateur doit s'assurer qu'il est permis de le raccorder aux installations de l'entreprise locale de télécommunication. Le matériel doit également être installé en suivant une méthode acceptée de raccordement. L'abonné ne doit pas oublier qu'il est possible que la conformité aux conditions énoncées ci-dessus n'empêche pas la dégradation du service dans certaines situations.

Les réparations de matériel homologué doivent être coordonnées par un représentant désigné par le fournisseur. L'entreprise de télécommunications peut demander à l'utilisateur de débrancher un appareil à la suite de réparations ou de modifications effectuées par l'utilisateur ou à cause de mauvais fonctionnement.

Pour sa propre protection, l'utilisateur doit s'assurer que tous les fils de mise à la terre de la source d'énergie électrique, des lignes téléphoniques et des canalisations d'eau métalliques, s'il y en a, sont raccordés ensemble. Cette précaution est particulièrement importante dans les régions rurales.

Avertissement: L'utilisateur ne doit pas tenter de faire ces raccordements lui-même; il doit avoir recours à un service d'inspection des installations électriques, ou à un électricien, selon le cas.

AVIS: L'indice d'équivalence de la sonnerie (IES) assigné à chaque dispositif terminal indique le nombre maximal de terminaux qui peuvent être raccordés à une interface.

La terminaison d'une interface téléphonique peut consister en une combinaison de quelques dispositifs, à la seule condition que la somme d'indices d'équivalence de la sonnerie de tous les dispositifs n'exécède pas 5.

Contents

Welcome

Ergonomic Considerations	2
--------------------------------	---

Using Your 505 SuperSlim Notebook

Locating the Controls and Connectors	5
Front.....	5
Back	6
Left	6
Right.....	7
Bottom	7
Connecting a Power Source	8
Using the AC Adapter.....	8
Using Battery Power.....	9
Starting Your Computer	12
Shutting Down Your Computer	13
Registering Windows 98.....	14
Registering Your Computer	15
Using the Keyboard.....	16
Combinations and Functions with the Windows 98 Key	18
Indicators.....	19
Combinations and Functions with the Fn Key	20
Using the Touchpad	21
Using the Plastic Pen	22
Using ScribblePad.....	23
Using the Floppy Disk Drive	24
Using PC Cards	26
Using Infrared Communication Devices.....	29
Using Power Saving Modes	31

Normal Mode	31
System Suspend Mode	31
System Hibernation Mode	32

Connecting Peripheral Devices

Connecting a Phone Line	34
Connecting the Port Replicator	35
Connecting a Printer	37
Connecting an External Display	38
Connecting an External Mouse and Keyboard	40
Connecting a Desktop Computer or Serial Device	41
Connecting the CD-ROM Drive	43
Connecting External Speakers	46
Connecting a Digital Video Camera Recorder	48
Connecting a Universal Serial Bus (USB) Device	49

Customizing Your Notebook Computer

Displaying the Sony Notebook Setup Screen	51
Notebook Setup Tabs	52
Controlling Power Management	53
Power Management Profiles	53
Power Management Commands	54
Displaying Battery Information	57
Activating BatteryScope	57
Battery Icon Descriptions	57
Displaying Detailed Battery Information	58
Starting Your Favorite Software With Programmable Power Key (PPK) Setup	59
Using the Programmable Power Key With Other Keys	60
Selecting the Display Mode	61

Getting Help

Troubleshooting	65
Using the System and Application Recovery CDs	71
Using the System Recovery CD(s)	71
Using the Application Recovery CD(s)	73

<i>Notes on Use</i>	75
<i>Limited Warranty Statement</i>	
VAIO 505 SuperSlim Notebook Computer Warranty	81
GARANTIE RESTREINTE.....	83
Battery Limited Warranty.....	85
GARANTIE RESTREINTE.....	85
<i>Index</i>	87

Welcome

Congratulations on your purchase of the Sony VAIO® 505 SuperSlim Notebook. Sony has combined leading-edge technology in audio, video, computing, and communications to provide you with state-of-the-art personal computing.

This manual offers a quick introduction and reference to your Sony computer.

- ❑ **Using Your 505 SuperSlim Notebook** shows you how to use the standard components of your system.
- ❑ **Connecting Peripheral Devices** explains how you can add functionality by connecting various peripherals.
- ❑ **Getting Help** explains the support options available to you, shows you how to use the Sony Customer Support service, and offers basic troubleshooting tips.
- ❑ **Notes on Use** provides facts and advice about using your notebook computer.
- ❑ **Limited Warranty Statement** provides your product warranty statement and explains how to extend your warranty for an additional nine months.

The online version of the *User Guide* is included with your computer as an electronic document. It includes additional information on customizing your notebook computer.

Ergonomic Considerations

You will be using your notebook computer as a portable device in a variety of environments. Whenever possible, you should attempt to apply the following ergonomic considerations to both stationary and portable environments.

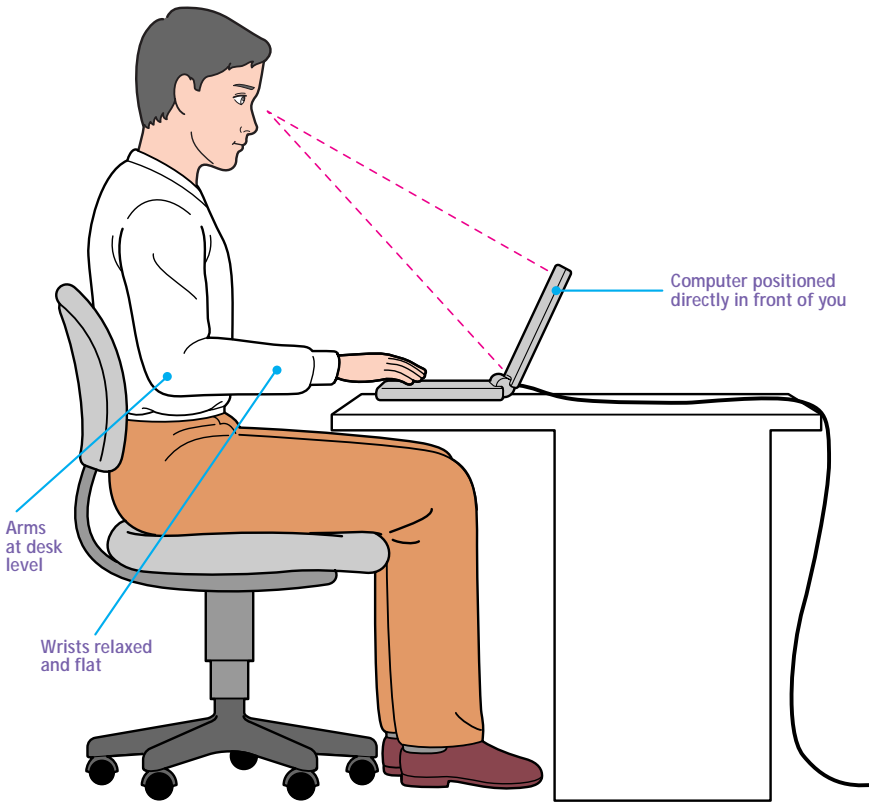

- ❑ **Position of your computer** – Place the computer directly in front of you as you work. Keep your forearms horizontal, with your wrists in a neutral, comfortable position while using the keyboard, touchpad, or external mouse. Let your upper arms hang naturally at your sides. Take breaks during sessions with your computer. Excessive use of the computer may strain muscles or tendons.

- ❑ **Furniture and posture** – Sit in a chair with good back support and armrests. Adjust the level of the chair so your feet are flat on the floor. A footrest may make you more comfortable. Sit in a relaxed, upright posture and avoid slouching forward or leaning far backward.
- ❑ **Viewing angle of the computer's display** – Use the display's tilting feature to find the best position. You can reduce eye strain and muscle fatigue by adjusting the tilt of the display to the proper position. Adjust the brightness settings of the display also.
- ❑ **Lighting** – Choose a location where windows and lights do not create glare and reflection on the display. Use indirect lighting to avoid bright spots on the display. You can also purchase accessories for your display that help reduce glare. Proper lighting adds to your comfort and work effectiveness.
- ❑ **Placement of an external display** – When using an external display, set the display at a comfortable viewing distance. Make sure the display screen is at eye level or slightly lower when you are sitting in front of the monitor.

Using Your 505 SuperSlim Notebook

This section describes how to start using your computer and how to use your computer's internal and external devices, such as the touchpad and floppy disk drive.

Locating the Controls and Connectors

Front

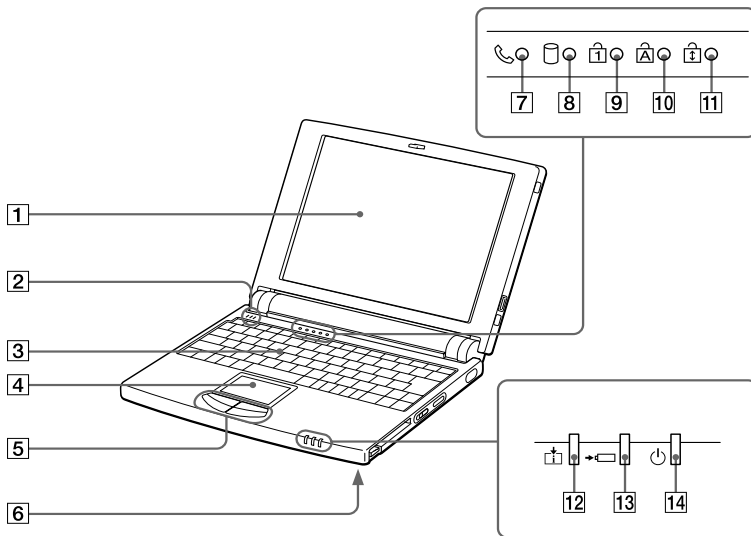

- 1 LCD screen (pages 20, 75)
- 2 Microphone
- 3 Keyboard (page 16)
- 4 Touchpad (page 21)
- 5 Left/right button (page 21)
- 6 Speaker (page 46)
- 7 Modem indicator (page 19)

- 8 Hard disk drive indicator (page 19)
- 9 Num Lock indicator (page 19)
- 10 Caps Lock indicator (page 19)
- 11 Scroll Lock indicator (page 19)
- 12 Information indicator (page 19)
- 13 Battery indicator (pages 10, 19, 57)
- 14 Power indicator (pages 12, 19)

Back

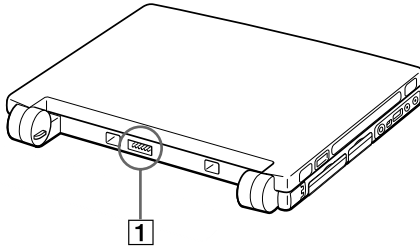

- 1 Battery connector (page 9)

Left

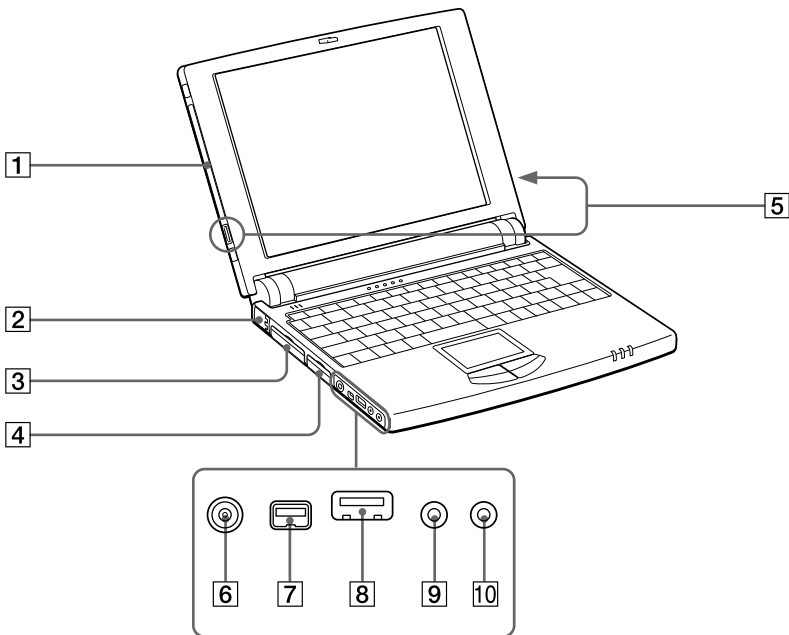

- | | | | |
|---|---|----|-----------------------------------|
| 1 | Plastic pen holder (page 22) | 6 | DC In connector (page 8) |
| 2 | Phone line jack (page 34) | 7 | 200 i.LINK™ (IEEE1394) (page 48) |
| 3 | I/O Port replicator connector (page 35) | 8 | USB connector (page 49) |
| 4 | Floppy disk drive connector (page 24) | 9 | Line In connector |
| 5 | External speaker connectors (page 46) | 10 | Headphone connector (page 47) |

Right

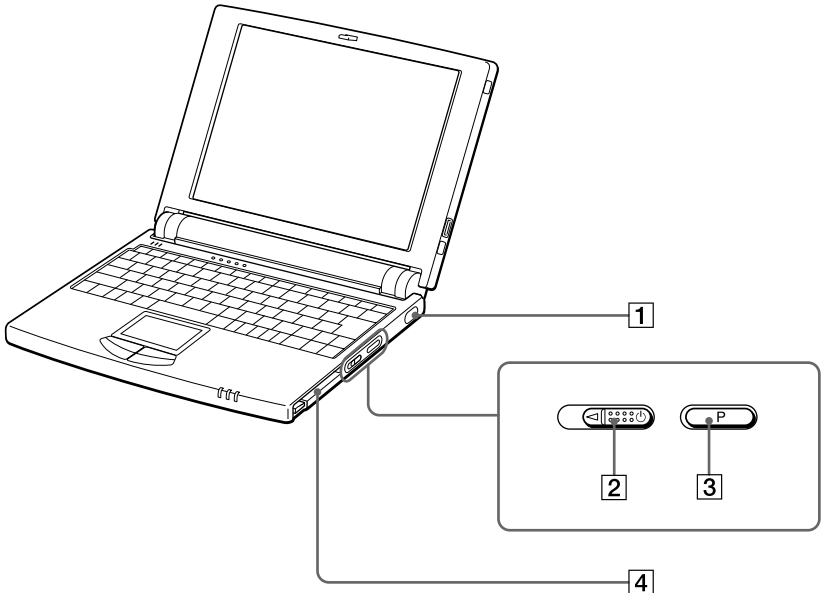

1 Infrared port (page 29)

2 Power switch (page 12)

3 Programmable Power Key (page 59)

4 PC card slot (page 26)

Bottom

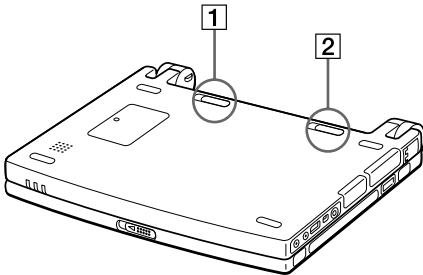

1 Battery release lever (pages 9, 11)

2 Battery lock lever (pages 9, 11)

Connecting a Power Source

You can use either AC power or a rechargeable battery pack as a power source.

Using the AC Adapter

- 1 Plug the cable attached to the AC adapter into the DC In connector on the computer.
- 2 Pull the prong on the AC adapter upwards and plug it into an AC outlet.

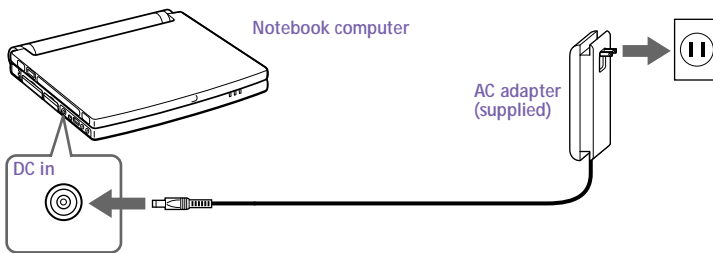

To remove the AC adapter

- 1 Unplug the AC adapter from the AC outlet and the adapter cable from the DC In connector on the computer.
- 2 Align the adapter cable with the groove on the AC adapter and wrap the cable around the AC adapter.

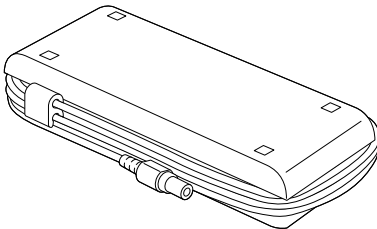

Using Battery Power

You can use a battery pack as a source of power. The PCGA-BP51 battery pack that comes with your computer is not fully charged at the time of purchase. Follow the steps below to insert and charge the battery pack.

 You can also purchase the high-capacity PCGA-BP52 battery pack as a separate option. See “Using Power Saving Modes” on page 31 for power management information.

To insert the battery pack

- 1 Move the lock lever on the bottom of the computer to the **UNLOCK** position.

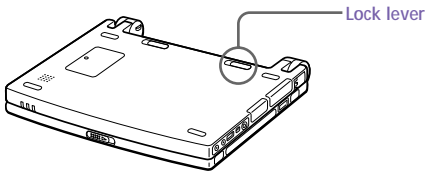

- 2 Align the grooves and tabs on the battery with the tabs and notches on the back of the computer, and then slide the battery towards the computer until it clicks into place.

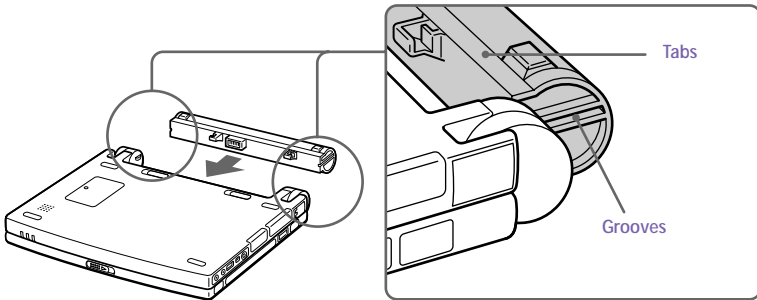

- 3 Slide the lock lever into the **LOCK** position to secure the battery on the computer.

To charge the battery pack

- 1 Connect the AC adapter to the computer.
- 2 Insert the battery pack.

The computer automatically charges the battery (the battery indicator light flashes in a double blink pattern as the battery charges). When the battery is 85% full, the battery indicator light turns off. This process takes approximately one and one half hours. To charge the battery completely, continue charging for an additional hour.

A fully charged battery pack provides power for:

<i>Model</i>	<i>PCGA-BP51</i>	<i>PCGA-BP52</i>
PCG-505TX	Approx. 1.5 to 2.5 hours	Approx. 3.0 to 6.0 hours
PCG-505TS	Approx. 1.5 to 3.0 hours	Approx. 3.0 to 7.0 hours

The time varies based on your system configuration. See “Displaying Detailed Battery Information” on page 58 for details on checking the battery life.

The  battery indicator light on the front of the computer indicates the status of the battery pack.

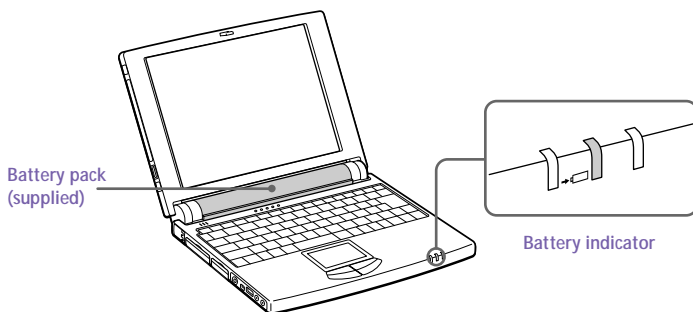

Battery Indicator

Light Status

Meaning

On	The computer is using battery power.
Single blink	The battery is running out of power.
Double blink	The battery is charging.
Off	The computer is using AC power.

 Both the battery and power indicators blink when the battery is running out of power.

Keep the battery pack in the computer while it is directly connected to AC power. The battery pack continues to charge while you are using the computer.

If your battery level falls to less than 10%, you should either attach the AC adapter to recharge the battery or shut down your computer and insert a fully charged battery.

You can extend battery life by changing the power management modes in the PowerPanel utility. See “Using Power Saving Modes” on page 31.

The battery pack supplied with your computer is a lithium ion battery and can be recharged at any time. Charging a partially discharged battery does not affect battery life.

The battery indicator light is on while you use the battery pack as a power source. When battery life is nearly depleted, the battery indicator starts flashing.

For some software applications and some peripheral devices, your computer may not enter System Hibernation mode when the battery life is low. To avoid loss of data when using battery power, you should save your data frequently and manually activate a power management mode, such as System Suspend or System Hibernation.

To remove the battery pack

- 1 Turn off the computer.**
- 2 Slide the lock lever to the **UNLOCK** position.**
- 3 Slide the release lever to the **UNLOCK** position and slide the battery away from the computer.**

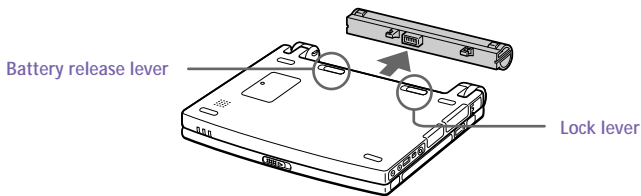

 You may lose data if you remove the battery pack while the computer is on and not connected to the AC adapter or if you remove the battery while the computer is in System Suspend mode.

Starting Your Computer

- 1 Slide the LCD lock lever in the direction of the arrow, and lift the cover.

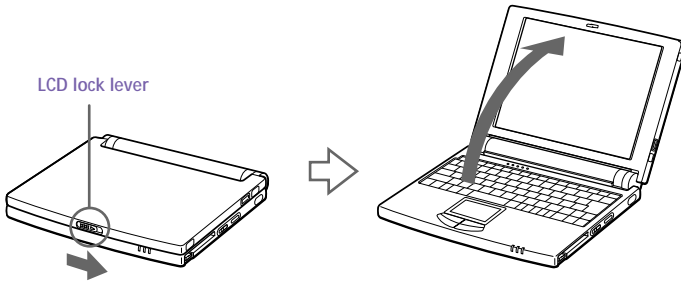

- 2 Slide the power switch on the right side toward the front of the computer until the green power indicator light turns on.

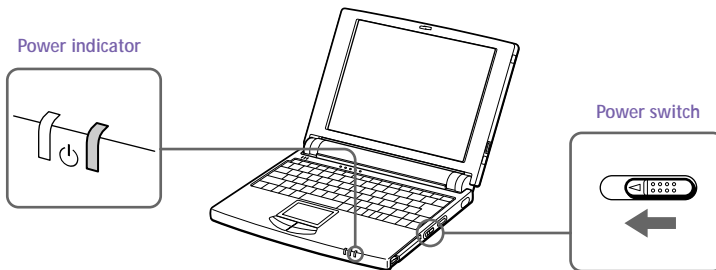

If you hold the power switch in the on position for more than four seconds, the computer turns off.

- 3 If necessary, adjust the brightness controls for the LCD display. To decrease the brightness, press **Fn+F5** and then the down or left arrow key. To increase the brightness, press **Fn+F5** and then the up or right arrow key.

Shutting Down Your Computer

! To avoid potential loss of data, follow these steps to shut down your computer.

- 1 Click the Start button on the Windows® 98 taskbar.
- 2 Click Shut Down at the bottom of the Start menu to display the Shut Down Windows dialog box.



- 3 Select Shut down.
- 4 Click OK.

 Respond to any prompts warning you to save documents.

- 5 Wait for your computer to turn off automatically. The power indicator turns off.
- 6 Turn off any peripherals connected to your computer.

 If you are unable to shut down your computer using the steps described above, press the Ctrl+Alt+Delete keys at the same time to restart the computer. If you are unable to restart the computer in this way, you can slide the power switch forward and hold for four seconds. This operation may result in data loss.

During a period of inactivity, you can conserve battery life by using System Suspend mode. See "Controlling Power Management" on page 53.

Registering Windows 98

The first time you turn on your computer, you need to complete a few steps to register and configure the Windows 98 software that is already installed on your computer.



You must register Windows 98 before you can use the computer.

The on-screen instructions guide you through the registration and configuration process. The following is an overview of the process.

- 1 Gathering information:
 - ❑ Enter your name.
 - ❑ Read and accept the License Agreement.
 - ❑ Enter your Certificate of Authenticity number located on the cover of the Microsoft Windows 98 *Getting Started* manual.
- 2 Windows 98 setup: Click the Finish button on the Windows 98 Setup Wizard screen.
- 3 Selecting your computer settings: If necessary, change the Time Zone, Date and Time on the Date/Time Properties screen.
- 4 Registering your computer: For details on the benefits of registration, see “Registering Your Computer” on page 15. You can also sign up for your 100 free hours of Internet service at this time.
- 5 Learning about Windows 98: If you wish, take the tour of Windows 98.

Registering Your Computer

You can take advantage of Sony's commitment to quality customer support and receive the following benefits by registering your computer with Sony:

- ❑ **Sony Customer Support** – Talk to a Support Representative to troubleshoot problems you may be having with your computer.
- ❑ **Extended Limited Warranty** – Protect your investment. Extend your Warranty nine months for a total of 12 months from the original date of purchase when you register your computer.
- ❑ **Express service** – Provides convenient resolution of problems.
- ❑ **Free Internet access** – Use the Internet for up to 100 free hours when you sign up with GTE (no credit card necessary). Free access expires 100 hours or 60 days after signing up, whichever occurs first.

If you have not already registered, follow these steps to use your notebook computer's online registration service.



You must connect your phone line before using any online services, including the online registration service. See "Connecting a Phone Line" on page 34.

- 1 Click the Sony VAIO Registration icon on the VAIO desktop.
- 2 Enter the information requested on the first online registration form. Press the Tab key to move from box to box.
- 3 Click the Next button to advance to the next form.
- 4 Complete the remaining forms by clicking the Next button each time you complete a form.

The computer automatically transfers your registration information using your built-in modem and a toll-free telephone number.

Using the Keyboard

Your keyboard is very similar to a typewriter's, but the keyboard has additional keys that perform specific computer-related tasks.

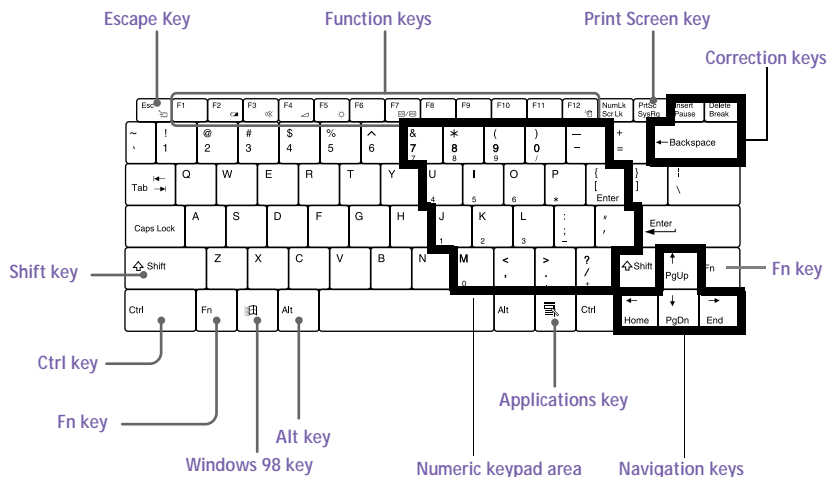

Keys

Descriptions

Numeric keypad area

Contains the keys found on a typical calculator. Use the numeric keypad area to type numbers or to perform mathematical calculations such as addition and subtraction. Note that you must press the Num Lock key to activate the numeric keypad. (When you do so, the Num Lock light will be on.)

Navigation keys



Several keys are devoted to moving the cursor on the screen (the four arrow keys which also function as the Home, End, Page Up, and Page Down keys).

Correction keys









The Insert, Back Space, and Delete keys enable you to make corrections in your documents.

Function keys



The twelve function keys along the top of the keyboard are used to perform designated tasks. For example, in many applications, F1 is the Help key. The task associated with each function key may vary from one application to the next.





<i>Keys</i>	<i>Descriptions</i>
Escape key	The Esc (Escape) key is used to cancel commands
Print Screen key	The Print Screen key takes an electronic snapshot of the screen and places it in the Windows Clipboard. You can then paste the screen shot into a document and print it.
Operator keys	Several keys are always used with at least one other key: Ctrl, Alt, and Shift. When held down with another key, the Ctrl (Control) and Alt (Alternate) keys offer another way to give commands. For example, in many applications, instead of choosing the Save command from a menu, you can hold down Ctrl and press S (referred to as Ctrl+S). The Shift key operates the same way as on a typewriter; it's used to produce capital letters or special symbols such as @ and \$.
Windows 98 key 	The key with the Windows logo displays the Windows 98 Start menu; it's the equivalent of clicking the Start button on the task bar. See "Combinations and Functions with the Windows 98 Key" on page 18.
Fn key	The Fn key is used in combination with other keys to issue commands. The Fn keys at the left and right sides both work the same. See "Combinations and Functions with the Fn Key" on page 20.
Applications key 	The Applications key displays a shortcut menu of context-sensitive choices; pressing this key is the equivalent of clicking the right mouse button.

Combinations and Functions with the Windows 98 Key











<i>Combinations</i>	<i>Functions</i>
 + F1	Displays Windows Help.
 + Tab	Switches the selected button on the taskbar.
 + E	Displays Windows Explorer.
 + F	Displays the Windows Find: All Files window to find a file or folder. This is the equivalent of selecting Find and then Files or Folders from the Start menu.
 + Ctrl + F	Displays the Windows Find: Computer window where you can locate other computers. This is the equivalent of selecting Find and then Computer from the Start menu.
 + M	Minimizes all displayed windows.
Shift +  + M	Returns all minimized windows to their previous size.
 + R	Displays the Run window. This is the equivalent of selecting Run from the Start menu.
Fn +  + Insert	Displays the Properties window. This is the equivalent of double-clicking the System icon in the Control Panel.

Indicators

<i>Indicators</i>	<i>Functions</i>
Information 	Turns on when the PPK Timer is set. Turns off when the PPK Timer is not set or the PPK Timer setting is inactive. (Such as when the computer's power is off or in System Hibernation mode.)
Battery 	Indicates the status of the battery attached at the rear of the computer.
Power 	Lights when the power to the computer is turned on. Flashes in System Suspend mode. Turns off when the computer is in System Hibernation mode or powered off.

<i>Light</i>	<i>On</i>	<i>Off</i>
Modem 	The modem is in use.	The modem is not in use.
Hard disk 	Data is being read from or written to the hard drive. Do not enter System Suspend mode or turn off the computer when this indicator light is on.	The hard drive is not being accessed.
Num Lock 	The number keys in the numeric keypad are active.	The character keys in the keypad area are active.
Caps Lock 	The letters appear in uppercase as you type. The Shift key lowers the case of typed letters when Caps Lock is on.	Letters appear in lower case as you type (unless you hold down the Shift key).
Scroll Lock 	The screen scrolls differently. (Exactly how it scrolls depends on the specific application. It has no effect in many applications.)	Information moves across the display normally.

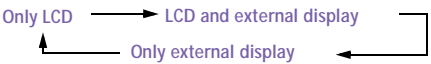
Combinations and Functions with the Fn Key

Combinations/ Feature	Functions
Fn+  (ESC) System Suspend	Puts the system into System Suspend mode, a power management state. To return the system to the active state, press any key or press the power switch on your computer.
Fn+  (F2) Display power status	Displays the power status, as in the example below: <div style="text-align: center; margin-top: 10px;">  </div>
Fn+  (F3) Speaker switch	Toggles the built-in speaker off and on.
Fn+  (F4) Speaker volume	Adjusts the built-in speaker volume. To increase volume, press Fn+F4, then ↑ or → . To decrease volume, press Fn+F4, then ↓ or ← .
Fn+  (F5) Brightness control	Adjusts the brightness of the LCD. To increase light intensity, press Fn+F5 and then ↑ or → . To decrease light intensity, press Fn+F5 and then ↓ or ← .
Fn+  (F7) Switch to the external display	Toggles through the LCD, external display (connected to the  Monitor connector on the port replicator) and both LCD and external display. <div style="text-align: center; margin-top: 10px;">  </div>
Fn+  (F12) System Hibernation	Provides for the lowest level of power consumption. When you execute this command, the state of the system and state of the peripheral devices are written to the hard disk and the system power is turned off. To return the system to the original state, use the power switch to turn on power.
Fn+D Video standby	Turns off the LCD in order to save power.
Fn+F Change the display size	Zooms the display size in or out when the display is set to less than maximum resolution.

Using the Touchpad

The keyboard contains a cursor-pointing device called a touchpad. You can point to, select, drag, and scroll objects on the screen using the built-in touchpad.

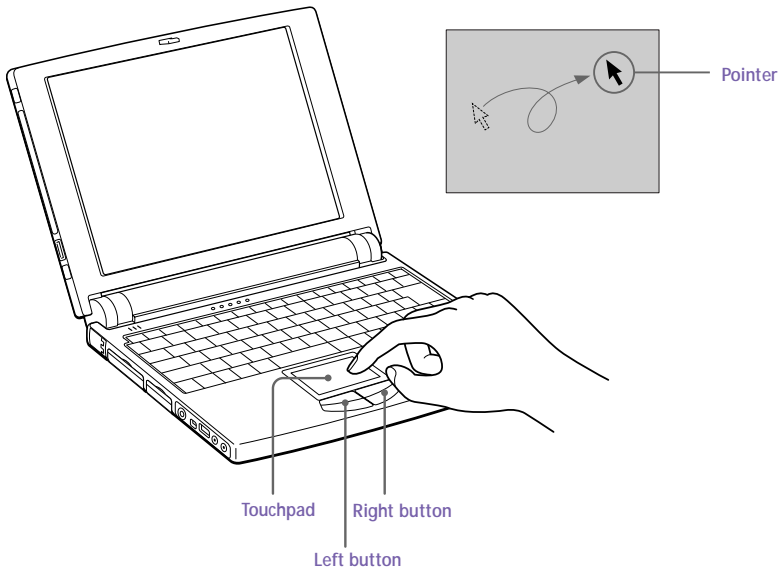

<i>Actions</i>	<i>Descriptions</i>
Point	Slide one finger on the touchpad to place the pointer on an item or object.
Click	Press the left button once.
Double-click	Press the left button twice.
Right-click	Press the right button once. In many applications, this action displays a shortcut menu of context-sensitive choices.
Drag	Slide one finger while pressing the left button.
Scroll	Move your finger along the right edge of the touchpad.



The scroll function is available only with applications that support a touchpad scroll feature.

Using the Plastic Pen

The plastic pen can be used on the touchpad for drawing or for signing your name with the ScribblePad software. You can store the pen in the pen holder on the left side of the LCD screen. The method for inserting and removing the pen differs, depending on your model.

To use the pen compartment for the PCG-505TS SuperSlim Notebook

- 1 Press the bottom of the pen compartment to open the compartment.

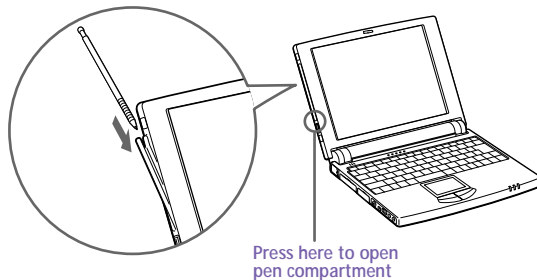

- 2 Slide the pen in or out of the compartment to store or remove it.
- 3 When you are ready to close the pen compartment, press the top of the compartment until it clicks into place.

To use the pen slot for the PCG-505TX SuperSlim Notebook



For the PCG-505TX, the pen is stored in a slot. To insert the pen, put the tip of the pen into the bottom end of the slot, then press the pen into the slot. To remove the pen, press the pen down and pull it out.



The supplied plastic pen is designed to be used only on the touchpad. Do not use this pen on any surface other than the touchpad including the computer's LCD; it may damage the LCD.

Store the pen in the pen compartment when you are not using it.

Using ScribblePad

ScribblePad is an application that lets you create memos by writing on the touchpad using the supplied plastic pen.

To use ScribblePad

- 1 Click the Start button on the Windows 98 taskbar.
- 2 Point to Programs, point to Sony Stationery, and then click ScribblePad.
- 3 Press the F10 key.

ScribblePad enters tablet mode. In this mode the touchpad corresponds with the ScribblePad screen. This means that what you write on the touchpad appears on the screen in the corresponding location. For example, when you write letters on the left corner of the touchpad, the letters appear on the left corner of the screen.

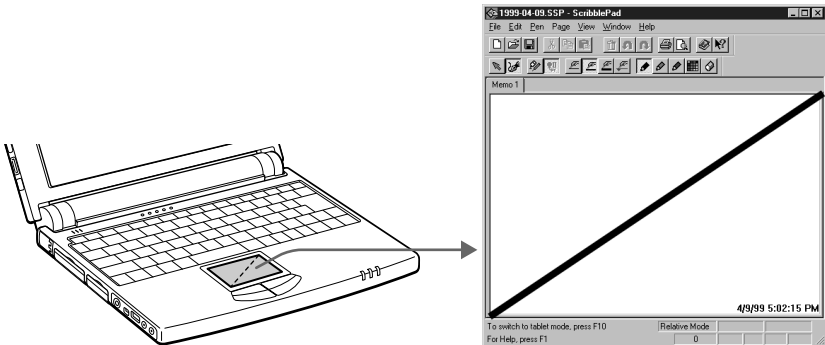

- 4 To write, move the pen slowly on the touchpad.

As you write, the letters you wrote on the touchpad appear on the screen.





To learn more about ScribblePad, click Help on the ScribblePad screen to display the online help file.

Using the Floppy Disk Drive

You can connect the floppy disk drive to the FDD connector on your computer:

To connect the floppy disk drive

- 1 Turn off the computer.
- 2 Open the cover of the  Floppy disk drive connector.
- 3 Plug the floppy disk drive cable into the  FDD connector. The VAIO logo on the disk drive should be facing up.

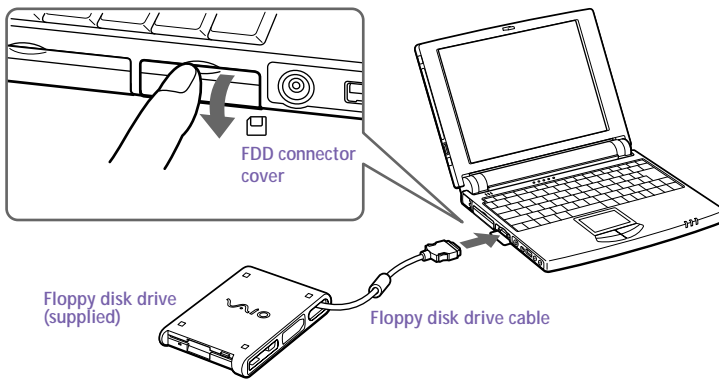

To insert a diskette

- 1 Hold the diskette with the label side facing up.
- 2 Gently push the diskette into the drive until it clicks into place.

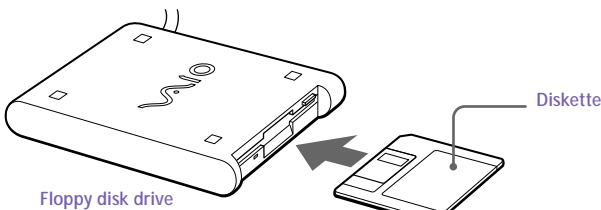

To remove a diskette

- When you finish using the diskette, wait until the LED indicator turns off and then press the Eject button to remove the diskette.

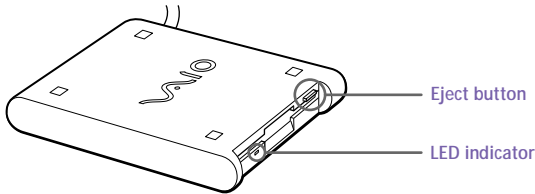
*To remove the floppy disk drive*

- 1 Turn off the computer.
- 2 Press both sides of the floppy disk drive cable and unplug the cable from the computer.

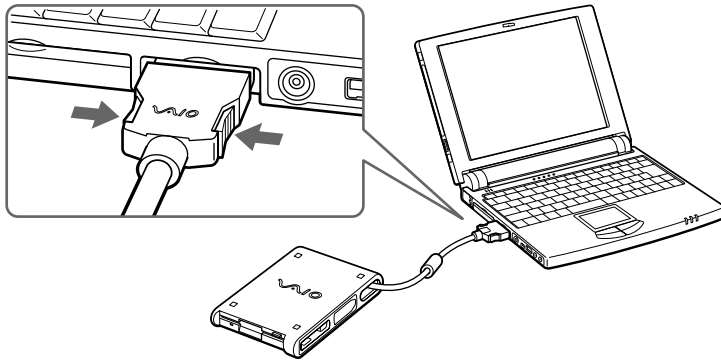

- 3 Fold the floppy disk drive cable into the compartment on the side of the floppy disk drive.

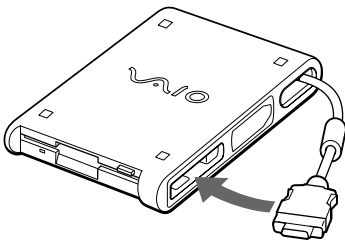

Using PC Cards

Your computer includes a PC card slot. PC cards allow you to connect portable external devices, such as a CD-ROM drive, or to connect to a network.

 The PC card slot can accommodate one Type II PC card. This slot is compatible with Card Bus and ZV (Zoomed Video) port.

Some PC cards may require that you disable idle devices when using the PC card. You can use Sony Notebook Setup to disable devices. See "Displaying the Sony Notebook Setup Screen" on page 51 for details.

Be sure to use the most recent software driver provided by the PC card manufacturer.

If an "!" mark appears on the Device Manager tab in the System Properties dialog, remove the software driver and then reinstall it.

To insert a PC card

 You do not need to shut down the computer before inserting or removing a PC card.

- 1 Pull the PC card release button up away from the computer and push it in towards the computer.

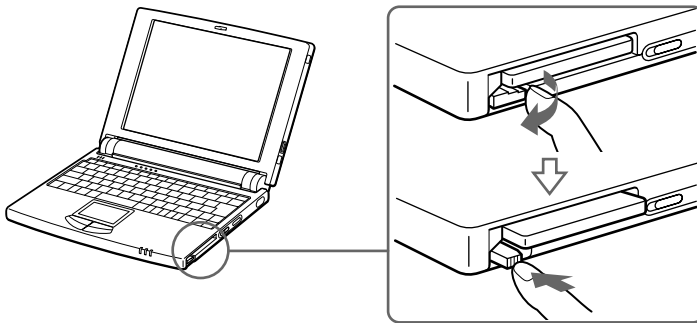

- 2 Remove the PC card slot protector.

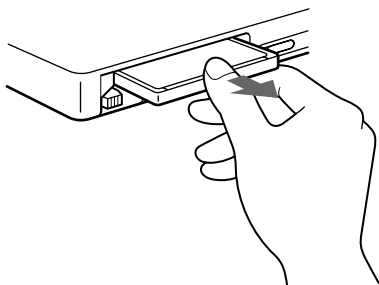

- 3 Insert the PC card into the PC card slot, front label facing up. Gently push the card into the slot until the card is fixed into the connector. The release button comes out.

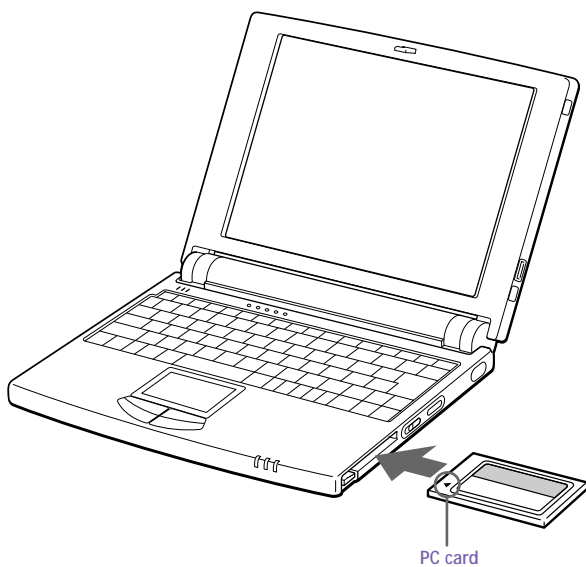

Do not force a card into the slot. It may damage the connector pins.

If you have difficulty inserting a card, check that you are inserting the card with the correct orientation.

See the manual that came with your PC card for more information on its use.

For some PC cards, if you alternate between normal power operation and the system suspend or system hibernation power management modes while the card is inserted, you may find that a device connected to your system is not recognized. Reboot your system to correct the problem.

To remove a PC card

- 1 Close any applications that use the PC card. Otherwise data may be lost.
- 2 Click the PC card icon in the taskbar and close the card.
- 3 Pull the PC card release button up and press it in towards the computer.

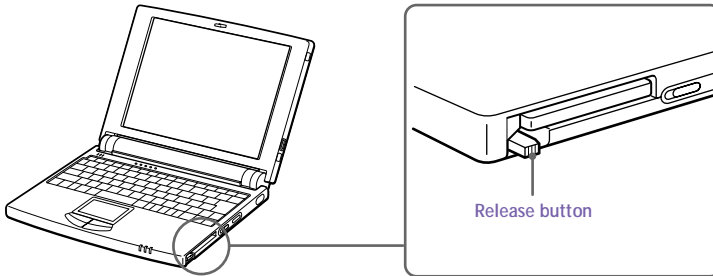

- 4 Gently grasp the card and pull it out.
- 5 Insert the PC card slot protector into the empty slot.

Using Infrared Communication Devices

Your computer includes an infrared port, located on the right side of the computer. You can use this port to communicate with other infrared-equipped devices with compatible protocols, such as a digital still camera or other computers.

To use infrared communication with a digital still camera

Align the infrared ports on the computer and the digital camera so that they are in a direct line.

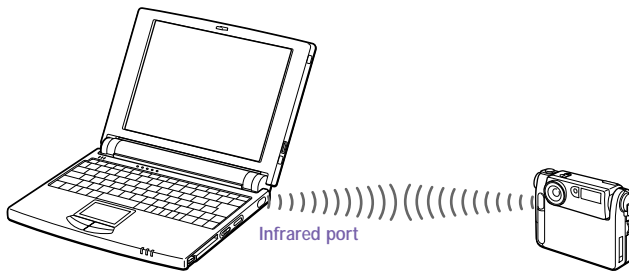

To use infrared communication with another computer

Align the infrared ports on the two computers so that they are in a direct line.

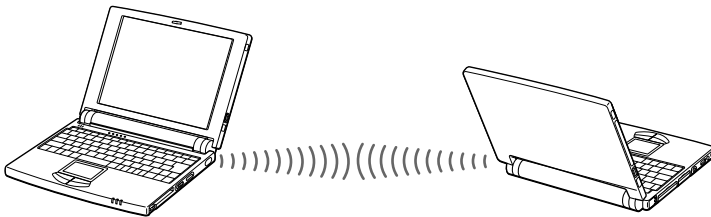

Infrared communication capability can be turned on and off. By default, it is not enabled when your system is shipped. To enable infrared use, click the Infrared icon in the Windows Control Panel, and select the Enable infrared communication checkbox on the Options tab.

You can disable infrared communication when you are not using it to conserve battery life.

Use the Infrared icon in the Windows Control Panel to enable and disable infrared communication. Do not use the icon in the taskbar.

When you transfer files directly from devices other than the internal hard disk drive, such as a CD-ROM drive or hard disk drive on a network, set the System Suspend and System Hibernation timers to off.

Check the Status tag of the Infrared Monitor in the Windows Control Panel to determine if the infrared device is detected.

If the two devices are too far apart or too close together, data transfer may be interrupted or there may be noise in the transmission.

Do not cover the infrared ports with your hand or any other objects.

Avoid direct sunlight, fluorescent light, or flashing incandescent light near the infrared ports.

See the manual that came with your digital still camera or other infrared communication device for more information on installation and use.

The active area of infrared transmission extends about $39\frac{3}{8}$ inches (1m) with a radius of 15 degrees.

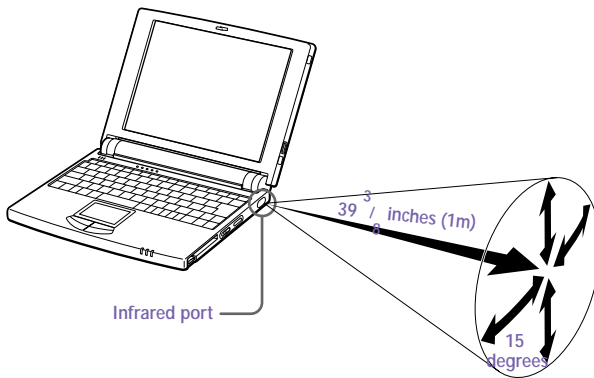

Using Power Saving Modes

When you use a battery as the source of power for your computer, you can take advantage of power management settings to conserve battery life. In addition to the normal operating mode, which allows you to turn off specific devices, your computer has two distinct power saving modes: System Suspend and System Hibernation. When using battery power, you should be aware that the computer automatically enters System Hibernation mode when the remaining battery charge drops below 5%, regardless of the power management setting you select.



If your battery level falls to less than 10%, you should either attach the AC adapter to recharge the battery or shut down your computer and insert a fully charged battery.

Normal Mode

This is the normal state of your computer when it is in use. The green power indicator light is on in this mode. To save power, you can turn off a specific device such as the LCD or the hard disk.



For details, see “Controlling Power Management” on page 53.

System Suspend Mode

The computer saves the current state of the system in RAM and switches off power to the CPU. The amber power indicator light flashes in this mode.

To activate System Suspend mode

Press Fn+Esc, or you can slide the power switch forward and release the switch immediately. You can also use the PowerPanel utility to enter System Suspend mode.

To return to normal mode

Press any key.

System Hibernation Mode

The state of the system is saved on the hard drive and power is turned off. The power indicator light is off in this mode.

To activate System Hibernation mode

Press Fn+F12. The “Save to Disk Manager” screen appears, and then the computer enters System Hibernation mode. You can also use the PowerPanel utility to enter System Hibernation mode.

To return to normal mode

Turn on the computer by sliding the power switch forward. The computer returns to its previous state.



When returning from System Hibernation mode, the system status stored on the hard disk is erased and the computer starts normally if you slide the power switch forward and hold for more than four seconds.

- ❑ **Time to return to normal mode:**
System Suspend requires less time than System Hibernation
- ❑ **Power consumption:**
System Suspend uses more power than System Hibernation

Connecting Peripheral Devices

You can add functionality to your computer by connecting any of these peripherals:

- ❑ Phone line (page 34)
- ❑ Port replicator (page 35)
 - ❑ Printer (page 37)
 - ❑ External display (page 38)
 - ❑ External mouse or keyboard (page 40)
 - ❑ Desktop computer or serial device (page 41)
- ❑ CD-ROM drive (page 43)
- ❑ External speakers (page 46)
- ❑ Digital video camera recorder (page 48)
- ❑ Universal Serial Bus (USB) device (page 49)



Turn off the computer before connecting peripherals. In normal use, you should turn on the peripherals before turning on the computer. You can connect USB devices while the computer is on.

Connect the AC adapter only after connecting all cables.

Connecting a Phone Line

You need to connect a phone line to take advantage of online services, the Internet, and Sony Customer Support.

 In order to register your Sony VAIO 505 SuperSlim Notebook, register your software online, and use Sony Customer Support, you must connect to a phone line. Also, you must register your computer to receive the extended warranty.

- 1 Open the phone line jack cover. The cover opens only to a 45 degree angle.

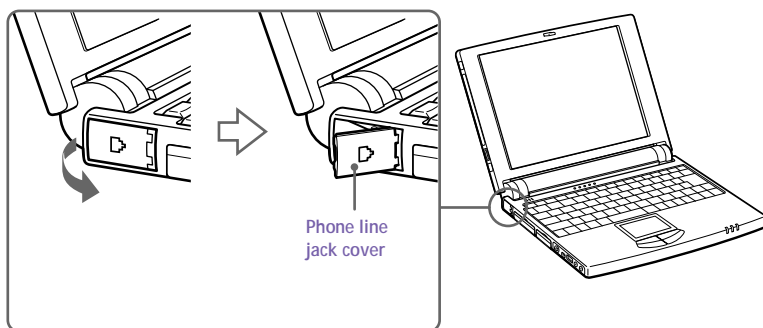

- 2 Plug one end of the phone cable into the jack on the inside of the phone line jack cover. Make sure you insert the phone cable from the rear of the computer and that the modular jack clicks into place.
- 3 Plug the other end into the wall jack.

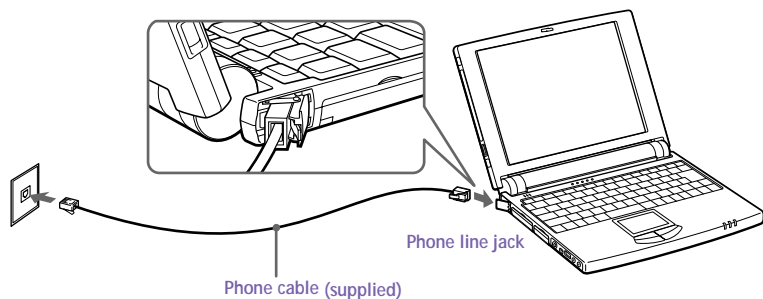

 Your computer does not work with party lines, cannot be connected to a coin-operated telephone, and may not work with multiple phone lines or a private branch exchange (PBX). Some of these connections might result in excess electrical current and could cause a malfunction in the internal modem.

Connecting the Port Replicator

You can use the PCGA-PR5 port replicator (supplied) to connect peripheral devices such as a printer or external display.

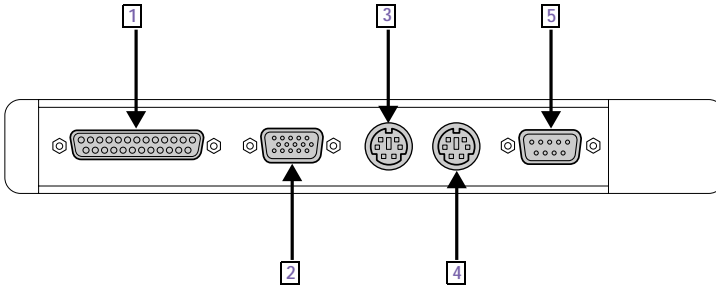

1  Printer (page 37)

2  Monitor (page 38)

3  Mouse (page 40)

4  Keyboard (page 40)

5  Serial (page 41)

To attach the port replicator

- 1 Turn off the computer.
- 2 Open the port replicator connector cover on the left side of the computer.

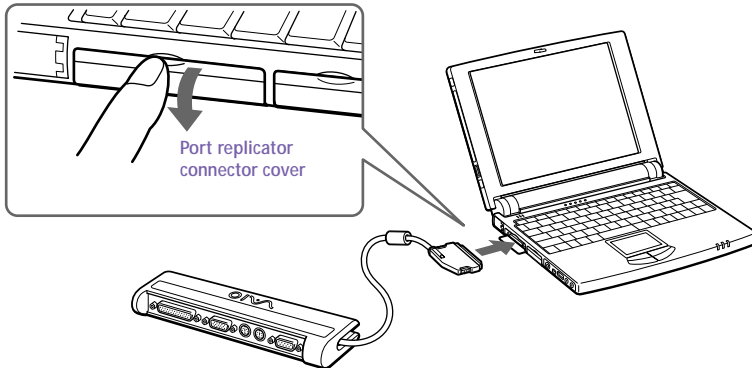

- 3 Plug the port replicator cable into the port replicator connector on the computer.

To remove the port replicator

- 1 Turn off the computer.
- 2 Press both sides of the port replicator cable and unplug the cable from the computer.

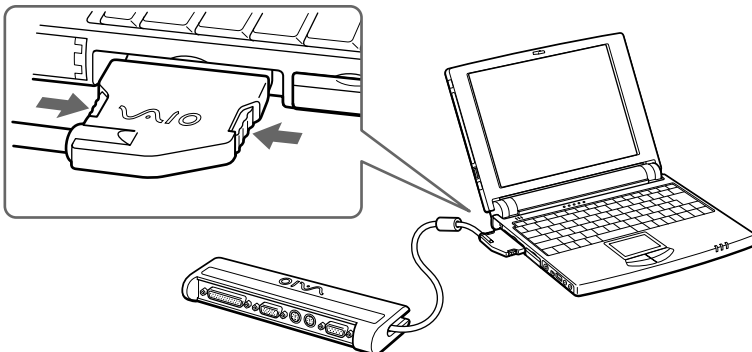

- 3 Fold the port replicator cable into the compartment on the side of the port replicator.

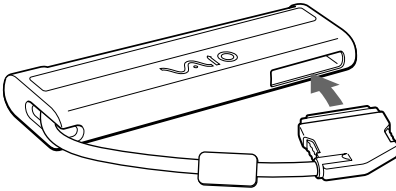

 If you do not turn off the computer before removing the port replicator, you must turn off the computer before reattaching the port replicator.

Connecting a Printer

You can use the port replicator to connect a Windows 98-compatible printer or other parallel port device to your computer.

To connect a printer

- Use the  symbol to locate the Printer connector on the port replicator. Plug the printer cable (supplied with the printer) into this connector.

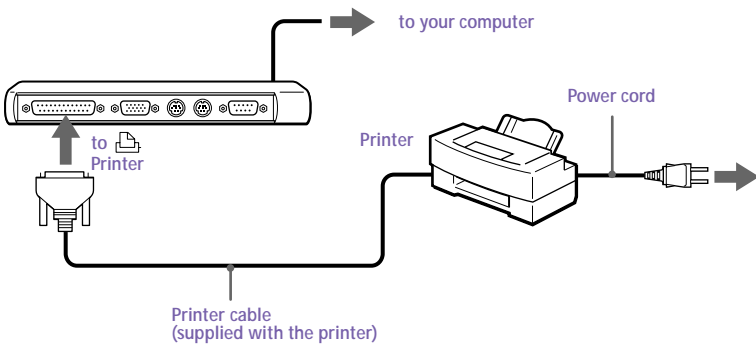

 See the manual that came with your printer for more information on installation and use.

Before using the printer, you may need to change the Printer setting in the Sony Notebook Setup software. See "Displaying the Sony Notebook Setup Screen" on page 51.

Connecting an External Display

You can use the port replicator to connect an external display to your notebook computer. For example, you can use the computer with any of the following:

- ❑ Computer display (monitor) (page 38)
- ❑ Projector (page 39)

To connect a computer display

- ❑ Use the  symbol on the port replicator to locate the Monitor connector. Plug the display cable into this connector.
- ❑ If necessary, plug one end of the display power cord into the display, and the other end into an AC outlet.

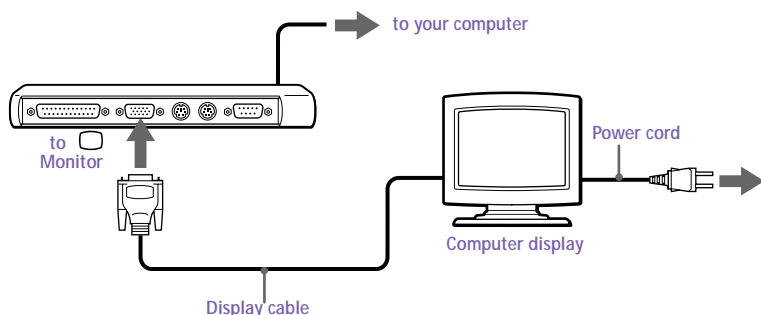

 See the manual that came with your computer display for more information on installation and use.

To connect a projector

You can use a projector as an external display, such as the Sony LCD Projector.

- 1 Use the □ symbol to locate the Monitor connector. Plug the RGB signal cable into this connector.
- 2 Use the ♫ symbol to locate the Headphone connector. Plug the audio cable into this connector.

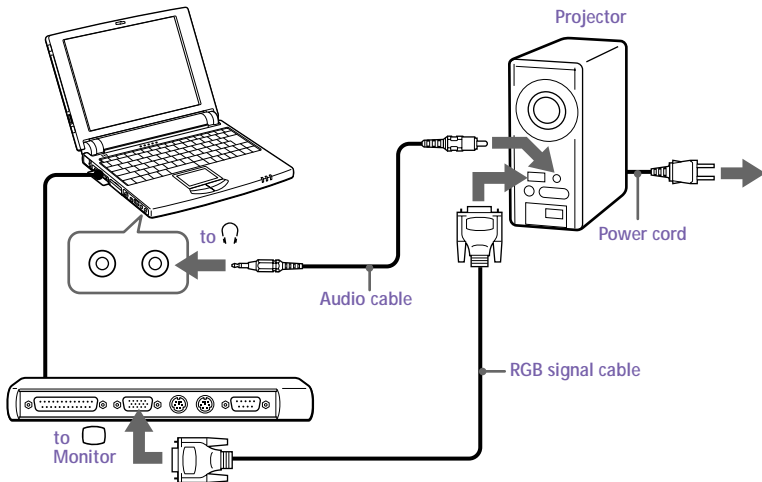

 See the manual that came with your projector for more information on installation and use.



To select a display

When you connect an external display to the monitor connector, you can press **Fn+F7** to toggle the output between the Liquid Crystal Display (LCD), the external monitor, or both devices. See “Selecting the Display Mode” on page 61 for more information.

Connecting an External Mouse and Keyboard

You can use the port replicator to connect an external mouse and keyboard to your computer. The Mouse and Keyboard connectors require a PS/2®-style plug or adapter.

To connect an external mouse and keyboard

- 1 Turn off the computer.
- 2 Use the  and  symbols to locate the Mouse and Keyboard connectors. Plug the mouse cable and keyboard cable into these connectors with the  mark facing up.

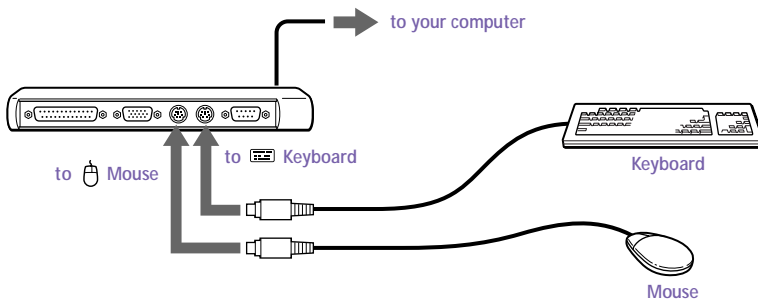

 See "Using the Keyboard" on page 16 for more information on using the keyboard.

See the manual that came with your mouse or keyboard for more information on installation and use.

Before you connect or disconnect the mouse or keyboard, turn off the computer.

Before connecting a mouse to the Serial port, make sure the mouse is compatible with a Serial port.

You cannot use the built-in touchpad and an external mouse at the same time.

Connecting a Desktop Computer or Serial Device

You can use the port replicator to connect your notebook computer to another computer, or to connect other peripherals, such as the Sony Digital Still Camera.

To connect a desktop computer

- Use the  symbol to locate the Serial connector. Plug the connecting cable into this port on the port replicator and into the serial port on the desktop computer.

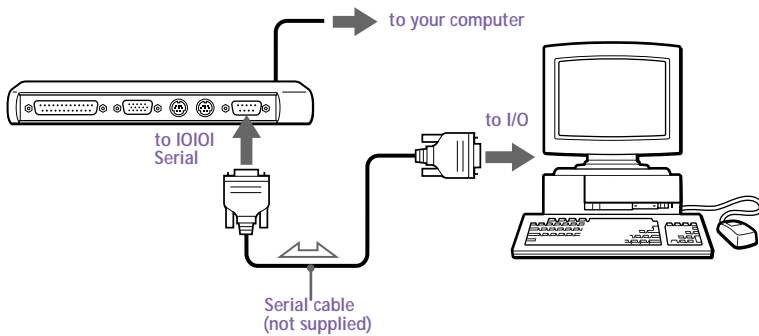

To connect a digital still camera

- Use the IOIOI symbol to locate the Serial connector. Plug the connecting cable into this port on the port replicator and into the Digital I/O connector on the digital still camera.

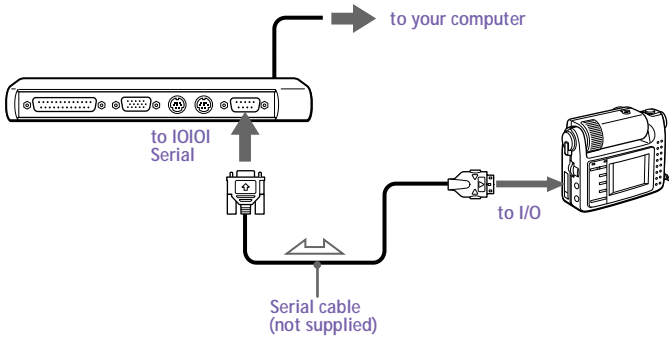

 The Sony Digital Still Camera (DSC-F1) is pictured; you may need to connect your camera differently.

See the manual that came with your digital camera or other serial device for more information on installation and use.

If you use a digital camera that has an infrared data communication system or other infrared communication device, see "Using Infrared Communication Devices" on page 29.

Connecting the CD-ROM Drive

You can use the optional PCGA-CD5 CD-ROM drive with your notebook computer.

To connect the CD-ROM drive

- 1 Turn off your computer.
- 2 Remove the PC card slot protector from the PC card slot. See “Using PC Cards” on page 26 for details.
- 3 Connect the CD-ROM drive cable to the PC card supplied with the CD-ROM drive.

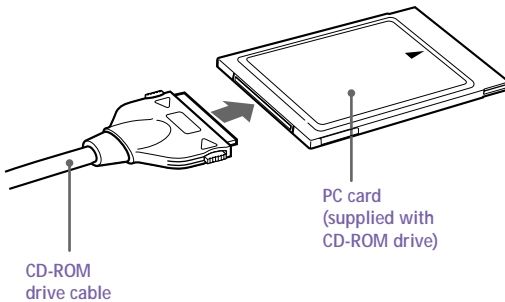

- 4 Insert the PC card into the PC card slot with the label side facing up. See “Using PC Cards” on page 26 for details.

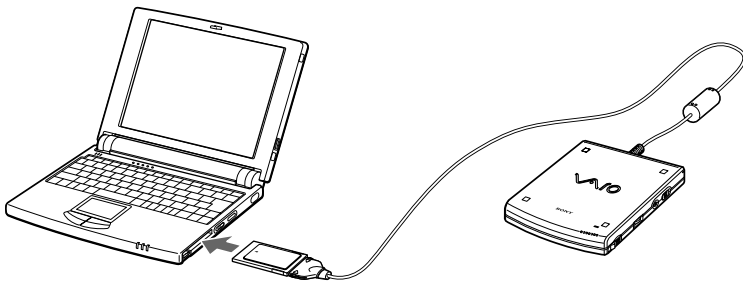

- 5 Connect the CD-ROM drive AC power adapter to the CD-ROM drive and plug the AC adapter into an AC outlet.

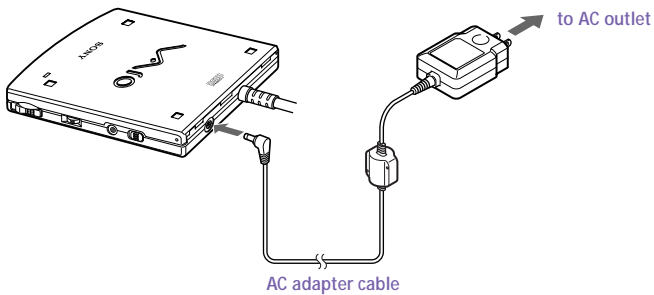

 The pick-up cover is attached to the lens of the CD-ROM drive at the factory. Before using the CD-ROM drive, remove the pick-up cover.

To insert a CD-ROM disc

- 1 Slide the power switch to the on position.
- 2 Slide the Open button in the direction of the arrow to open the CD-ROM drive lid.

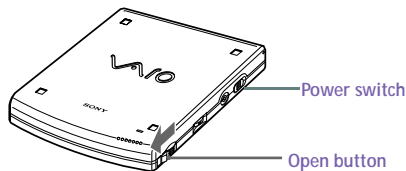

- 3 Place the CD-ROM disc in the tray with the label side facing up. Push the disc onto the hub until the disc clicks into place.

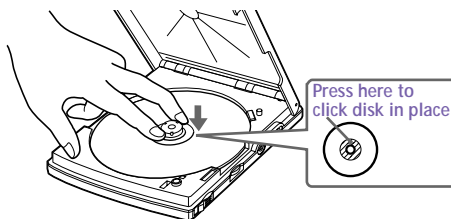

 Be sure to seat the CD-ROM disc firmly over the CD-ROM drive hub fingers. If you do not seat the disc firmly, you could damage your CD-ROM drive and you may not be able to open the CD-ROM drive lid.

- 4 Gently press on the CD-ROM drive lid until it clicks shut.

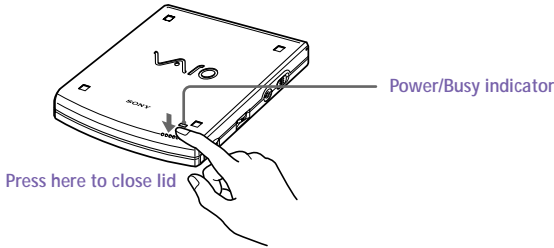

To play an audio CD in the CD-ROM drive

In addition to connecting the CD-ROM drive to your computer, you must connect the drive to the computer with a male-to-male stereo mini plug (not supplied).

- 1 Connect one end of the stereo mini plug to the headphone jack on the CD-ROM drive and the other end to the Line In jack on the left side of your computer.

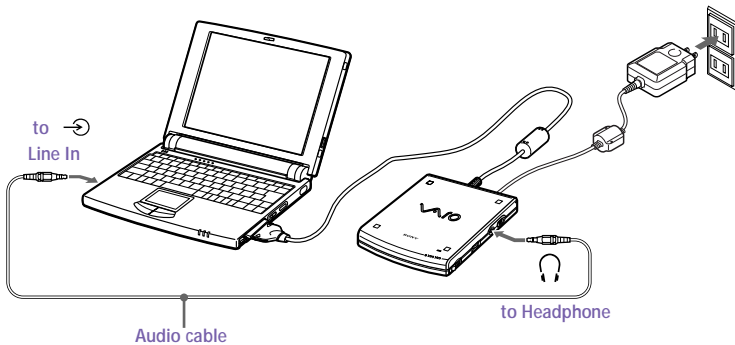

- 2 Right-click the speaker icon on the taskbar and select Open Volume Control from the shortcut menu. The Volume Control window opens.
- 3 Drag the Line In slider to adjust the volume.

To remove the CD-ROM drive

- ❑ Remove the PC card from the computer. See “Using PC Cards” on page 26 for details.

Connecting External Speakers

You can use the optional PCGA-SP51 stereo speakers with your computer or other speakers designed for computer use.

 Turn down the volume of the speakers before you connect them.

To adjust the speaker volume, press Fn+F4. See "Combinations and Functions with the Fn Key" on page 20 for details.

Do not place diskettes on the speakers; the speaker's magnetic field may damage the data on the diskettes.

The internal speaker does not work when the external speakers are connected.

To connect the PCGA-SP51 stereo speakers

- Insert the speakers into the slots on the sides of the display.

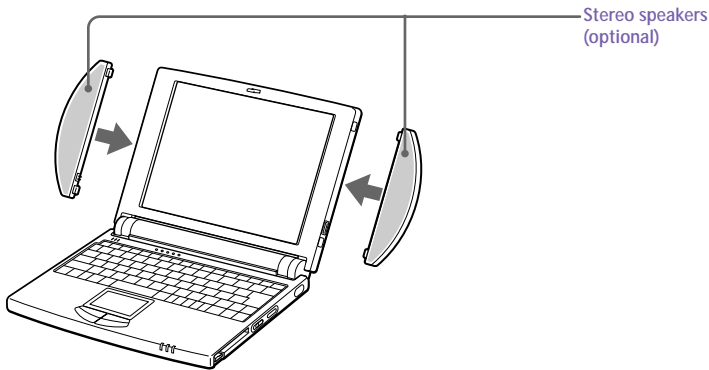

To connect other external speakers

- Use the  symbol to locate the Headphone connector. Plug the speaker cable into this connector.

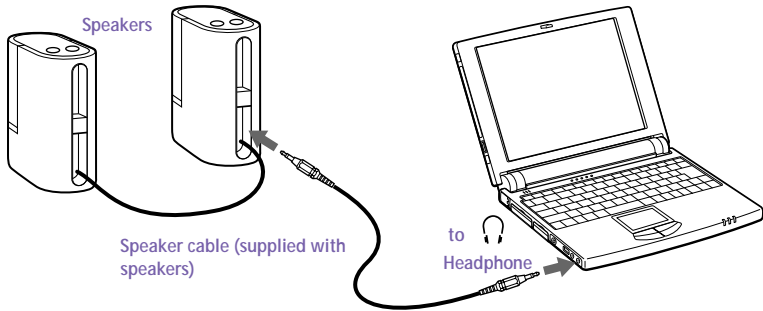

See the manual that came with your speakers for more information on installation and use.

Connecting a Digital Video Camera Recorder

The PCG-505TS and PCG-505TX SuperSlim Notebooks include an i.LINK™ (IEEE1394) connector, which you can use to connect to a digital video camera recorder.

To connect a digital video camera recorder

- ❑ Plug one end of an i.LINK cable into the 200  connector on the left side of the computer and the other end into the DV In/Out connector on the digital video camera recorder.

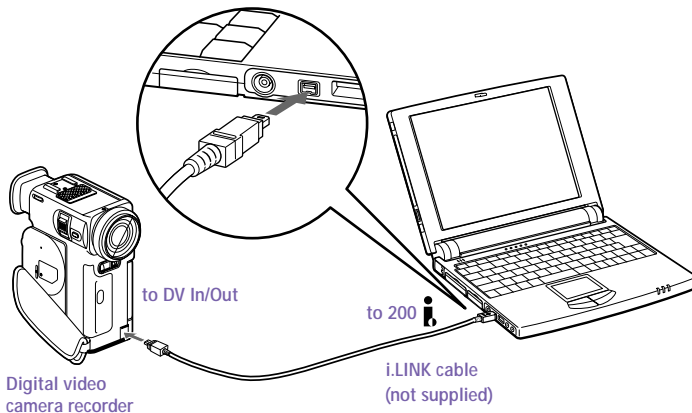

The Sony digital video camera recorder (DCR-PC7) is pictured; your digital video camera recorder may need to be connected differently.

On Sony digital video cameras, connectors labeled "DV In/Out" or "i.LINK" are i.LINK-compatible.

See the manual that came with your digital video camera recorder for more information on installation and use.

The i.LINK connector does not supply power to external devices. If the external device requires power from the i.LINK connector, you cannot use the device with your computer.

The VAIO 505 SuperSlim Notebook supports transfer rates up to 200 Mbps; however, the actual transfer rate is the lowest transfer rate of the external device.

The i.LINK features available may vary depending on the software applications you use. See the documentation that came with your software for more information.

Connecting a Universal Serial Bus (USB) Device

You can connect a USB device to your computer.

To connect a USB device

- Use the  symbol to locate the USB connector on the left side of the computer. Plug one end of a USB cable into this port and the other end into the USB device.

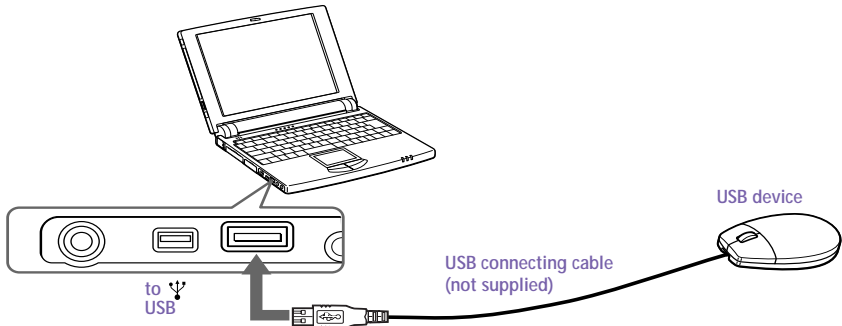

 See the manual that came with your USB device for more information on installation and use.

When you enable the PowerPanel setting that allows the computer to enter System Suspend mode or System Hibernation mode, your computer may enter System Suspend mode or System Hibernation mode while you are using a USB device, such as a USB mouse or a USB keyboard. Therefore, when using a USB device, select the AC Profile or change the profile setting in PowerPanel so that the computer does not enter System Suspend mode or System Hibernation mode. The default AC Profile settings do not allow the computer to enter System Suspend mode or System Hibernation mode. For details, see the PowerPanel Help.

Customizing Your Notebook Computer

You can customize the settings of your notebook computer. The following sections briefly describe how to change your computer's default settings. You can also refer to the Sony Notebook Setup Help for more detailed information.

Displaying the Sony Notebook Setup Screen

To display the Sony Notebook Setup screen:

- 1 Click the Start button on the Windows 98 taskbar.
- 2 Point to VAIO and click Sony Notebook Setup.

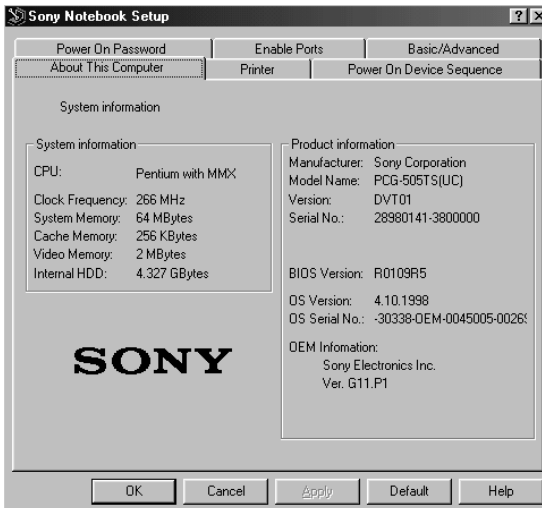

- 3 Select the tab for the item you want to change. See “Notebook Setup Tabs” on page 52.
- 4 After you finish, click OK.

Notebook Setup Tabs

<i>Tab</i>	<i>Descriptions</i>
About This Computer	Display system information, including memory capacity, serial number, and BIOS version.
Printer	Change printer port mode settings.
Power On Device Sequence	Select the order of drives and devices from which you want to load the operating system.
Power On Password	Set the password to secure your computer.
Enable Ports	Change the hardware resources such as I/O address, IRQ, or DMA depending on the optional hardware or software you use. Disabling ports releases resources to the system. To change the serial, audio, and modem settings, click Advanced on the Basic/Advanced tab.
Basic/Advanced	Toggle between Advanced mode (additional screens with advanced settings) and Basic mode of display. Advanced mode includes Serial, Audio, Built-in Modem, Infrared, and View Resources tabs.









For more information about each option, click Help on the Sony Notebook Setup screen to display the help file.

Controlling Power Management

The PowerPanel utility allows you to control the power management of your notebook computer and provides key information about system activity and battery life. The following sections briefly describe how to conserve your computer's battery power. You can also refer to the PowerPanel Help for more detailed information. To activate a profile or command, see "To activate the PowerPanel Profiles toolbar" on page 55.

Power Management Profiles

PowerPanel provides several predefined power management profiles. Each profile consists of a group of specific power management settings that are designed to meet specific power management goals—ranging from maximum power management to no power management. You can change the settings for any of the predefined profiles or you can create your own profile to suit your portable computing needs. The predefined profiles are:

<i>Icon</i>	<i>Description</i>
	Maximum Performance – Provides the best system performance while still conserving power.
	Maximum Battery Life – Provides power saving features to give you maximum battery life and good performance. It slows the computer and puts it into System Suspend mode after a specified period of inactivity.
	Power Management Off – Turns off all power management features such as System Suspend and System Hibernation modes.
	AC Profile – The power management state when AC power is in use. Similar to the Power Management Off setting, PowerPanel automatically loads the AC profile unless you disable this feature.
	Games – Disables the display and the Hard Disk Spindle Down timer.
	Presentation – Keeps the display on at all times while it conserves power. This option is ideal for slide show presentations. You can establish settings for LCD (Video) Standby, Hard Disk Sleep, and System Suspend to optimize power management for your system.



Word Processing – Optimizes power management with longer timeouts on the hard disk and display screen. You can also establish settings for LCD (Video) Standby, Hard Disk Sleep, and System Suspend to optimize power management for your system.



Communications – Extends battery life by initiating a quick display timeout. The Internal modem remains powered. You can also establish settings for LCD (Video) Standby, Hard Disk Sleep, and System Suspend to optimize power management for your system.

Power Management Commands

PowerPanel also provides power management commands that you can use to activate specific power management functions and to control power for a specific device. You might use these commands when you want to override a profile setting or initiate an immediate action, such as putting the system into Video Standby mode before the Video Standby timer expires.



System Suspend – Puts the system into System Suspend mode, a power management state that saves the state of the system and peripheral devices in memory (RAM). Power consumption reduces to a minimum, and the system remains on. To return the system to the active state, press any key or the power switch on your computer.



System Hibernation – Provides for the lowest level of power consumption. The system writes the state of the system and peripheral devices to the hard disk and turns off the system power. To return the system to the original state, use the power switch to turn on power. The system saves the data in the Save to Disk Partition on the hard drive.



LCD (Video) Standby – Turns off the LCD to save power. If you turn off the Video Standby timer, the display remains active except when the system enters System Suspend mode. The video display system is one of the largest consumers of power in the system.



Hard Disk Sleep – Turns off the hard disk spindle motor. Although you can manually turn off the power to the hard disk through this command, any system request to the hard disk turns on the power to the hard disk.



Speed Controller - Controls the speed at which the CPU performs. Click this button to open the Speed Controller dialog box. When you select the Auto checkbox, the CPU performs at full speed while the system is active and at 25% of full speed during periods of inactivity. Auto is the recommended option. You can also choose to run the CPU at 100%, 75%, 50%, or 25% of full speed regardless of whether the system is active or inactive. Using this command can help conserve battery power.



PC Card – Controls the PC card sockets. Click this button to open the PC Card (PCMCIA) Properties dialog box. You can view the properties for the PC cards.

To activate the PowerPanel Profiles toolbar

- 1 Double-click the  (atom) icon on the taskbar. The Profiles toolbar appears.

 When the Profiles toolbar is already visible on the desktop, double-clicking the atom icon hides the toolbar.

When you move the pointer over the atom icon on the taskbar, a tooltip with the name of the active power management profile appears.



- 2 Click the button you want to set.

The power management settings associated with the profile you select become active.

 To display the Commands toolbar, right-click an empty portion of the toolbar and select Commands from the shortcut menu. Refer to the PowerPanel Help for information on customizing the PowerPanel toolbars.

When you use the battery pack to power your computer, your system selects the Maximum Battery Life power management profile by default. If you select a different power management profile while using battery power, that profile is selected automatically the next time you use the battery pack to power your computer.

To change the power management settings using the PowerPanel Profiles toolbar

You can change power management settings, such as the settings for the System Suspend timer or the speed at which the CPU performs.

- 1 Click the  (atom) icon on the taskbar. The PowerPanel bar appears. (If the bar does not appear, click the Start button, point to VAIO, and select PowerPanel.)
- 2 Right-click the Profiles icon for the item you want to change, then click Open. The Profile Manager starts.
- 3 Double-click the item you want to change. A list of settings appears with a check mark indicating the current setting.
- 4 Click the desired setting.
- 5 Click the File menu, then click Save.
- 6 Click the File menu, then click Close. The Profile Manager closes and the new setting is activated.

Displaying Battery Information

You can display detailed information for the battery in your computer. The following sections briefly describe how to display your computer's general battery information. You can also refer to the BatteryScope Help for more detailed information.

Activating BatteryScope

To activate BatteryScope

- 1 Click the Start button on the Windows 98 taskbar.
- 2 Point to VAIO and click BatteryScope. The battery icon appears on the taskbar.

When you move the pointer over the battery icon on the taskbar, a tooltip appears indicating the total capacity remaining in the battery and the estimated time until the battery fully discharges.

You can also view battery gauges on the shared PowerPanel and BatteryScope toolbar.





Percentage indicator

Displays the percentage of the remaining capacity.

Time indicator

Displays estimated time (hours/minutes) remaining before the battery fully drains, also referred to as the time-to-empty.

Battery Icon Descriptions

Battery icon	Battery status
	Discharging
	Charging
	No battery

Displaying Detailed Battery Information

You can obtain detailed information about the batteries.

- Double-click the battery icon on the toolbar to display the BatteryScope window.

The screen appears displaying the Battery tab, which contains information such as the estimated time-to-empty and the charging time.

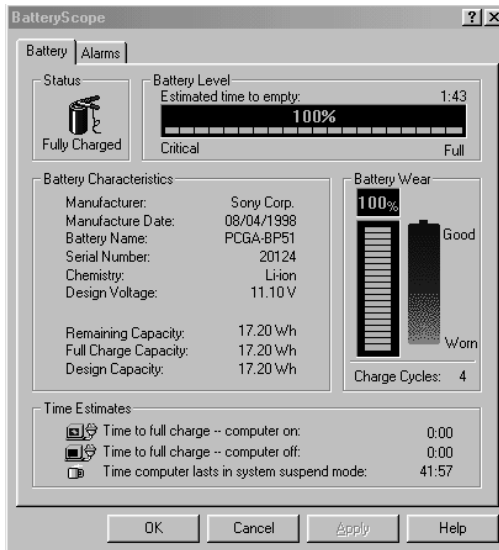

To customize the BatteryScope toolbar and alarm system

You can customize the BatteryScope toolbar to suit your portable computing needs, including modifications to the alarm settings. Refer to the BatteryScope Help for more information.

Starting Your Favorite Software With Programmable Power Key (PPK) Setup

The PPK Setup software enables you to start your favorite software by simply pressing the programmable power key.

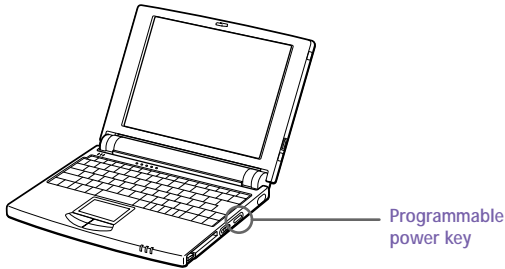

This section briefly describes how to use the programmable power key. You can also refer to the PPK Setup Help for more detailed information.

To use the PPK Setup screen:

- 1 Double-click the PPK Setup icon on the taskbar. The PPK Setup screen appears.

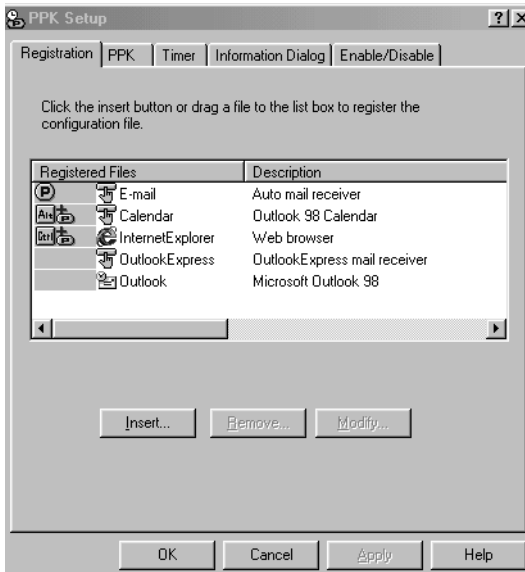

- 2 Select the software title you want PPK to launch automatically from the Registered Files list and right-click. The Setup options screen appears.
- 3 Click Set as PPK launch file. The  appears next to the selected software title.
- 4 Click OK.



The default settings for PPK do not allow you to start the selected software when the computer's LCD is closed. To start the selected software while the LCD is closed, click the Enable/Disable tab and select Enable PPK even if LCD Panel is closed. Be aware, however that the software can now start accidentally if you press the programmable power key when you carry the computer.

Using the Programmable Power Key With Other Keys

You can also choose to start other applications by pressing the programmable power key in combination with the Alt, Ctrl, or Shift keys.

To select the key combination, right-click the application you want to start and select an item from the menu. When you select Set as PPK launch file, you can turn on the power and start the selected application by just pressing the programmable power key. When you select Set as Alt+PPK launch file, Set as Ctrl+PPK launch file, or Set as Shift+PPK launch file, you need to turn on the computer to use these functions.

Using the internal timer:

You can use the internal timer to start software at a specific time. You can use this feature when the computer is on or in system suspend mode.



If the computer's LCD is closed, you cannot use the internal timer to start software using the default settings. To start software while the LCD is closed, click the Enable/Disable tab and select the checkbox next to Enable Timer launch even if LCD Panel is closed.

It may take some time to actually start the software. It is advised that you confirm the time your selected software takes to start.

When selecting software that uses a phone line: The computer may not be able to disconnect the phone line due to communication and server conditions. Be sure to monitor the status of the software when running PPK Setup, and manually disconnect the phone line if you notice a malfunction. Furthermore, when using the timer to start the software, it is advised that you set the computer to enter system suspend or system hibernation mode after a certain time. This allows the computer to disconnect the phone line if the computer fails to disconnect the line normally. However, the computer cannot disconnect the phone line when it enters system suspend mode in case the internal modem ring resume is set to on.

Selecting the Display Mode

When you connect an external display, you can toggle the display mode between the LCD on your computer and an external display.

- 1 Click the Start button on the Windows 98 taskbar.
- 2 Point to Settings and click Control Panel.
- 3 Click Display.
- 4 Click the Settings tab.
- 5 Click the Advanced button.
- 6 Click the NeoMagic® tab.

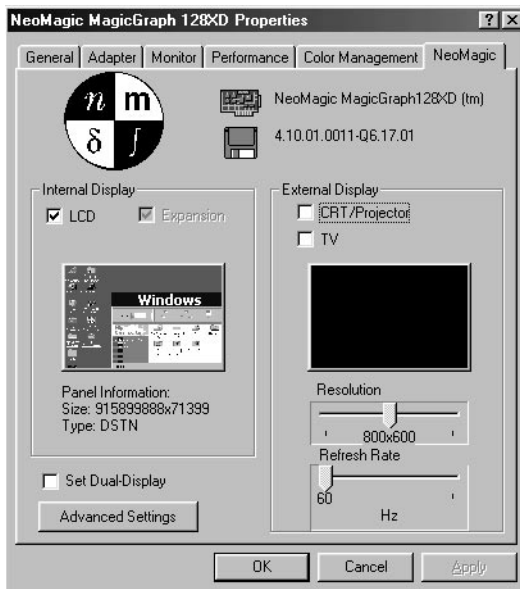

- 7 Click Display Options.
- 8 Select one of the options under Display Mode:

<i>Display modes</i>	<i>Functions</i>
Monitor	Displays only an external display connected to the Monitor connector on the port replicator.
LCD Panel	Displays only the Liquid Crystal Display (LCD) on your computer.
Monitor/LCD	Displays simultaneously both the LCD and an external display connected to the Monitor connector on the port replicator.

9 Click OK until all the Settings windows close.



You can adjust the refresh rate when you select Monitor as the display mode.

Some displays do not support using both the computer's LCD and an external display simultaneously.

To use the Monitor and Monitor/LCD display modes, an external display must be connected to the monitor connector on the port replicator.

Getting Help

Sony provides several support options for your Sony computer. When you have questions about your computer and the preinstalled software, check these sources for answers, in the following sequence:

1	<i>VAIO 505 SuperSlim Notebook Read Me First</i>	Contains a complete list of the items that ship with your computer, product specifications, software support information, and the most up-to-date information on using your computer.
2	<i>VAIO 505 SuperSlim Notebook User Guide</i>	Explains how to use your 505 SuperSlim Notebook and connect peripheral devices.
3	<i>Online User Guide</i>	The electronic version of the <i>User Guide</i> contains additional information on customizing your notebook computer. You can access this guide from the Windows Start menu by selecting Programs/VAIO/Documentation.
4	Manuals and online help files that may accompany your preinstalled software	Most of the manuals for preinstalled software are located on your hard disk drive as online help files. You can access the online help files from the Help menu in the specific application. A printed manual is available for some applications.
5	Knowledge Database	Provides instant access to information on commonly encountered problems. Enter a description of your problem and the Knowledge Database searches for the corresponding solutions online. You can access the Sony Knowledge Database at: http://www.sony.com/pcsupport

-
- 6 **Sony Fax-on-Demand** This service provides you with answers to commonly asked questions. You can use this automated service to request a list of available topics and then select the topics that you want to receive. To contact the Sony fax-on-demand service, call 1-888-4SONYPC (1-888-476-6972). (Requires a fax machine or your fax software.)
-
- 7 **Calling Sony Customer Support** You can call and speak with a Sony Customer Support Representative without using your computer by calling 1-888-4SONYPC (1-888-476-6972). Software support is available free of charge for 90 days after the original date of purchase.
-

Troubleshooting

This section describes how to solve common problems you may encounter when using your computer. Many problems have simple solutions, so try these suggestions before you call Sony Customer Support.



When you reconnect devices, be sure to turn off the computer as described in “Shutting Down Your Computer” on page 13. Turning off the computer using other methods may result in data loss.

My computer does not start

- ❑ Check that the computer is plugged into a power source and that it is turned on. Check that the power indicator on the front panel of the computer indicates that the power is on.
- ❑ Check that the battery is inserted properly and that it is charged.
- ❑ Make sure there is no diskette in the floppy disk drive.
- ❑ Confirm that the AC adapter and all cables are connected firmly, as described in “Connecting Peripheral Devices” on page 33.
- ❑ If you plugged the computer into a power strip or UPS, make sure the power strip or UPS is turned on and working.
- ❑ If you are using an external display, check that it is plugged into a power source and turned on. Check that the brightness control is adjusted correctly. See the manual that came with your display for details.
- ❑ Moisture condensation may have occurred. Do not use the computer for at least one hour and then turn on the computer.
- ❑ When the internal backup battery is low on power, it may not be able to boot your system properly. You can correct this situation as follows: Plug in the AC adapter and allow the computer to charge for one hour while the power is on. Do not use the computer during this time. After one hour, turn the power off and then on again. To charge the internal backup battery fully, keep the AC adapter connected for more than 24 hours after turning the power on. You can use your computer while charging the battery.

When I turn on my computer, the message "Operating system not found" appears and Windows does not start

- ❑ Check the floppy disk drive to see if a non-bootable diskette is in the drive.
- ❑ If a non-bootable diskette is in the drive, turn off the computer, remove the diskette, and then turn on the computer again. Confirm that Windows starts properly. If Windows still does not start, follow the procedure below to initialize the BIOS.
- ❑ If the floppy disk drive is empty or contains a bootable diskette, use the following procedure to initialize the BIOS:
 - 1 Remove the floppy disk drive, port replicator, PC card, and any other peripheral devices. from the computer.
 - 2 Turn the computer off and then turn it on again.
 - 3 Turn on the computer and press the F2 key when the Sony logo appears. The BIOS setup menu screen appears.
 - 4 Press the arrow keys to select the Exit menu.
 - 5 Press the arrow keys to select Get Default Values and then press the Enter key. The message "Load default configuration now?" appears.
 - 6 Check that [Yes] is selected, then press the Enter key.
 - 7 Press the arrow keys to select Exit (Save Changes) and then press the Enter key. The message "Save configuration changes and exit now?" appears.
 - 8 Check that [Yes] is selected, then press the Enter key. The computer restarts.

When I turn on my computer, the message "C:\WINDOWS" appears and Windows does not start

- ❑ Enter "win", then press the Enter key. When the message "MS-DOS is activated. Do you want to return to Windows and restart applications?" appears, press the Enter key again. Windows starts.
- ❑ When shutting down your computer, follow the procedure in "Shutting Down Your Computer" on page 13. Windows should start automatically the next time you turn on your computer.

My LCD does not display anything

- ❑ Check that the computer is plugged into a power source and that it is turned on. Check that the power indicator on the front panel of the computer is on.
- ❑ Check that the battery pack is inserted properly and that it is charged.
- ❑ The computer may be in LCD (Video) Standby mode. Press any key to activate the display.
- ❑ The video output may be directed to an external display attached to the port replicator. Press Fn+F7 until video output appears on the LCD.

The screen image on my external display is not centered or sized properly

Use the controls on your external display to adjust the image. See the manual supplied with your display for more information.

My computer "locks up"

- ❑ Try restarting the computer. On the Windows taskbar, click the Start button, click Shut Down, and then click Restart the computer.
- ❑ If you cannot restart as described in the preceding step, you can restart the computer by pressing Ctrl+Alt+Delete.
- ❑ If the previous step does not work, slide the power switch toward the front and hold it for four seconds. This turns off the power.
- ❑ If your computer locks up while playing a CD-ROM, stop the CD-ROM, and restart the computer by pressing Ctrl+Alt+Delete.



Pressing Ctrl+Alt+Delete or turning off the computer with the power switch may result in data loss in files that are currently open.

My software program "locks up" or crashes

Contact the software publisher or designated provider for technical support.

I cannot print

Try changing the printer port mode. In Sony Notebook Setup, select the Printer/FDD tab. If the printer port mode is set to ECP, change it to bi-directional. If the printer port mode is set to bi-directional, change it to ECP. See "Displaying the Sony Notebook Setup Screen" on page 51 for details on using Sony Notebook Setup.

Movements of the displayed images are awkward (not smooth)

In PowerPanel, select Change CPU Speed. Remove the check from Auto, and set Speed Control to 100%.

I cannot play a CD-ROM

- ❑ Make sure the label of the CD-ROM is facing up.
- ❑ If the CD-ROM requires software, make sure the software is installed according to the program's instructions.
- ❑ Moisture condensation may have occurred. Disconnect the CD-ROM drive and disconnect the power to the drive for at least one hour.
- ❑ Make sure the CD-ROM drive is properly connected. See "Connecting the CD-ROM Drive" on page 43.
- ❑ Clean the CD-ROM.
- ❑ Check the speaker volume.

When I click an application icon a message appears, such as "You must insert the application CD into your CD-ROM drive", and the software does not start

- ❑ Some titles require specific files that are located on the application's CD-ROM. Insert the disc and try starting the program again.
- ❑ Make sure you place the disc in the tray with the label side facing up.

My floppy disk drive cannot write to a diskette

- ❑ The diskette is write-protected. Disable the write-protect feature or use a diskette that is not write-protected.
- ❑ Check that the diskette is properly inserted into the floppy disk drive.

My speaker has no sound

- ❑ The built-in speaker is turned off. Press Fn+F3 to turn on the speaker.
- ❑ The speaker volume is turned to the minimum. Press Fn+F4, and then press ↑ or → to increase the volume.
- ❑ If your computer is powered by the battery, check that the battery is connected properly and that it is charged.
- ❑ If you are using an application that has its own volume control, check that the volume is turned up.
- ❑ Check the volume controls in Windows 98.

- ❑ If you connect external speakers, check that the speakers are properly connected and the volume is turned up. If the speakers have a mute button, make sure it is off. If the speakers are powered by batteries, check that the batteries are inserted properly and that they are charged.
- ❑ If you have connected a headphone or an audio cable to the Headphone connector, disconnect the cable.

When I press Fn+F3, I see the message "Sound Disabled"

Use the following procedure to enable sound:

- 1 Click Start, select Settings, and click Control Panel.
- 2 Double-click the System icon.
- 3 Click the Device Manager tab.
- 4 Double-click Sound, video & game controllers.
- 5 Double-click ES1879 Control Interface (WDM).
- 6 Uncheck the "Disable this hardware profile" box.
- 7 Click Okay. Sound is now enabled.

My modem does not work

- ❑ Check that the phone line is plugged into the line jack. See "Connecting a Phone Line" on page 34 for details.
- ❑ Check that the phone line is working. You can check the line by plugging in an ordinary phone and listening for a dial tone.
- ❑ Check that the phone number the program is dialing is correct.
- ❑ Check that the software you are using is compatible with the notebook computer modem. (All preinstalled programs are compatible.) Call the software publisher or Sony Customer Support.

My modem connection is slow

The computer's modem uses K56flex™ technology/V.90. Many factors influence modem connection speed, including telephone line noise or compatibility with telephone equipment (such as fax machines or other modems). If you think your modem is not connecting properly to other PC-based modems, fax machines, or your Internet Service Provider, check the following:

- ❑ Have your phone company check that your phone line is free from any line noise.

- ❑ If your problem is fax-related, check that there are no problems with the fax machine you are calling and that it is compatible with fax modems.
- ❑ If you are having a problem connecting with your Internet Service Provider, check that the ISP is not experiencing technical problems.
- ❑ If you have a second phone line available, try connecting the modem to that line.

My mouse does not work

- ❑ If you are using an external mouse, check that the mouse is plugged into the mouse connector. See “Connecting an External Mouse and Keyboard” on page 40 for details.
- ❑ If you have connected an external mouse while your computer is on, you should restart your computer.

I cannot use DV devices and messages appear on the screen

- ❑ Check that the DV device is turned on and that the cables are properly connected.
- ❑ If you are using multiple i.LINK devices, the combination of the connected devices may cause unstable operation. In this case, turn off the power to all connected devices and disconnect unused devices. Check the connection, then turn on the power again.

My computer does not shut down

It is best to shut down your computer using the Shut Down command on the Windows 98 Start menu. Using other methods, including those listed here, may result in loss of unsaved data. If the Shut Down command does not work properly, follow these steps:

- ❑ Restart the computer by pressing Ctrl+Alt+Delete. If this does not work, slide the power switch forward and hold it for four seconds.
- ❑ Unplug the computer from the AC adapter and remove the battery pack from your computer.

My PC card is not working

- ❑ Make sure the PC card is compatible with Windows 98.
- ❑ Use the Sony Notebook Setup utility to disable devices you are not currently using.

Using the System and Application Recovery CDs

The following sections describe how to use the System Recovery and Application Recovery utilities. You need to connect the optional PCGA-CD5 CD-ROM drive to use the System and Application Recovery CDs.

Using the System Recovery CD(s)

You can reinstall software titles that shipped with your computer if they are corrupted or accidentally erased. You may not need to recover the entire contents of your hard drive. If you experience a problem with your computer, reinstalling an individual device driver or software title may correct the problem. Use the Application Recovery CDs to reinstall individual applications or device drivers. See “Using the Application Recovery CD(s)” on page 73.

The System Recovery CD contains a backup copy of all the software originally installed on your hard disk drive. **It can be used only to recover the hard disk of the notebook computer you purchased.**

The System Recovery utility gives you three options:

- ❑ **Full Restore without Format** restores all the software titles that originally came with your computer without formatting the hard disk.
- ❑ **Full Restore with Format** formats the hard disk drive and then restores all the original software.
- ❑ **Operating System Only** restores the Windows 98 operating system, the notebook computer utility programs, and the device drivers that shipped with your computer.

! If you choose the Full Restore with Format or Operating System Only option, your hard disk will be formatted, which removes all the information on the hard disk drive. You will lose any software you have installed and any other files you have created since you started to use your computer. This means you will have to reinstall any applications that were not included with the computer when you purchased it. If you choose the Full Restore without Format option, you may need to reinstall applications that were not included with the computer when you purchased it. If you have any questions on using the System Recovery CD, contact Sony Customer Support.

To use the System Recovery CD(s)



The optional PCGA-CD5 CD-ROM drive must be connected to the computer to use the System Recovery CD.

You need to complete the Windows[®] 98 registration process when you use the System Recovery CD. Make sure you have the product ID number located on the cover of your Microsoft Windows 98 "Getting Started" manual. You will need this number to complete the recovery process.

- 1 **Insert the Sony System Recovery CD in the CD-ROM drive.**
- 2 **Shut down your computer as described in "Shutting Down Your Computer" on page 13.**
- 3 **Wait four seconds and turn on your computer.**
- 4 **Click OK to signify you have read and accept the Microsoft End-User License Agreement.**
- 5 **When the System Recovery menu appears, follow the on-screen instructions to complete the recovery process.**



Your system may include one or two System Recovery CDs. If you have two System Recovery CDs, insert the first CD to run the System Recovery program. You are prompted to insert the second CD once the information from the first CD has been installed.

The recovery process takes from 30 to 60 minutes to complete.

If your computer does not start from the Recovery CD

- 1 **Slide the power switch forward and hold it for more than four seconds to turn off the computer.**
- 2 **Turn on the computer and press the F2 key when the Sony logo appears. The BIOS setup menu screen appears.**
- 3 **Press the arrow keys to select the Exit menu.**
- 4 **Press the arrow keys to select Get Default Values and then press the Enter key. The message "Load default configuration now?" appears.**
- 5 **Check that [Yes] is selected, then press the Enter key.**
- 6 **Press the arrow keys to select Exit (Save Changes) and then press the Enter key. The message "Save configuration changes and exit now?" appears.**

- 7 Check that [Yes] is selected, then press the Enter key. The computer restarts from the Recovery CD.

Using the Application Recovery CD(s)

The Application Recovery CDs allow you to reinstall individual applications and device drivers if they are corrupted or accidentally erased. Reinstalling an individual device driver or software title may correct a problem you are experiencing with your computer, and you may not need to recover the entire contents of your hard drive. If you do need to reinstall all the software titles that shipped with your computer, use the System Recovery CD. See “Using the System Recovery CD(s)” on page 71.



You must be in Windows to run the Application Recovery CDs. The application will not run from DOS. If you have any questions on using the Application Recovery CDs, contact Sony Customer Support.

Some applications on the Application Recovery CDs must be decompressed before the installation process begins. Your screen does not change while the files are decompressed. The time to decompress an application varies and may be as long as 30 minutes.

To use the Application Recovery CD(s)

- 1 Turn on your computer. If your computer is already on, close all applications.
- 2 When the Windows desktop appears, insert the first Sony Application Recovery CD in the CD-ROM drive. The Application Recovery utility loads automatically.
- 3 When the Application Recovery menu appears, follow the on-screen instructions to complete the recovery process.

Your system may include one or two Application Recovery CDs. If you have two Application Recovery CDs, insert the first CD to run the Application Recovery program. You may be prompted to insert the second CD, depending on the application you wish to restore.

For a list of the contents of the Application Recovery CD, see the online version of Read Me First.

Notes on Use

This section describes safety guidelines and precautions to help protect your computer from potential damage.

On Handling the LCD Screen

- ❑ Do not leave the LCD facing the sun as it can damage the LCD. Be careful when using the computer near a window.
- ❑ Do not scratch the LCD or exert pressure on it. This could cause malfunction.
- ❑ Using the computer in low temperature conditions may produce a residual image on the screen. This is not a malfunction. When the computer returns to normal temperature, the screen returns to normal.
- ❑ A residual image may appear on the screen if the same image is displayed for a lengthy period of time. The residual image disappears in a while. You can use a screen saver to prevent residual images.
- ❑ The screen becomes warm during operation. This is normal and does not indicate a malfunction.
- ❑ The LCD is manufactured using high-precision technology. You may, however, see tiny black points and/or bright points (red, blue, or green) that continuously appear on the LCD. This is a normal result of the manufacturing process and does not indicate a malfunction.

On the Power Source

- ❑ Your computer operates on 100V-240V AC 50/60 Hz.
- ❑ Do not share the AC outlet with other power-consuming equipment, such as a copying machine or shredder.
- ❑ You can purchase a power strip with a surge protector. This device prevents damage to your computer caused by sudden power surges such as those that may occur during an electrical storm.
- ❑ Do not place heavy objects on the AC adapter or its cord.

- ❑ To disconnect the cord, pull it out by the plug. Never pull the cord itself.
- ❑ Unplug your computer from the wall outlet if you will not be using the computer for a long time.
- ❑ When the AC adapter is not used, unplug it from the AC outlet.
- ❑ Use only the AC adapter supplied. Do not use any other AC adapter.

On Handling

- ❑ Clean the cabinet with a soft, dry cloth or a soft cloth lightly moistened with a mild detergent solution. Do not use any type of abrasive pad, scouring powder, or solvent such as alcohol or benzine, as these may damage the finish of your computer.
- ❑ Should any solid object or liquid fall into the computer, shut down your computer and then unplug it. You may want to have the computer checked by qualified personnel before operating it any further.
- ❑ Do not drop the computer or place heavy objects on top of the computer.

On Installation

- ❑ Do not place your computer in a location subject to:
 - ❑ Heat sources, such as radiators or air ducts
 - ❑ Direct sunlight
 - ❑ Excessive dust
 - ❑ Moisture or rain
 - ❑ Mechanical vibration or shock
 - ❑ Strong magnets or speakers that are not magnetically shielded
 - ❑ Ambient temperature of more than 95° F (35° C) or less than 50° F (10° C)
 - ❑ High humidity
- ❑ Do not place electronic equipment near your computer. The computer's electromagnetic field may cause a malfunction.
- ❑ Provide adequate air circulation to prevent internal heat build-up. Do not place your computer on porous surfaces such as rugs or blankets, or near materials such as curtains or draperies that may block its ventilation slots. Leave a space of at least 8 inches behind the back panel of the computer.

- ❑ The computer uses high-frequency radio signals and may cause interference to radio or TV reception. Should this occur, relocate the computer a suitable distance away from the set.
- ❑ Use only specified peripheral equipment and interface cables; otherwise, problems may result.
- ❑ Do not use cut or damaged connection cables.
- ❑ Your computer will not work with party lines, cannot be connected to a coin-operated telephone, and may not work with multiple phone lines or a private branch exchange (PBX).
- ❑ If the telephone company makes a service call to your home or office and determines that your computer is responsible for a problem, the telephone company may bill you for the service call. Also, if you do not disconnect your computer when it is adversely affecting the telephone line, the telephone company has the right to disconnect your service until you correct the problem.

On Moisture Condensation

If the computer is brought directly from a cold location to a warm one, moisture may condense inside your computer. In this case, allow at least an hour before turning on your computer. If any problems occur, unplug your computer, and contact your Sony Service Center.

On Upgrading the System

- ❑ Memory upgrades must be installed by an authorized Sony Service Center. If you attempt to install a memory upgrade, this will void your warranty.

On Handling Diskettes

- ❑ Do not open the shutter manually and touch the surface of the diskette.
- ❑ Keep diskettes away from magnets.
- ❑ Keep diskettes away from direct sunlight and other heat sources.

On Handling CD-ROM Discs

- ❑ Do not touch the surface of the disc.
- ❑ Do not drop or bend the disc.

On Cleaning CD-ROM Discs

- ❑ Fingerprints and dust on the surface of a disc may cause read errors. Proper care of the disc is essential to maintain its reliability. Do not use solvents such as benzine, thinner, commercially available cleaners or anti-static spray, as they may cause damage to the disc.
- ❑ For normal cleaning, hold the disc by its edge and use a soft cloth to wipe the surface from the center out.
- ❑ If the disc is badly soiled, moisten a soft cloth with water, wring it out well, and use it to wipe the surface of the disc from the center out. Wipe off any remaining moisture with a dry soft cloth.

On Using Batteries

- ❑ Never leave the battery pack in temperatures above 140° F (60° C), such as in a car parked in the sun or under direct sunlight.
- ❑ Battery life is shorter in a cold environment. This is due to decreased battery efficiency at low temperatures.
- ❑ Charge the batteries at temperatures between 50° F and 80° F (10° C to 30° C). Lower temperatures require a longer charging time.
- ❑ While the battery is in use or being discharged, the battery pack heats up. This is normal and is not cause for concern.
- ❑ Keep the battery pack away from all sources of heat.
- ❑ Keep the battery pack dry.
- ❑ Do not open or try to disassemble the battery pack.
- ❑ Do not expose the battery pack to any mechanical shock.
- ❑ If you are not using the computer for an extended period of time, remove the battery pack from the computer to prevent damage to the battery.
- ❑ If, after fully charging the battery pack, the battery power is still low, the battery pack may be reaching the end of its life and should be replaced.
- ❑ You do not need to discharge the battery before recharging.
- ❑ If you have not used the battery pack for a considerable amount of time, recharge the battery.

On Maintenance

- ❑ Make sure to disconnect the AC adapter before cleaning the computer.
- ❑ Avoid rubbing the LCD screen as this can damage the screen. Use a soft, dry cloth to wipe the LCD screen.
- ❑ Clean the computer with a soft cloth lightly moistened with a mild detergent solution. Do not use any type of abrasive pad, scouring powder or solvent, such as alcohol or benzine.

Limited Warranty Statement

VAIO 505 SuperSlim Notebook Computer Warranty

The limited warranty on your Sony 505 SuperSlim Notebook covers parts and labor against defects in material or workmanship for a period of three months from the original date of purchase. You can extend the warranty period for an additional nine months by registering your computer. See “Registering Your Computer” on page 15. Once you register your computer, the limited warranty period is twelve months from the original date of purchase.

There is a separate warranty for the battery included with your computer. See “Battery Limited Warranty” on page 85.

For the purpose of this Limited Warranty “SONY” means SONY ELECTRONICS INC. for Products purchased in the United States of America and Sony of Canada Ltd. for Products purchased in Canada. SONY warrants this computer hardware product (“the Product”) against defects in material or workmanship as follows:

1. Labor: For a period of ninety (90) calendar days from the original date of purchase from SONY or a SONY authorized reseller, SONY will repair defects in material or workmanship in the Product at no charge, or pay the associated labor charges to a SONY authorized personal computer service facility. The ninety (90) day warranty period is extendible only to the original purchaser, for an additional period of nine (9) months, for a total of twelve (12) months from date of purchase when the Product is registered electronically prior to the expiry of ninety (90) days from the original date of purchase. After the applicable period you must pay for all labor charges.

2. Parts: For a period of ninety (90) calendar days from the original date of purchase from SONY or a SONY authorized reseller, SONY will supply, at no charge, new or rebuilt, at SONY’s option, replacement parts in exchange for defective parts. Any replacement parts will be warranted for the remainder of the original warranty period or ninety (90) calendar days from installation by SONY’s authorized personal computer service facility, whichever is longer. The ninety (90) day warranty period is extendible only to the original purchaser, for an additional period of nine (9) months, for a total of twelve (12) months from date of purchase when the Product is registered electronically prior to the expiry of ninety (90) days from the original date of purchase. All defective parts replaced under this Limited Warranty will become the property of SONY.

This Limited Warranty covers only the hardware components packaged with the Product. It does not cover technical assistance for hardware or software usage and it does not cover any software products whether or not contained in the Product; SONY excludes all warranties express or implied in respect of any software provided with the product and any such software is provided “AS IS” unless expressly provided for in any enclosed software limited warranty. Please refer to the End User License Agreements included with the Product for your rights and obligations with respect to the software.

This Limited Warranty is non-transferable. Proof of purchase in the form of a bill of sale (which is evidence that the Product is within the warranty period) must be presented to obtain warranty service. In addition, if replacement parts are required and you wish to receive the most expedient service available, you will be required to provide SONY with a credit card authorization to bill your credit card in the event you fail to return the original parts in the postage-paid envelope we provide. The credit card will only be charged for SONY's list price for the part if the original part has not been returned within thirty (30) days.

In respect of certain components you may be entitled to express warranty service during the warranty period, subject to certain restrictions. Please contact SONY as indicated below for further information.

With respect to all service provided, it is your responsibility prior to Product service to backup the contents of your hard drive, including any data you have stored or software you have installed on the hard drive. It is likely that the contents of your hard drive will be lost or reformatted in the course of service and SONY will not be responsible for any damage to or loss of any programs, data or other information stored on any media or any part of any Product serviced hereunder or any consequential damages resulting therefrom.

IF DURING THE REPAIR OF THE PRODUCT THE CONTENTS OF THE HARD DRIVE ARE ALTERED, DELETED, OR IN ANY WAY MODIFIED, SONY IS NOT RESPONSIBLE WHATSOEVER. YOUR PRODUCT WILL BE RETURNED TO YOU CONFIGURED AS ORIGINALLY PURCHASED (SUBJECT TO AVAILABILITY OF SOFTWARE).

Be sure to remove all third party hardware, software, features, parts, options, alterations, and attachments not warranted by SONY prior to sending the Product to SONY for service. SONY is not liable for any loss or damage to these items.

This Limited Warranty does not cover any consumable items (such as batteries) supplied with this Product; cosmetic damages; damage or loss to any software programs, data, or removable storage media; or damage due to (1) acts of God, accident, misuse, abuse, negligence, commercial use or modifications of this Product; (2) improper operation or maintenance of this Product; (3) connection to improper voltage supply; or (4) attempted repair by any party other than a SONY authorized personal computer service facility. This Limited Warranty does not apply when the malfunction results from the use of this Product in conjunction with accessories, products or ancillary or peripheral equipment, or where it is determined by SONY that there is no fault with this Product itself. This Limited Warranty is valid only in the United States of America and Canada. This Limited Warranty is invalid if the factory applied serial number has been altered or removed from the Product.

Repair or replacement of defective parts or hardware as provided under this Limited Warranty is the exclusive remedy of the consumer. SONY SHALL NOT BE LIABLE FOR ANY INCIDENTAL OR CONSEQUENTIAL DAMAGES OR OTHER DAMAGES INCLUDING BUT NOT LIMITED TO, LOSS OF PROFITS, LOSS OF REVENUE, LOSS OF DATA, LOSS OF USE OF THE PRODUCT OR ANY ASSOCIATED EQUIPMENT, DOWN TIME AND PURCHASER'S TIME. FOR BREACH OF ANY EXPRESS OR IMPLIED WARRANTY, BREACH OF CONTRACT, NEGLIGENCE, STRICT LIABILITY OR ANY OTHER LEGAL THEORY RELATED TO THIS PRODUCT, EXCEPT TO THE EXTENT PROHIBITED BY APPLICABLE LAW, ANY IMPLIED WARRANTY OF MERCHANTABILITY OR FITNESS FOR A PARTICULAR PURPOSE ON THIS PRODUCT IS LIMITED IN DURATION TO THE DURATION OF THIS WARRANTY.

Some states or provinces do not allow the exclusion or limitation of incidental or consequential damages, or allow limitations on how long an implied warranty lasts, so the above limitations or exclusions may not apply to you. This Limited Warranty gives you specific legal rights, and you may have other rights which vary from state to state, or province to province.

Technical Support: Although technical support is not provided free of charge under this Limited Warranty, SONY has established a telephone number for technical support. Charges may apply for technical support, unless and to the extent that free technical support for a limited period is provided in writing as a feature of your Product. Prior to placing your call, please have available the model and serial number for your Product, date of purchase, a list of all options installed in your Product and a detailed description of the problem.

For Product support, online knowledge base, frequently asked questions, and free updates via the Internet: <http://www.sony.com/pcsupport/>

For Product information, service assistance, resolution of a service problem, or technical assistance, call: 1-888-4SONYPC (476 – 6972).

Save this for future reference.

© 1998 Sony Electronics Inc. and Sony of Canada Ltd. Reproduction in whole or in part without written permission is prohibited. All rights reserved. SONY is a registered trademark of Sony.

GARANTIE RESTREINTE

SONY DU CANADA LTÉE (“SONY”) garantit comme suit ce Produit d’ordinateur (“le Produit”) contre tous vices de matières premières et de fabrication :

1. Main-d’oeuvre : Pendant une période de quatre-vingt-dix (90) jours à compter de la date d’achat originale chez SONY ou chez un de ses revendeurs autorisés, SONY réparera le Produit à ses frais ou en remboursera les frais de main-d’oeuvre au centre de réparation d’ordinateur personnel autorisé SONY. La période de garantie de quatre-vingt-dix (90) jours peut être prolongée au bénéfice de l’acheteur original pour une période additionnelle de neuf (9) mois, soit un total de douze (12) mois à compter de la date d’achat, lorsque le Produit est enregistré électroniquement. Après la période applicable, l’acheteur doit payer tous les frais de main-d’oeuvre.
2. Pièces : Pendant une période de quatre-vingt-dix (90) jours à compter de la date d’achat originale chez SONY ou chez un de ses revendeurs autorisés, SONY fournira à ses frais des pièces de rechange neuves ou reconstruites, à sa discrétion, en échange des pièces défectueuses. Ces pièces de remplacement seront garanties pour le reste de la période originale de garantie ou pour quatre-vingt-dix (90) jours à compter de leur installation par un centre de service d’ordinateur personnel autorisé SONY, au plus long des deux termes. La période de garantie de quatre-vingt-dix (90) jours peut être prolongée au bénéfice de l’acheteur original pour une période additionnelle de neuf (9) mois, soit un total de douze (12) mois à compter de la date d’achat, lorsque le Produit est enregistré électroniquement. Toutes les pièces défectueuses remplacées au titre de cette garantie restreinte deviennent la propriété de SONY.

Cette garantie restreinte couvre uniquement les composants physiques emballés avec le Produit. Elle n’inclut pas l’assistance technique en rapport avec l’utilisation du matériel ou du logiciel et ne couvre aucun logiciel, qu’il soit ou non fourni avec le Produit. Les logiciels sont fournis “TELS QUELS” à moins d’être expressément couverts par une autre garantie restreinte spécifique. Veuillez vous reporter aux Contrats de licence d’utilisation accompagnant le Produit quant à vos obligations en rapport avec les logiciels.

Cette garantie restreinte est incessible.

Pour vous prévaloir du service au titre de la garantie, vous devrez présenter une preuve d’achat sous forme de facture de vente attestant que le Produit est couvert par la garantie en vigueur. Par ailleurs, si des pièces doivent être remplacées et que vous désirez obtenir le service le plus rapide possible, vous devrez fournir à SONY une autorisation lui permettant d’en porter le montant à votre carte de crédit advenant que vous négligiez de retourner les pièces originales dans l’enveloppe affranchie qui vous est fournie. Seul le prix courant de SONY pour cette pièce sera porté à votre carte de crédit si la pièce ne lui est pas retournée dans un délai de trente (30) jours.

Vous pouvez avoir droit au service de garantie exprès durant la période de garantie, sous réserve de certaines restrictions. Pour tout renseignement, veuillez communiquer avec SONY de la façon indiquée ci-après.

Vous avez l’entière responsabilité de faire une copie de sauvegarde du contenu du disque dur, incluant toute donnée en mémoire ou tout logiciel que vous y avez installé. Il est fort probable que le contenu du disque dur sera reformaté ou perdu en cours de service et SONY ne pourra être tenue responsable d’aucun dommage ni de la perte des programmes, des données ou de toute autre information gardée en mémoire sur tout support d’information ou sur toute partie de tout Produit en réparation.

SI, DURANT LA RÉPARATION DU PRODUIT, LE CONTENU DU DISQUE DUR EST ALTÉRÉ, SUPPRIMÉ OU MODIFIÉ, SONY N’EN SERA AUCUNEMENT RESPONSABLE. LE PRODUIT VOUS SERA RETOURNÉ TEL QU’IL ÉTAIT CONFIGURÉ QUAND VOUS L’AVEZ ACHETÉ (SOUS RÉSERVE DE LA DISPONIBILITÉ DU LOGICIEL).

Avant d'envoyer le Produit à SONY pour le faire réparer, assurez-vous d'en retirer tous produits de tierce partie, logiciels, caractéristiques, pièces, options, altérations et accessoires non garantis par SONY car SONY n'est pas responsable de la perte ou de l'endommagement de ces articles.

Cette garantie restreinte exclut les articles consommables (comme les batteries) fournis avec le Produit ; les dommages cosmétiques ; l'endommagement ou la perte des logiciels, données et supports informatiques amovibles ; les dommages dus à 1) un cas fortuit, un accident, une mauvaise utilisation, un abus, une négligence, une utilisation commerciale ou une modification du Produit ; 2) l'utilisation ou l'entretien incorrect du Produit ; 3) le branchement à une source électrique non conforme ; ou 4) toute tentative de réparation par tout autre qu'un centre de service d'ordinateur personnel autorisé SONY. Cette garantie restreinte ne s'applique pas si la défectuosité est causée par l'utilisation du Produit en conjonction avec des accessoires, articles ou équipements périphériques ou connexes, ou si SONY détermine que le Produit lui-même ne comporte aucun défaut. Cette garantie restreinte n'est valide qu'au Canada.

Cette garantie restreinte est nulle si le numéro de série appliqué en usine a été modifié ou enlevé du Produit.

La réparation ou le remplacement du matériel ou des pièces défectueuses tel que prévu au titre de cette garantie est le seul recours de l'acheteur. SONY NE SERA AUCUNEMENT RESPONSABLE DE TOUT DOMMAGE INDIRECT OU CONSÉCUTIF POUR DÉROGATION À TOUTE GARANTIE EXPRESSE OU TACITE, RUPTURE DE CONTRAT, NÉGLIGENCE, RESPONSABILITÉ STRICTE OU TOUTE AUTRE THÉORIE JURIDIQUE EN RAPPORT AVEC CE PRODUIT. DE TELS DOMMAGES INCLUENT, ENTRE AUTRES, LE TEMPS DE L'ACHETEUR, LA PERTE DE PRODUCTIVITÉ, DE REVENUS ET DE PROFITS, ET LA PERTE DE DONNÉES OU D'UTILISATION DU PRODUIT OU DE TOUT ÉQUIPEMENT CONNEXE. SAUF DANS LA LIMITE OÙ LA LOI APPLICABLE L'INTERDIT, TOUTE GARANTIE TACITE DE VALEUR MARCHANDE OU DE CONVENANCE À UNE FIN PARTICULIÈRE DE CE PRODUIT EST RESTREINTE DANS SA DURÉE À LA DURÉE DE CETTE GARANTIE.

Certaines provinces ne permettent pas l'exclusion ou la restriction des dommages accidentels ou indirects et n'admettent pas de limites quant à la durée d'une garantie tacite, de sorte que les exclusions/restrictions exprimées ci-dessus peuvent ne pas s'appliquer. Cette garantie vous donne des droits spécifiques et vous pouvez en avoir d'autres qui varient selon la province.

Soutien technique : Bien que le soutien technique ne soit pas offert gratuitement au titre de cette garantie restreinte, SONY a prévu une ligne téléphonique à cet effet. Des frais peuvent être exigés à moins que le soutien technique gratuit et temporaire ne soit expressément indiqué par écrit comme caractéristique de votre Produit. Avant de placer l'appel, assurez-vous d'avoir les numéros de modèle et de série du Produit, la date d'achat, la liste des options qui y sont installées et une description détaillée du problème.

Vous trouverez sur l'Internet un appui direct, une base de renseignements, une foire aux questions et des mises à jour gratuites sous <http://www.sony.com/pcsupport/>

Pour de l'information sur les produits, de l'aide avec le service, la résolution de problèmes de service ou pour une aide technique, veuillez composer le 1-888-4SONYPC (476-6972).

À conserver pour référence future.

©1998 Sony du Canada Ltée. Reproduction partielle ou complète interdite sans autorisation écrite préalable. Tous droits réservés. SONY est une marque déposée de Sony.

Battery Limited Warranty

The limited warranty on the battery included with your Sony VAIO Notebook Computer covers defects in material or workmanship for a period of 30 days from the original date of purchase. This warranty is not extendible.

For the purposes of this Limited Warranty, "SONY" means Sony Electronics Inc. for Products purchased in the United States of America and Sony of Canada Ltd. for Products purchased in Canada. Sony warrants this Product against defects in material or workmanship for thirty (30) days from your purchase date. If this Product is determined to be defective, SONY will replace the Product at no charge to you. This Limited Warranty contains your exclusive remedy. SONY shall not be liable for any incidental or consequential damages for breach of any express or implied warranty on this product. Some states and provinces do not allow the exclusion or limitation of incidental or consequential damages, so the above limitation or exclusion may not apply to you. This warranty gives you specific legal rights which vary from state to state or province to province. For information on obtaining warranty service, please call SONY at 1-888-4SONYPC (1-888-476-6972).

GARANTIE RESTREINTE

Au titre de cette garantie restreinte, "SONY" signifie Sony du Canada Ltée pour les produits achetés au Canada et Sony Electronics Inc. pour les produits achetés aux États-Unis. SONY garantit ce produit contre tous vices de matières premières et de fabrication pour trente (30) jours à compter de la date d'achat. Si ce produit est reconnu défectueux, SONY le remplacera à ses frais. Cette garantie restreinte est votre seul recours. SONY ne sera aucunement responsable de tout dommage indirect ou consécutif pour dérogation à toute garantie tacite ou expresse sur ce produit. Certaines provinces ne permettent pas l'exclusion ou la restriction des dommages accidentels ou indirects, de sorte que les exclusions/restrictions exprimées ci-dessus peuvent ne pas s'appliquer. Cette garantie vous donne des droits spécifiques et vous pouvez en avoir d'autres qui varient selon la province. Pour de l'information sur le service au titre de la garantie, veuillez appeler Sony au 1-888-4SONYPC (1-888-476-6972).

Index

A

- About This Computer tab 52
- AC adapter 8
- AC power 8
- AC Profile power setting 53
- adding
 - hardware 33
 - peripherals 33
 - printers 37
- adjusting
 - brightness 20
- air circulation 76
- Alt key 17
- Application Recovery CDs 73
- Applications key 17
- attaching port replicator 36

B

- Basic/Advanced tab 52
- battery pack 9, 78
 - charge status icons 57
 - charging 10
 - connector 6
 - indicator light status 10
 - indicator lights 5, 10, 19
 - inserting 9
 - loading 9
 - power status 10
 - rechargeable 8
 - removing 11
- battery power 10
- BatteryScope utility 57
- brightness
 - adjusting 12, 20
- built-in speaker 5, 20

- volume 20

- buttons
 - Finish 14
 - left 5
 - Open 44
 - right 5
 - Start (Windows 98) 13, 51

C

- camera 41
- cameras
 - digital video recorder 48
 - Sony Digital Still 41
- canceling commands 17
- Caps Lock 5
 - indicator light 19
- CD-ROM discs
 - cleaning 78
 - handling 77, 78
 - inserting 44
 - playing audio 45
- CD-ROM drive
 - closing lid 45
 - connecting 26, 43
 - opening lid 44
 - troubleshooting 68
 - using 43
- charge status indicator light 10
- charging battery pack 10
- choosing
 - power source 8
- cleaning computer 76
- coin-operated telephones 34
- computer
 - cleaning 76

- condensation 77
 - customizing 51
 - lithium ion battery v
 - setting up 5
 - setup screen 51
 - starting 12
 - troubleshooting 65–70
 - connecting
 - CD-ROM drive 26, 43
 - coin-operated telephones 34
 - digital still camera 41
 - digital video camera recorder 48
 - external keyboard 40
 - external mouse 40
 - external speakers 46, 47
 - floppy disk drive 24
 - keyboard 40
 - monitor 38
 - multiple phone lines 34
 - network 26
 - parallel devices 37
 - party phone lines 34
 - PBX 34
 - phone line 34
 - port replicator 35, 36
 - power source 8
 - printer 37
 - projector 39
 - serial device 41
 - USB device 49
 - connectors
 - battery 6
 - DC In 6, 8
 - external speakers 6
 - FDD 6, 24
 - headphone 6
 - i.LINK 6
 - infrared 7, 29
 - keyboard 35
 - monitor 35
 - mouse 35
 - parallel 37
 - parallel port 35
 - phone line 6
 - port replicator 6
 - printer 35, 37
 - Serial port 35
 - USB 6
 - correction keys 16, 17
 - Ctrl key 17
 - cursor-movement keys 16
 - customer assistance
 - support options 63
 - customizing your computer 51
- D*
- DC In 6, 8
 - digital still camera 29
 - connecting 41
 - digital video camera recorder 48
 - diskettes
 - ejecting 25
 - handling 77
 - inserting into drive 24
 - troubleshooting 68
 - display
 - connector 35
 - mode 61
 - options 39
 - selecting 39
 - disposal of lithium ion battery v
 - drives 43
 - CD-ROM 43
 - floppy disk 6, 24
 - DV In/Out 6, 48
- E*
- Eject button 25
 - ejecting
 - diskettes 25
 - electronic
 - documentation 63
 - Enable Ports tab 52
 - ergonomic considerations 2–3
 - Escape key 17
 - Express Service technical support 15
 - external devices
 - display 3, 38
 - See also monitor
 - keyboard 40
 - mouse 40
 - speakers 46, 47

F

- faxes
 - laws governing iv
- FDD connector 6, 24
- Finish button 14
- floppy disk drive
 - connecting 24
 - connector 6
 - disconnecting 25
 - troubleshooting 68
- Fn key 17
 - combination commands 20
- function keys 16, 17

G

- Games 53
- glare 3

H

- handling
 - audio CDs 78
 - CD-ROM discs 77, 78
 - diskettes 77
- Hard Disk Sleep power setting 54
- hard drive
 - indicator light 5, 19
- headphone
 - connector 6, 39
- help 63

I

- i.LINK 6, 48
- IEEE1394 6, 48
- indicator lights 19
 - battery 5, 10, 19
 - Caps Lock 5, 19
 - charge status 10
 - hard drive 5, 19
 - Information 5, 19
 - modem 5
 - Num Lock 5, 19
 - power 5
 - Scroll Lock 5, 19
- infrared communication devices 29
 - other computers 29

- infrared port 7, 29
- infrared transmission
 - active distance 30
 - troubleshooting 30
- input devices iii
- Insert key 16, 17
- inserting
 - battery pack 9
 - diskettes into drive 24
- installing
 - hardware 33
 - peripherals 33
- interference iii, 77
- internal speaker
 - See speakers

K

- keyboard 5, 16–18, 20
 - connecting 40
 - connector 40
 - external connector 35

L

- LCD 62, 75
 - lock lever 12
 - reducing glare 3
 - selecting to display output 39
 - troubleshooting 67
 - left button 5
 - lever
 - LCD 12
 - lighting 3
 - Limited Warranty 15, 81
 - Liquid Crystal Display screen
 - See LCD
 - lithium ion battery
 - disposal v
 - safety precautions v
 - loading
 - battery pack 9
 - location for computer 3
- M**
- maintenance 76, 79
 - Maximum Battery Life power setting

Maximum Performance power setting
53

microphone 5

modem

connector 6

indicator 5

laws governing iv

troubleshooting 69

moisture condensation 77

monitor 35, 62

connecting 38

connector 39

selecting 39

switching among 20

mouse

connecting 40

connector 35

troubleshooting 70

multiple phone lines 34

N

navigation keys 16

network

connecting 26

Notebook Setup tabs 52

Num Lock 5

indicator light 19

numeric keypad area 16

O

online

help 63

support options 63

Open button 44

opening

CD-ROM drive lid 44

operator keys 17

output devices iii

adding 37

P

parallel port 35, 37

party phone lines 34

PBX 34

PC card

inserting 26

release button 26

removing 28

slot protector 27

slots 7, 26

troubleshooting 70

Type II 26

pen 6

phone

connecting line 34

jack 6, 34

laws governing iv

plastic pen 6, 22

port replicator 6

connecting 35, 36

power 19

indicator light 5

programmable key 7

switch 7, 12

power management

settings 53

Power Management Off power setting

53

Power On

Device Sequence tab 52

Password tab 52

power saving modes 31

System Hibernation 20, 32

System Suspend 20, 31

Video Standby 20

power setting

AC Profile 53

LCD (Video) Standby 54

Maximum Battery Life 53

Maximum Performance 53

Power Management Off 53

System Hibernation 54

System Suspend 54

power sources 8, 75

connecting 8

power standby

Hard Disk Sleep 54

PowerPanel

activating 55

customizing toolbar 53, 54

PPK 7

precautions 76

- Presentation 53
- Print Screen key 17
- printer
 - connecting 37
 - connector 35, 37
 - port 37
- programmable power key 7
- projector 39
- R**
- radio interference iii, 77
- rechargeable battery pack 8, 9
- recharging battery pack 10
- Recovery CDs 73
- registering
 - Windows 98 14
 - your computer 15
- regulatory information iii
- removing
 - battery pack 11
 - diskettes 25
 - floppy disk drive 25
- restoring data 73
- right button 5
- S**
- screen
 - See LCD
- ScribblePad 23
 - plastic pen 6
- Scroll Lock 5
 - indicator light 19
- selecting
 - display 39
 - LCD 39
 - monitor 39
 - power source 8
- Serial connector 35, 41
- serial devices
 - connecting 41
 - digital still 42
- setting up
 - Windows 98 14
- setup screen
 - About This Computer tab 52
 - Basic/Advanced tab 52
 - displaying 51
 - Enable Ports tab 52
 - Power On Device Sequence tab 52
 - Power On Password tab 52
- setup tabs 52
- Shift key 17
- Shut Down Windows dialog box 13
- Sony Customer Support 64
- Sony Fax-on-Demand service 64
- Sony Notebook Setup screen 51
- speakers
 - built-in 5
 - connectors 6
 - external 46, 47
 - troubleshooting 68
- Start button 13, 51
- starting
 - computer 12
- startup problems 13
- switching
 - display 20
 - monitor 20
- System Hibernation mode 20, 32, 54
- System Suspend mode 20, 31, 54
- T**
- technical support
 - support options 63
- touchpad 5, 21
- troubleshooting 65–70
 - startup 13, 65
- turning on
 - computer 12
- TV interference iii, 77
- U**
- USB
 - connecting 49
 - connector 6, 49
- V**
- ventilation 76
- video camera recorder 48
- Video Standby mode 20

W

warranty 15, 81

Windows 98

 Certificate of Authenticity 14

 Control Panel 30

 Explorer 18

 Find window 18

 Finish button 14

 Help 18

 key 17

 key combinations 18

 License Agreement 14

 registering 14

 setup 14

 Setup Wizard screen 14

 Start button 13

 taskbar 13, 67