

SONY®

VAIO® Notebook Computer User Guide

PCG-F150/PCG-F160/PCG-F180/PCG-F190



Notice to Users

© 1999 Sony Electronics Inc. All rights reserved. This manual and the software described herein, in whole or in part, may not be reproduced, translated, or reduced to any machine-readable form without prior written approval.

SONY ELECTRONICS INC. PROVIDES NO WARRANTY WITH REGARD TO THIS MANUAL, THE SOFTWARE, OR OTHER INFORMATION CONTAINED HEREIN AND HEREBY EXPRESSLY DISCLAIMS ANY IMPLIED WARRANTIES OF MERCHANTABILITY OR FITNESS FOR ANY PARTICULAR PURPOSE WITH REGARD TO THIS MANUAL, THE SOFTWARE, OR SUCH OTHER INFORMATION. IN NO EVENT SHALL SONY ELECTRONICS INC. BE LIABLE FOR ANY INCIDENTAL, CONSEQUENTIAL, OR SPECIAL DAMAGES, WHETHER BASED ON TORT, CONTRACT, OR OTHERWISE, ARISING OUT OF OR IN CONNECTION WITH THIS MANUAL, THE SOFTWARE, OR OTHER INFORMATION CONTAINED HEREIN OR THE USE THEREOF.

Sony Electronics Inc. reserves the right to make any modification to this manual or the information contained herein at any time without notice. The software described herein is governed by the terms of a separate user license agreement.

This product contains software owned by Sony and licensed by third parties. Use of such software is subject to the terms and conditions of license agreements enclosed with this product. Some of the software may not be transported or used outside the United States. Software specifications are subject to change without notice and may not necessarily be identical to current retail versions.

Updates and additions to software may require an additional charge. Subscriptions to online service providers may require a

fee and credit card information. Financial services may require prior arrangements with participating financial institutions.

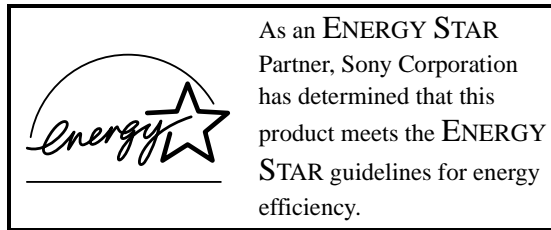

The International ENERGY STAR Office Equipment Program is an international program that promotes energy saving through the use of computers and other office equipment. The program backs the development and dissemination of products with functions that effectively reduce energy consumption. It is an open system in which business proprietors can participate voluntarily. The targeted products are office equipment such as computers, displays, printers, facsimiles and copiers. Their standards and logos are uniform among participating nations. ENERGY STAR is a U.S. registered mark.

Sony, i.LINK, VAIO and the VAIO logo are trademarks of Sony Corporation. Windows, Windows NT, and the Windows 98 logo are registered trademarks of Microsoft Corporation. Intel, MMX, and Pentium are trademarks of Intel Corporation.

All other trademarks are trademarks of their respective owners.

Safety Information

Owner's Record

The model number and serial number are located on the bottom of your Sony VAIO Notebook Computer. Record the serial number in the space provided here. Refer to the model and serial number when you call your Sony Service Center.

Model Number: PCG-F150/PCG-F160/
PCG-F180/PCG-F190

Serial Number: _____

WARNING

- To prevent fire or shock hazard, do not expose your notebook computer to rain or moisture.
- To avoid electrical shock, do not open the cabinet. Refer servicing to qualified personnel only.
- Never install modem or telephone wiring during a lightning storm.
- Never install telephone jacks in wet locations unless the jack is specifically designed for wet locations.
- Never touch uninsulated telephone wire or terminals unless the telephone line has been disconnected at the network interface.
- Use caution when installing or modifying telephone lines.
- Avoid using the modem during an electrical storm.
- Do not use the modem or a telephone to report a gas leak in the vicinity of the leak.
- A socket outlet should be as close as possible to the unit and easily accessible.

! The laser beam used in the DVD-ROM drive unit is harmful to the eyes. Do not attempt to disassemble the cabinet. Refer servicing to qualified personnel only.

AVERTISSEMENT

- Pour prévenir tout risque d'incendie ou d'électrocution, garder cet appareil à l'abri de la pluie et de l'humidité.
- Pour prévenir tout risque d'électrocution, ne pas ouvrir le châssis de cet appareil et ne confier son entretien qu'à une personne qualifiée.
- L'appareil doit être le plus près possible d'une prise murale pour en faciliter l'accès.

Regulatory Information

Declaration of Conformity

Trade Name: SONY

Model No: PCG-F150/PCG-F160/
PCG-F180/PCG-F190

Responsible Party:
Sony Electronics Inc.

Address:
1 Sony Drive
Park Ridge, NJ 07656

Telephone No.: 201-930-6970

This device complies with Part 15 of the FCC rules. Operation is subject to the following two conditions: (1) This device may not cause harmful interference, and (2) this device must accept any interference received, including any interference that may cause undesired operation.

This equipment has been tested and found to comply with the limits for a Class B digital device, pursuant to Part 15 of the Rules. These limits are designed to provide reasonable protection against harmful interference in a residential installation. This equipment generates, uses, and can radiate radio frequency energy and, if not installed and used in accordance with the instructions, may cause harmful interference to radio communications.

However, there is no guarantee that interference will not occur in a particular installation. If this equipment does cause harmful interference to radio or television reception, which can be determined by turning the equipment off and on, the user is encouraged to try to correct the interference by one or more of the following measures:

- Reorient or relocate the receiving antenna.
- Increase the separation between the equipment and the receiver.
- Connect the equipment into an outlet on a circuit different from that to which the receiver is connected.
- Consult the dealer or an experienced radio/TV technician for help.

You are cautioned that any changes or modifications not expressly approved in this manual could void your authority to operate this equipment.

Only peripherals (computer input/output devices, terminals, printers, etc.) that comply with FCC Class B limits may be attached to this computer product. Operation with non-compliant peripherals is likely to result in interference to radio and television reception.

All cables used to connect peripherals must be shielded and grounded. Operation with cables, connected to peripherals, that are not shielded and grounded, may result in interference to radio and television reception.

FCC Part 68

This equipment complies with Part 68 of the FCC rules. On the bottom of this equipment is a label that contains, among other information, the FCC equivalence number (REN) for this equipment. If requested, this information must be provided to the telephone company.

This modem uses the USOC RJ-11 telephone jack.

The REN is used to determine the quantity of devices which may be connected to the telephone line. Excessive RENs on the telephone line may result in the devices not ringing in response to an incoming call. In most, but not all areas, the sum of the RENs should not exceed five (5.0). To be certain of the number of devices that may be connected to the line, as determined by the total RENs, contact the telephone company to determine the maximum REN for the calling area.

If the terminal equipment (Notebook Computer PCG-F150/PCG-F160/PCG-F180/PCG-F190) causes harm to the telephone network, the telephone company will notify you in advance that temporary discontinuance of service may be required. But if advance notice is not practical, the telephone company will notify the customer as soon as possible. Also, you will be advised of your right to file a complaint with the FCC if you believe it is necessary.

The telephone company may make changes in its facilities, equipment, operations or procedures that could affect the operations of the equipment. If this happens, the telephone company will provide advance notice in order for you to make the necessary modifications in order to maintain uninterrupted service.

If trouble is experienced with this equipment (Notebook Computer PCG-F150/PCG-F160/PCG-F180/PCG-F190), please contact 1-888-4SONYPC (1-888-476-6972), or write to the Sony Customer Information Center, One Sony Drive, Park Ridge, NJ 07656 for repair and/or warranty information. If the trouble is causing harm to the telephone network, the telephone company may request that you remove the equipment from the network until the problem is resolved.

Repair of this equipment should be made only by a Sony Service Center or Sony authorized agent. For the Sony Service

Center nearest you, call 1-888-4SONYPC (1-888-476-6972).

This equipment cannot be used on public coin service provided by the telephone company. Connection to Party Line Service is subject to state and possible provincial tariffs. (Contact the state or provincial utility service commission, public service commission or corporation commission for information.)

Telephone Consumer Protection Act of 1991 (United States)

The Telephone Consumer Protection Act of 1991 makes it unlawful for any person to use a computer or other electronic device to send any message via a telephone facsimile machine unless such message clearly contains, in a margin at the top or bottom of each transmitted page or on the first page of the transmission, the date and time it is sent and an identification of the business, other entity, or individual sending the message, and the telephone number of the sending machine or such business, other entity, or individual.

In order to program this information into your facsimile machine, see your fax software documentation.

Telephone Consumer Guidelines (Canada)

Please refer to your telephone directory under 'Privacy Issues' and/or 'Terms of Service.' For more detailed information please contact:

CRTC
Terrasses de la Chaudière, Tour centrale
1 promenade du Portage, 5 étage Hull PQ
K1A 0N2.

This Class B digital apparatus complies with Canadian ICES-003.

Cet appareil numérique de la classe B est conforme à la norme NMB-003 du Canada.

DISPOSAL OF LITHIUM ION BATTERY

You can return your unwanted lithium ion batteries to your nearest Sony Service Center or Factory Service Center.



In some areas the disposal of lithium ion batteries in household or business trash may be prohibited.

For the Sony Service Center nearest you call 1-888-476-6972 in the United States or 1-800-961-7669 in Canada.

! Do not handle damaged or leaking lithium ion batteries.

! Ne pas manipuler les batteries au lithium-ion qui fuient ou sont endommagées.

! Danger of explosion if battery is incorrectly replaced. Replace only with the same or equivalent type recommended by the manufacturer. Discard used batteries according to the manufacturer's instructions.

! Une batterie non conforme présente un danger d'explosion. La remplacer seulement par une batterie identique ou de type équivalent recommandé par le fabricant. Évacuer les batteries usées selon les directives du fabricant.

! The battery pack used in this device may present a fire or chemical burn hazard if mistreated. Do not disassemble, heat above 212°F (100°C) or incinerate. Dispose of used battery promptly. Keep away from children.

! La manutention incorrecte du module de batterie de cet appareil présente un risque d'incendie ou de brûlures chimiques. Ne pas démonter, incinérer ou exposer à une température de plus de 100°C. Évacuer promptement la batterie usée. Garder hors de portée des enfants.

INDUSTRY CANADA NOTICE

NOTICE: The Industry Canada label identifies certified equipment. This certification means that the equipment meets certain telecommunications network protective, operational and safety requirements as prescribed in the appropriate Terminal Equipment Technical Requirements document(s). The Department does not guarantee the equipment will operate to the user's satisfaction.

Before installing this equipment, users should ensure that it is permissible to be connected to the facilities of the local telecommunications company. The equipment must also be installed using an acceptable method of connection.

The customer should be aware that compliance with the above conditions may not prevent degradation of service in some situations.

Repairs to certified equipment should be coordinated by a representative designated by the supplier. Equipment malfunctions or any repairs or alterations made by the user to this equipment may give the

telecommunications company cause to request that the user disconnect the equipment.

Users should ensure for their own protection that the electrical ground connections of the power utility, telephone lines and internal metallic water pipe system, if present, are connected together. This precaution may be particularly important in rural areas.

Caution: Users should not attempt to make such connections themselves, but should contact the appropriate electric inspection authority, or electrician, as appropriate.

NOTICE: The Ringer Equivalence Number (REN) assigned to each terminal device provides an indication of the maximum number of terminals allowed to be connected to a telephone interface. The termination on an interface may consist of any combination of devices subject only to the requirement that the sum of the Ringer Equivalence Numbers of all the devices does not exceed 5. The Ringer Equivalence Number for this equipment is 0.4.

AVIS DE L'INDUSTRIE CANADA

AVIS: L'étiquette d'Industrie Canada identifie le matériel homologué.

Cette étiquette certifie que le matériel est conforme aux normes de protection, d'exploitation et de sécurité des réseaux de télécommunications, comme le prescrivent les documents concernant les exigences techniques relatives au matériel terminal. Le Ministère n'assure toutefois pas que le matériel fonctionnera à la satisfaction de l'utilisateur.

Avant d'installer ce matériel, l'utilisateur doit s'assurer qu'il est permis de le raccorder aux installations de l'entreprise locale de télécommunication. Le matériel doit également être installé en suivant une méthode acceptée de raccordement. L'abonné ne doit pas oublier qu'il est

possible que la conformité aux conditions énoncées ci-dessus n'empêche pas la dégradation du service dans certaines situations.

Les réparations de matériel homologué doivent être coordonnées par un représentant désigné par le fournisseur. L'entreprise de télécommunications peut demander à l'utilisateur de débrancher un appareil à la suite de réparations ou de modifications effectuées par l'utilisateur ou à cause de mauvais fonctionnement.

Pour sa propre protection, l'utilisateur doit s'assurer que tous les fils de mise à la terre de la source d'énergie électrique, des lignes téléphoniques et des canalisations d'eau métalliques, s'il y en a, sont raccordés ensemble. Cette précaution est particulièrement importante dans les régions rurales.

Avertissement: L'utilisateur ne doit pas tenter de faire ces raccordements lui-même; il doit avoir recours à un service d'inspection des installations électriques, ou à un électricien, selon le cas.

AVIS: L'indice d'équivalence de la sonnerie (IES) assigné à chaque dispositif terminal indique le nombre maximal de terminaux qui peuvent être raccordés à une interface.

La terminaison d'une interface téléphonique peut consister en une combinaison de quelques dispositifs, à la seule condition que la somme d'indices d'équivalence de la sonnerie de tous les dispositifs n'excède pas 5.

Contents

Welcome

| | |
|--------------------------------|---|
| Ergonomic Considerations | 2 |
|--------------------------------|---|

Using Your Notebook Computer

| | |
|--|----|
| Locating the Controls and Connectors | 5 |
| Connecting a Power Source | 9 |
| Starting Your Computer | 14 |
| Shutting Down Your Computer | 15 |
| Registering Windows® 98..... | 16 |
| Registering Your Computer | 17 |
| Using the Keyboard..... | 18 |
| Using the Touchpad | 24 |
| Using the Floppy Disk Drive | 25 |
| Using the DVD-ROM/CD-ROM Drive | 27 |
| Using PC Cards..... | 29 |
| Using Infrared Communication Devices..... | 32 |
| Using Power Saving Modes | 34 |
| Using a Second Battery Pack..... | 36 |
| Using the Weight Saver | 38 |

Connecting Peripheral Devices

| | |
|--|----|
| Connecting a Phone Line | 42 |
| Connecting the Port Replicator | 43 |
| Connecting a Printer | 47 |
| Connecting an External Display..... | 48 |
| Connecting an External Mouse or Keyboard | 51 |
| Connecting External Speakers..... | 52 |
| Connecting an External Microphone..... | 53 |
| Connecting a Digital Still Camera or Other Serial Device | 54 |
| Connecting a Digital Video Camera Recorder..... | 55 |
| Connecting a Universal Serial Bus (USB) Device | 56 |

Customizing Your Notebook Computer

| | |
|--|----|
| Displaying the Sony Notebook Setup Screen..... | 57 |
| Controlling Power Management..... | 59 |
| Displaying Battery Information | 62 |
| Selecting the Display Mode | 65 |
| Starting Your Favorite Software with Programmable Power Key (PPK) Setup | 69 |
| Using the Dual Display Function..... | 71 |

Getting Help

| | |
|---|----|
| Troubleshooting | 75 |
| Replacing the Internal Backup Battery..... | 82 |
| Using the System and Application Recovery CDs | 84 |

| | |
|---------------------------|-----------|
| <i>Notes on Use</i> | <i>87</i> |
|---------------------------|-----------|

| | |
|---|-----------|
| <i>Limited Warranty Statement</i> | <i>93</i> |
|---|-----------|

| | |
|-------------------|-----------|
| <i>Index.....</i> | <i>99</i> |
|-------------------|-----------|

Welcome

Congratulations on your purchase of the Sony VAIO Notebook Computer. Sony has combined leading-edge technology in audio, video, computing, and communications to provide you with state-of-the-art personal computing.

About the User Guide

The User Guide offers a quick introduction and reference to your Sony Notebook computer.

- ❑ **Using Your VAIO Notebook Computer** shows you how to use the standard components of your system.
- ❑ **Connecting Peripheral Devices** explains how you can add functionality by connecting various peripherals.
- ❑ **Getting Help** explains the support options available to you and offers basic troubleshooting tips.
- ❑ **Notes on Use** provides facts and advice about using your notebook computer.
- ❑ **Limited Warranty Statement** provides your product warranty statement and explains how to extend your warranty for an additional nine months.

The online *User Guide* is included with your computer as an electronic document. It includes additional information on using the Sony software products that are installed on your computer and how to customize your Sony notebook computer.

Ergonomic Considerations

You will be using your notebook computer as a portable device in a variety of environments. Whenever possible, you should attempt to apply the following ergonomic considerations to both stationary and portable environments.

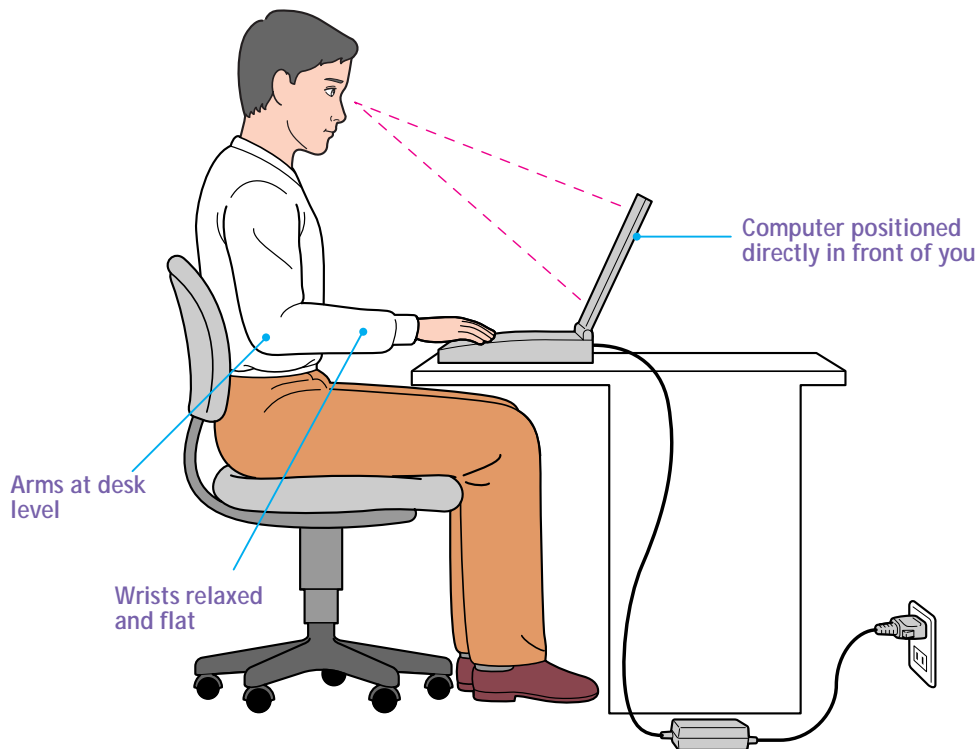

- ❑ **Position of your computer** – Place the computer directly in front of you as you work. Keep your forearms horizontal, with your wrists in a neutral, comfortable position while using the keyboard, touchpad, or external mouse. Let your upper arms hang naturally at your sides. Take breaks during sessions with your computer. Excessive use of the computer may strain muscles or tendons.
- ❑ **Furniture and posture** – Sit in a chair with good back support and armrests. Adjust the level of the chair so your feet are flat on the floor. A footrest may make you more comfortable. Sit in a relaxed, upright posture and avoid slouching forward or leaning far backward.
- ❑ **Viewing angle of the computer's display** – Use the display's tilting feature to find the best position. You can reduce eye strain and muscle fatigue by adjusting the tilt of the display to the proper position. Adjust the brightness setting of the display also.

- ❑ **Lighting** – Choose a location where windows and lights do not create glare and reflection on the display. Use indirect lighting to avoid bright spots on the display. You can also purchase accessories for your display that help reduce glare. Proper lighting adds to your comfort and work effectiveness.
- ❑ **Tilt stand** – You use the tilt stand to place the computer at an angle that allows comfortable typing.

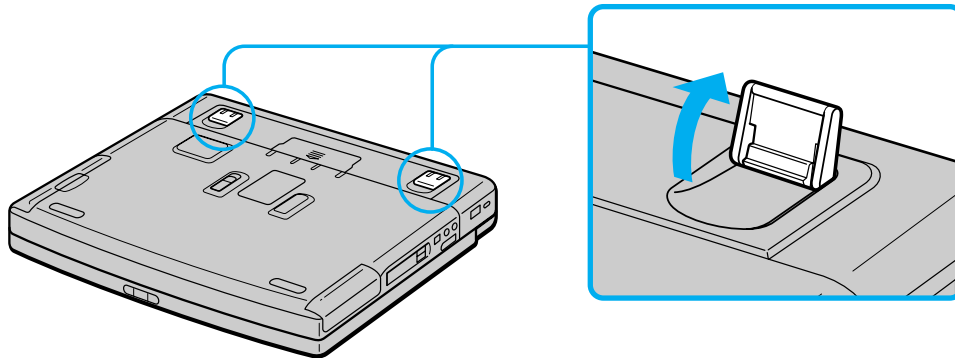

- ❑ **Placement of an external display** – When using an external display, set the display at a comfortable viewing distance. Make sure the display screen is at eye level or slightly lower when you are sitting in front of the monitor.

Using Your Notebook Computer

This section describes how to start using your computer and how to use your computer's internal and external devices, such as the touchpad, floppy disk drive, and DVD-ROM/CD-ROM drive.

Locating the Controls and Connectors

Front

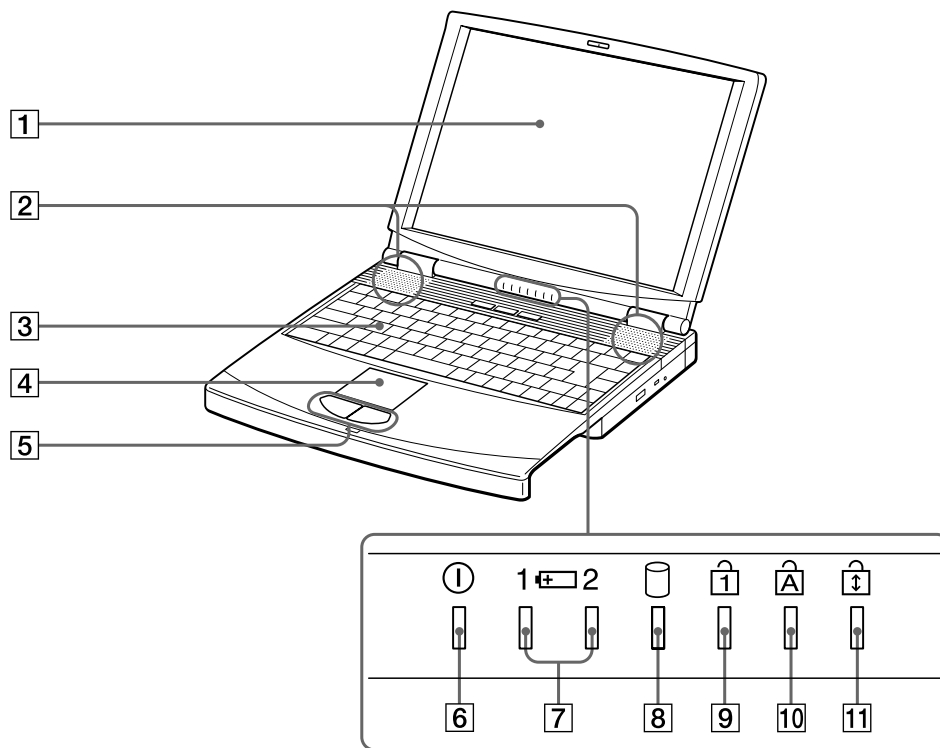

- 1 LCD screen (pages 22, 87)
- 2 Speakers (pages 22, 52)
- 3 Keyboard (page 18)
- 4 Touchpad (page 24)
- 5 Left/right buttons (page 24)
- 6 Power indicator (page 11)

- 7 Battery 1 and 2 indicators (pages 11, 21)
- 8 Hard disk drive indicator (page 21)
- 9 Num Lock indicator (page 21)
- 10 Caps Lock indicator (page 21)
- 11 Scroll Lock indicator (page 21)

Left

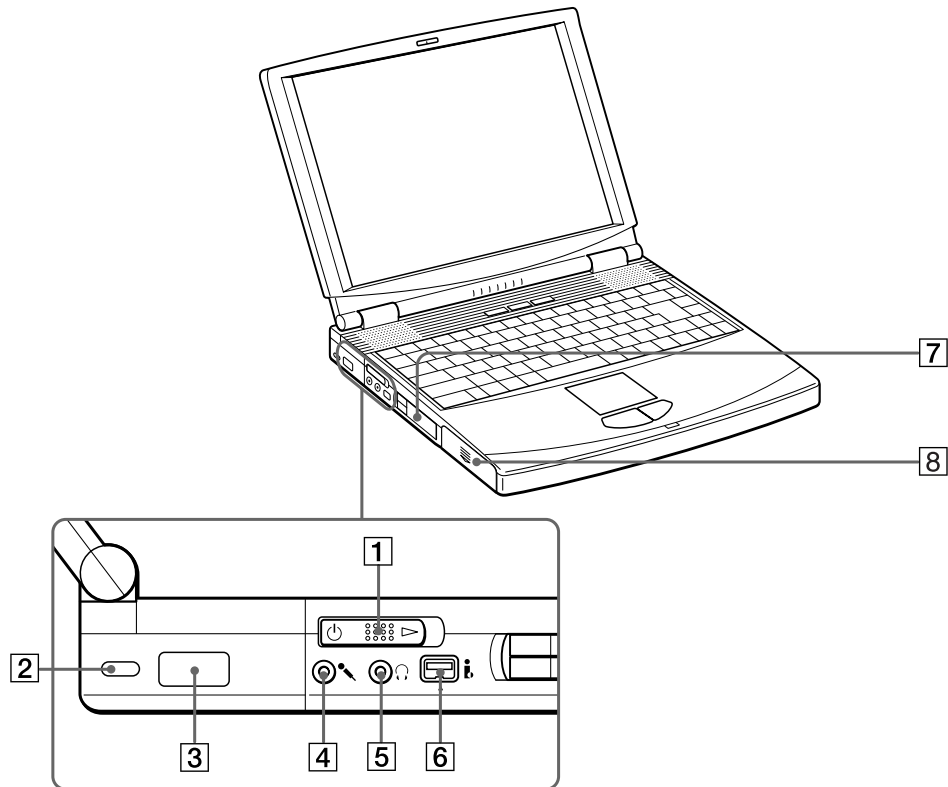

- | | | | |
|---|-------------------------------------|---|------------------------------------|
| 1 | Power switch (page 14) | 5 | Headphone connector (pages 49, 52) |
| 2 | Kensington Security Cable Lock port | 6 | S200 i.LINK™ connector (page 55) |
| 3 | Infrared port connector (page 32) | 7 | PC card slots (page 29) |
| 4 | Microphone connector (pages 49, 53) | 8 | Battery bay (page 10) |

Right

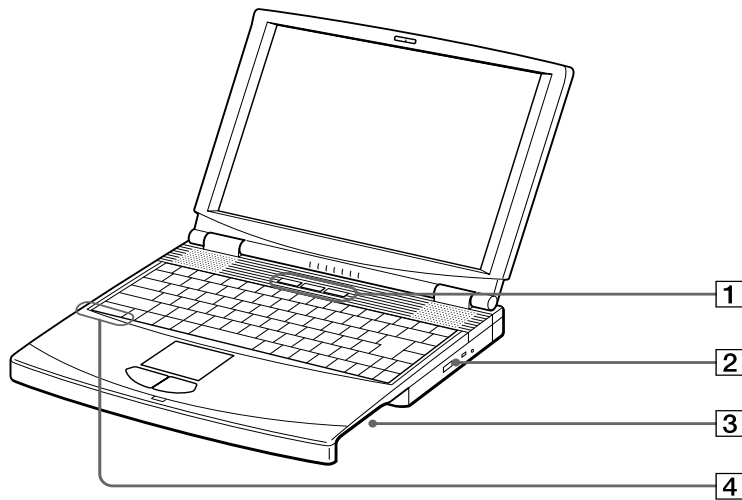

- | | |
|---|---------------------------------------|
| 1 PPK buttons (page 69) | 3 Drive bay (pages 25, 36, 38) |
| 2 DVD-ROM/CD-ROM drive (page 27) | 4 Internal microphone |

Back

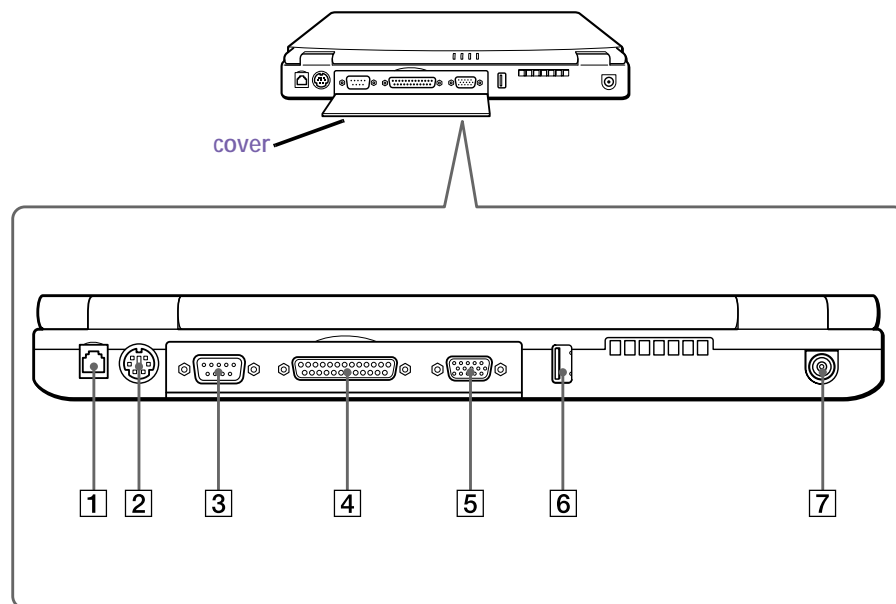

- | | |
|---|--------------------------------------|
| 1 Phone line jack (page 42) | 5 Monitor connector (page 48) |
| 2 Mouse/Keyboard connector (page 51) | 6 USB connector (page 56) |
| 3 Serial connector (page 54) | 7 DC In connector (page 9) |
| 4 Printer connector (page 47) | |

 There is a ventilation slot located between the USB connector and the DC In connector. Do not cover the ventilation slot when your computer is on.

Bottom

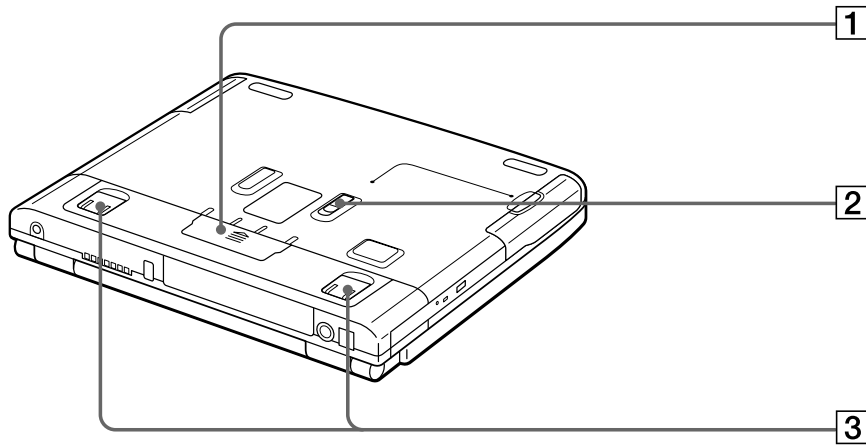

1 Port replicator connector cover (pages 44, 46)

3 Tilt stands

2 Drive bay RELEASE lever (pages 37, 39)

Connecting a Power Source

You can use either AC power or a rechargeable battery pack as a power source.

Using the AC Adapter

- 1 Plug the cable attached to the AC adapter into the DC In connector on the computer.
- 2 Plug one end of the power cord into the AC adapter.
- 3 Plug the other end of the power cord into an AC outlet.

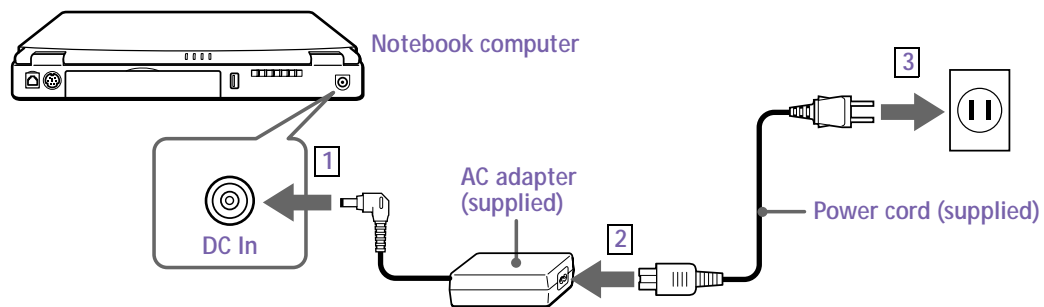

Using Battery Power

You can use one or two battery packs as a source of power. The second battery pack inserts into the drive bay on the right side of the computer. (See “Using Power Saving Modes” on page 34.) Additional battery packs are available as a separate option.

The battery pack that comes with your computer is not fully charged at the time of purchase. Follow the steps below to insert and charge the battery pack.

To insert the battery pack

- 1 Open the cover of the battery bay.

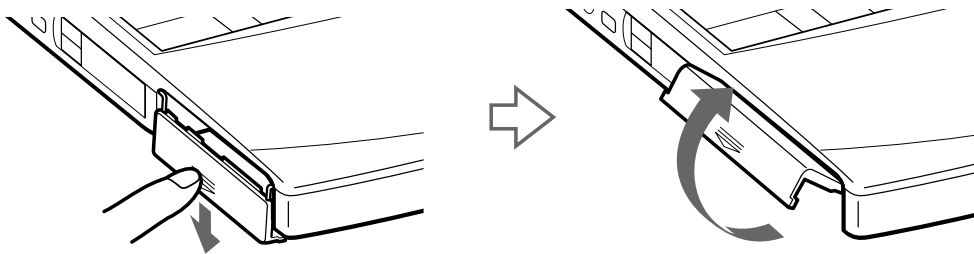

- 2 Insert the battery pack into the battery bay on the left side of the computer.

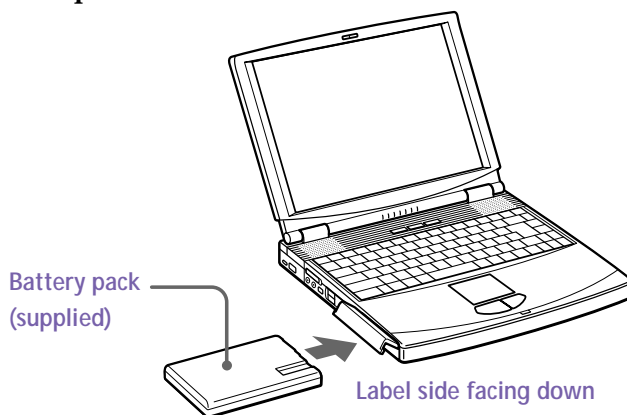

- 3 Close the cover of the battery bay until it clicks.

 When attaching your computer to the port replicator, do not attempt to insert or remove the battery pack. Lifting and turning the computer with an attached docking station could cause a temporary loss of power.



To charge the battery pack

- 1 Connect the AC adapter to the computer.
- 2 Insert the battery pack.

The computer automatically charges the battery (the battery indicator light flashes in a double blink pattern as the battery charges). When the battery is 85 percent full, the battery indicator light turns off. This process takes approximately two hours. To charge the battery completely, continue charging for an additional hour. See “Displaying Detailed Battery Information” on page 63 for information on checking the battery life.

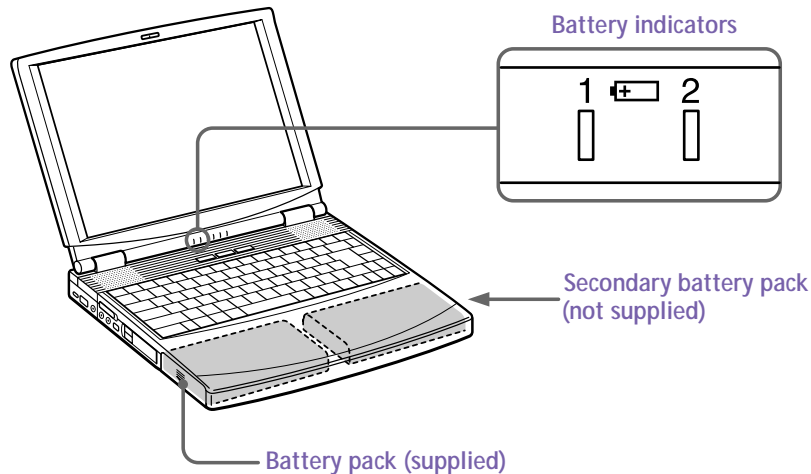
There are two battery indicator lights on the computer:



| <i>Battery Indicator</i> | <i>Meaning</i> |
|---|---|
| 1  | Indicates the status of the battery pack in the battery bay on the left side of the computer. |
|  2 | Indicates the status of the battery pack in the drive bay on the right side of the computer. |

| <i>Battery Indicator Light Status</i> | <i>Meaning</i> |
|---------------------------------------|--------------------------------------|
| On | The computer is using battery power. |
| Single blink | The battery is running out of power. |
| Double blink | The battery is charging. |
| Off | The computer is using AC power. |

 To determine the amount of time the battery lasts, see “Displaying Battery Information” on page 62.

When the battery is running out of power, both the battery and power indicators blink.

When the computer is directly connected to AC power and has a battery pack in the battery bay, it uses power from the AC outlet.

See "Using a Second Battery Pack" on page 36 for information on installing and charging a battery pack in the drive bay.

Keep the battery pack in the computer while it is directly connected to AC power. The battery pack continues to charge while you are using the computer.

If the battery level falls below 10%, you should either attach the AC adapter to recharge the battery or shut down your computer and insert a fully charged battery.

You can extend battery life by changing the power management modes in the PowerPanel utility. See "Using Power Saving Modes" on page 34.

The battery pack supplied with your computer is a lithium ion battery and can be recharged at any time. Charging a partially discharged battery does not affect battery life.

The battery indicator light is on while you use the battery pack as a power source. When battery life is nearly depleted, the battery indicator starts flashing.

For some software applications and some peripheral devices, your computer may not enter System Hibernation mode when the battery life is low. To avoid loss of data when using battery power, you should save your data frequently and manually activate a power management mode, such as System Suspend or System Hibernation.

To remove the battery pack

- 1 Open the cover of the battery bay.**
- 2 Pull out the battery pack.**

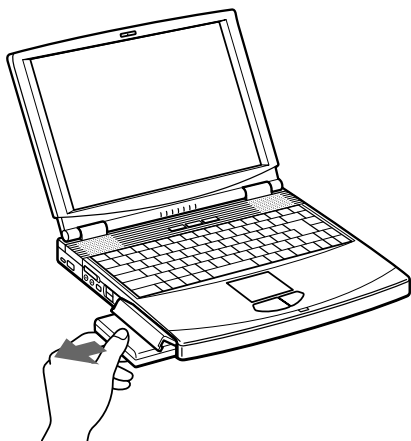

3 Close the cover of the battery bay.

! You may lose data if you remove the battery pack while the computer is on and not connected to the AC adapter or if you remove the battery while the computer is in System Suspend mode.

Starting Your Computer

- 1 Slide the LCD lock lever in the direction of the arrow, and lift the cover.

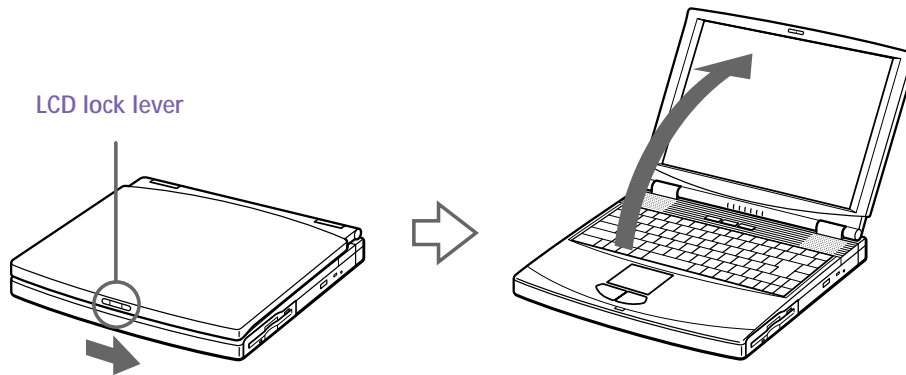

- 2 Slide the power switch on the left side toward the front of the computer until the green power indicator light turns on.

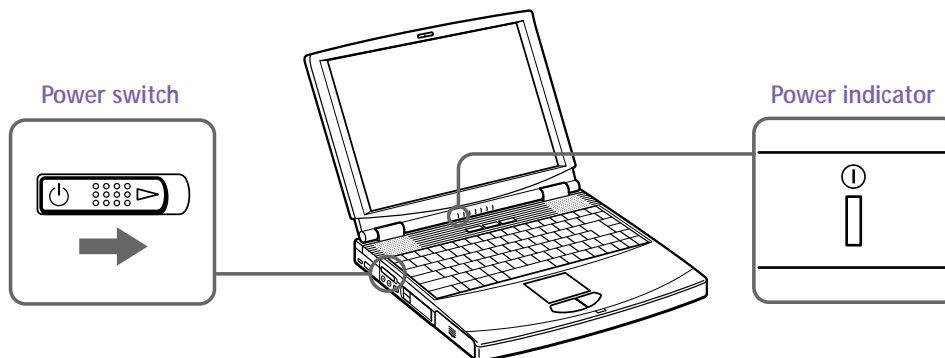

 If you hold the power switch in the On position for more than four seconds, the computer turns off.

- 3 If necessary, adjust the brightness controls for the LCD display. To decrease the brightness, press Fn+F5 and then the down or left arrow key. To increase the brightness, press Fn+F5 and then the up or right arrow key.

Shutting Down Your Computer

! To avoid potential loss of data, follow these steps to shut down your computer.

- 1 Click the Start button on the Windows 98 taskbar.
- 2 Click Shut Down at the bottom of the Start menu to display the Shut Down Windows dialog box.



- 3 Select Shut down.
- 4 Click OK.

 Respond to any prompts warning you to save documents.

- 5 Wait for your computer to turn off automatically. The power indicator (green) turns off.
- 6 Turn off any peripherals connected to your computer.

 If you are unable to shut down your computer using the steps described above, press the Ctrl+Alt+Delete keys at the same time to restart the computer. If you are unable to restart the computer in this way, you can slide the power switch forward and hold for four seconds. This operation may result in data loss.

During a period of inactivity, you can conserve battery life by using System Suspend mode. See "Controlling Power Management" on page 59.

Registering Windows® 98

The first time you turn on your computer, you need to complete a few steps to register and configure the Windows 98 software that is already installed.

 You must register Windows 98 before you can use the computer.

The on-screen instructions guide you through the registration and configuration process. The following is an overview of the process.

1 Gathering information:

- Enter your name.
- Read and accept the License Agreement.
- Enter your Certificate of Authenticity number located on the cover of the Microsoft Windows 98 *Getting Started* manual.

2 Windows 98 setup:

Click the Finish button on the Windows 98 Setup Wizard screen.

3 Selecting your computer settings:

If necessary, change the Time Zone, Date and Time on the Date/Time Properties screen.

4 Registering your computer:

For details on registering your computer, see “Registering Your Computer” on page 17. You can also sign up for your 100 free hours of Internet service at this time.

5 Learning about Windows 98:

If you wish, take the tour of Windows 98.

Registering Your Computer

You can take advantage of Sony's commitment to quality customer support and receive the following benefits by registering your computer with Sony.

- ❑ **Sony Customer Support** – Talk to a Support Representative to troubleshoot problems you may be having with your computer.
- ❑ **Extended Limited Warranty** – Protect your investment. Extend your Warranty nine months for a total of 12 months from the original date of purchase when you register your computer.
- ❑ **Express service** – Provides convenient resolution of problems.
- ❑ **Free Internet access** – Use the Internet for up to 100 free hours when you sign up with GTE (no credit card necessary). Free access expires 100 hours or 60 days after signing up, whichever occurs first.

If you have not already registered, follow these steps to use your notebook computer's online registration service.



You must connect your phone line before using any online services, including the online registration service. See "Connecting a Phone Line" on page 42.

- 1 Click the Sony VAIO Registration icon on the VAIO desktop.
- 2 Enter the information requested on the first online registration form. Press the Tab key to move from box to box.
- 3 Click the Next button to advance to the next form.
- 4 Complete the remaining forms by clicking the Next button each time you complete a form.



The computer automatically transfers your registration information using your built-in modem and a toll-free telephone number.

Using the Keyboard

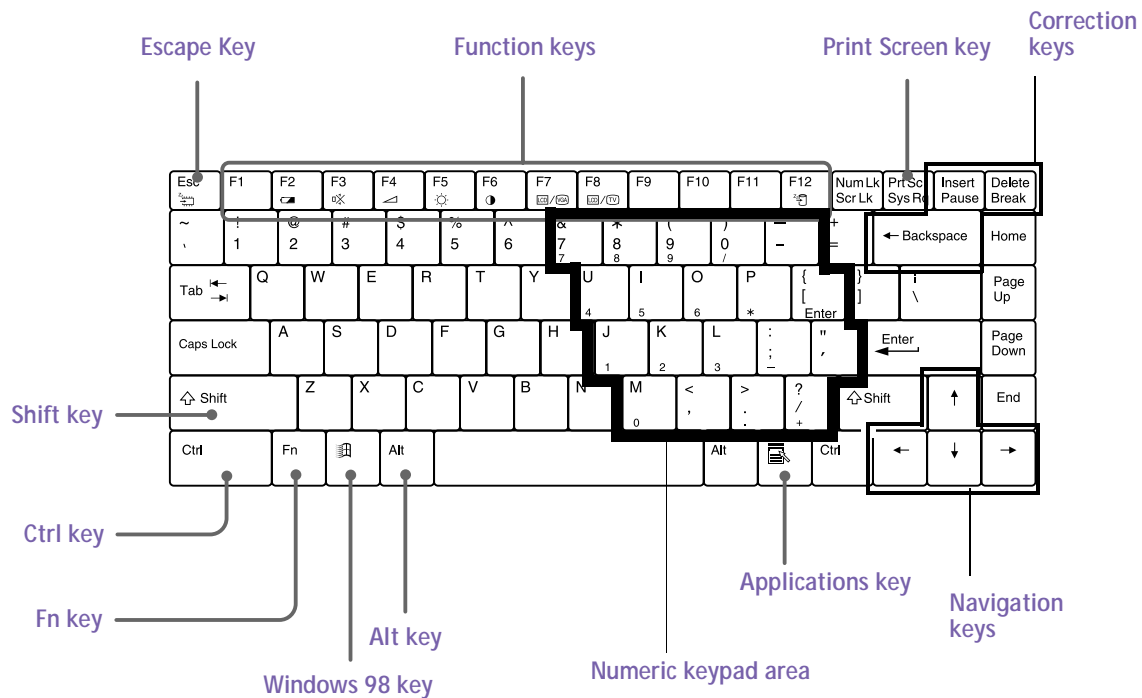







Your keyboard is very similar to a typewriter's, but the keyboard has additional keys that perform specific computer-related tasks.





| Key | Description |
|---------------------|---|
| Numeric keypad area | Contains the keys found on a typical calculator. Use the numeric keypad area to type numbers or to perform mathematical calculations such as addition and subtraction. Note that you must press the Num Lock key to activate the numeric keypad. (When you do so, the Num Lock light will be on.) |
| Navigation keys | Several keys are devoted to moving the cursor on the screen. |
| Correction keys | The Insert, Back Space, and Delete keys enable you to make corrections in your documents. |
| Function keys | The twelve function keys along the top of the keyboard are used to perform designated tasks. For example, in many applications, F1 is the Help key. The task associated with each function key may vary from one application to the next. |
| Escape key | The Esc (Escape) key is used to cancel commands. |

| <i>Key</i> | <i>Description</i> |
|---|--|
| Print Screen key | The Print Screen key takes an electronic snapshot of the screen and places it in the Windows Clipboard. You can then paste the screen shot into a document and print it. |
| Operator keys | Several keys are always used with at least one other key: Ctrl, Alt, and Shift. When held down with another key, the Ctrl (Control) and Alt (Alternate) keys offer another way to give commands. For example, in many applications, instead of choosing the Save command from a menu, you can hold down Ctrl and press S (referred to as Ctrl+S). The Shift key operates the same way as on a typewriter; it is used to produce capital letters or special symbols such as @ and \$. |
| Windows 98 key  | The key with the Windows logo displays the Windows 98 Start menu; it is the equivalent of clicking the Start button on the taskbar. See “Combinations and Functions with the Windows 98 Key” on page 20. |
| Fn key | The Fn key is used in combination with other keys to issue commands. See “Combinations and Functions with the Fn Key” on page 22. |
| Applications key  | The Applications key displays a shortcut menu of context-sensitive choices. Pressing this key is the equivalent of clicking the right mouse button. |

Combinations and Functions with the Windows 98 Key













| <i>Combination</i> | <i>Function</i> |
|---|--|
|  + F1 | Displays Windows Help. |
|  + Tab | Switches the selected button on the taskbar. |
|  + E | Displays Windows Explorer. |
|  + F | Displays the Windows Find: All Files window to find a file or folder. This is the equivalent of selecting Find and then Files or Folders from the Start menu. |
|  + Ctrl + F | Displays the Windows Find: Computer window where you can locate other computers. This is the equivalent of selecting Find and then Computer from the Start menu. |
|  + M | Minimizes all displayed windows. |
| Shift +  + M | Returns all minimized windows to their previous size. |
|  + R | Displays the Run window. This is the equivalent of selecting Run from the Start menu. |
| Fn +  + Insert | Displays the Properties window. This is the equivalent of double-clicking the System icon in the Control Panel. |

Indicators

| <i>Indicator</i> | <i>Function</i> |
|--|---|
| Power ① | Light is green when the power to the computer is turned on. Light is red in System Idle mode, and flashes red in System Suspend mode. Turns off when the computer is in System Hibernation mode or powered off. |
| Battery 1 1  | Indicates the status of the battery inserted in the battery bay on the left side of the computer. |
| Battery 2  2 | Indicates the status of the battery inserted in the drive bay on the right side of the computer. |
| Hard disk  | Lights when data is being read from or written to the hard drive. Do not enter System Suspend mode or turn off the computer when this indicator light is on. |

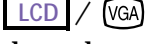
| <i>Light</i> | <i>On</i> | <i>Off</i> |
|--------------|--|--|
| Num Lock | The number keys in the numeric keypad are active. | The alphanumeric character keys in the keypad area are active. |
| Caps Lock | The letters appear in uppercase as you type. The Shift key lowers the case of typed letters when Caps Lock is on. | Letters appear in lower case as you type (unless you hold down the Shift key). |
| Scroll Lock | The screen scrolls differently. (Exactly how it scrolls depends on the specific application. It has no effect in many applications.) | Information moves across the display normally. |

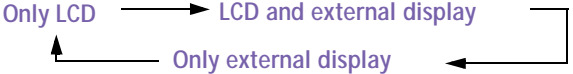
Combinations and Functions with the Fn Key

| Combinations/ Feature | Function |
|--|--|
| Fn+  (ESC) System Suspend | Puts the system into System Suspend mode, a power management state. To return the system to the active state, press any key or press the power switch on your computer. |
| Fn+  (F2) Display power source status | Displays the power source status, as in the example below: <div style="display: flex; justify-content: space-around; align-items: center; margin-top: 10px;"> <div style="text-align: center;">  <p>Using AC power</p> </div> <div style="text-align: center;">  <p>Charging a battery pack</p> </div> </div> |
| Fn+  (F3) Mute On/Off | Toggles the built-in speaker off and on. |
| Fn+  (F4) Speaker volume | Adjusts the built-in speaker volume. To increase volume, press Fn+F4, then ↑ or → . To decrease volume, press Fn+F4, then ↓ or ← . |
| Fn+  (F5) Brightness control | Adjusts the brightness of the LCD. To increase light intensity, press Fn+F5 and then ↑ or → . To decrease light intensity, press Fn+F5 and then ↓ or ← . |
| Fn+  (F6) Contrast control | Contrast control display.* Adjusts the contrast. To increase the contrast, press Fn+F6, then ↑ or → . To decrease contrast, press Fn+F6, then ↓ or ← . |
| Fn+  (F7) Switch to the external monitor/LCD | Toggles through the LCD, external display (connected to the  Monitor connector) and both LCD and external display. <div style="text-align: center; margin-top: 10px;">  </div> |
| Fn+F8 | Not available on this model. |
| Fn+  (F12) System Hibernation | Provides for the lowest level of power consumption. When you execute this command, the state of the system and state of the peripheral devices are written to the hard disk and the system power is turned off. To return the system to the original state, use the power switch to turn on power. |

| <i>Combinations/ Feature</i> | <i>Function</i> |
|---|---|
| Fn+E Eject DVD-ROM/ CD-ROM | Ejects the DVD-ROM/CD-ROM drive. [†] |
| Fn+D Video standby | Turns off the LCD in order to save power. To turn the LCD back on, press any key. |
| Fn+F Change the display size | Zooms the display size in or out when the display is set to a low resolution. |
| Fn+S System Idle | Puts the system into System Idle mode, a power management state. To return the system to the active state, press any key. |

* The Fn+F6 (contrast control) function is available on model PCG-150 only.

† The DVD-ROM drive is available on models PCG-F180/PCG-F190. The CD-ROM drive is available on models PCG-F150/PCG-F160.



Some functions are not available until Windows launches.

Using the Touchpad

The keyboard contains a cursor-pointing device called a touchpad. You can point to, select, drag, and scroll objects on the screen using the built-in touchpad.

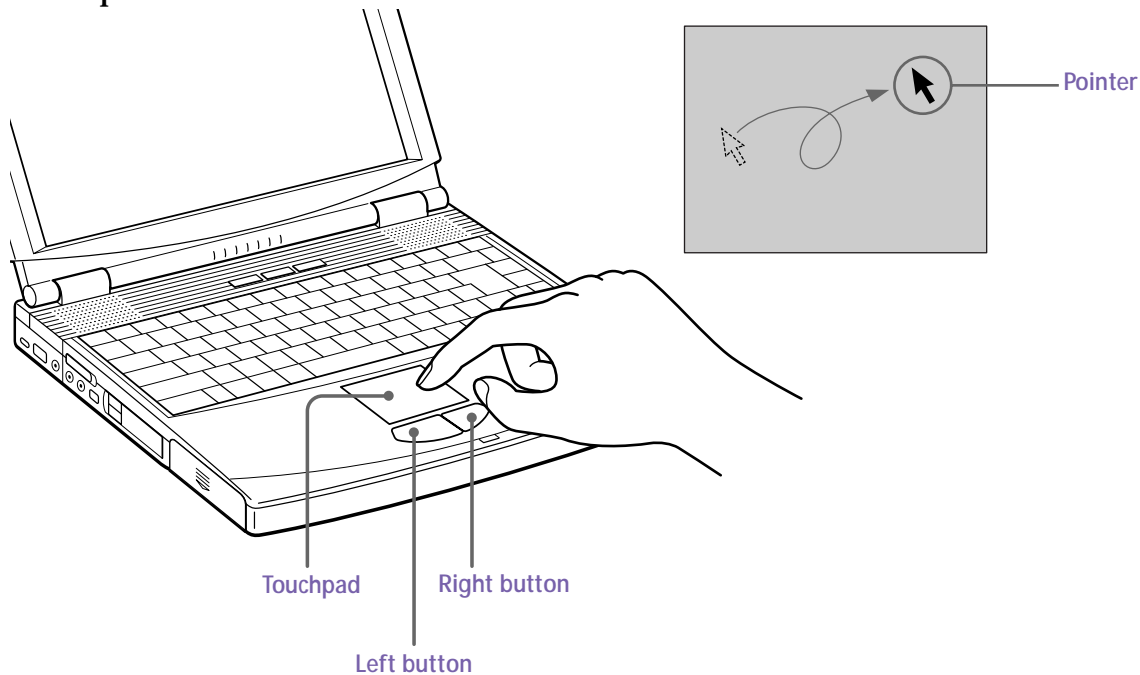

| <i>Action</i> | <i>Description</i> |
|---------------------|---|
| Point | Slide one finger on the touchpad to place the pointer on an item or object. |
| Click | Press the left button once. |
| Double-click | Press the left button twice. |
| Right-click | Press the right button once. In many applications, this action displays a shortcut menu of context-sensitive choices. |
| Drag | Slide one finger while pressing the left button. |
| Scroll | Move your finger along the right edge of the touchpad to scroll vertically. Move your finger along the bottom to scroll horizontally. (The scroll function is available only with applications that support a touchpad scroll feature.) |

 See Mouse Help for information on touchpad features, such as clicking both buttons simultaneously, adjusting touchpad speed, and Easy Launcher functions. To access Mouse Help, press the Start button, select Settings, and then select Control Panel. Click the Mouse icon in the Control Panel and click the Help button.

Using the Floppy Disk Drive

The computer comes with the floppy disk drive in the drive bay.

To insert a diskette

- 1 Hold the diskette with the label side facing up.
- 2 Gently push the diskette into the drive until it clicks into place.

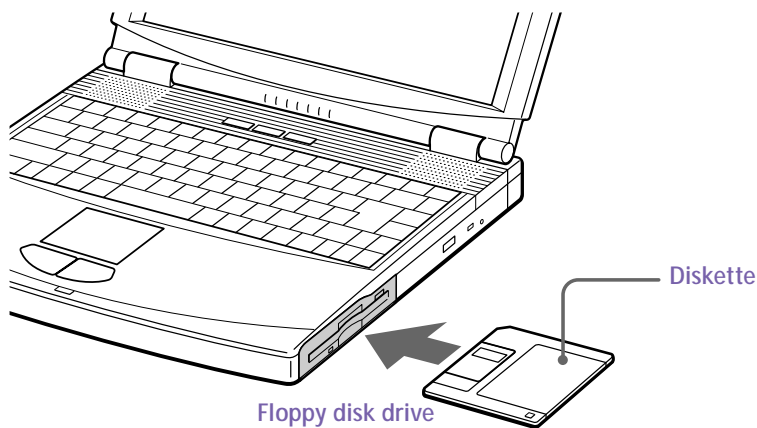

To remove a diskette

- ❑ When you finish using the diskette, wait until the LED indicator turns off and then press the Eject button to remove the diskette.

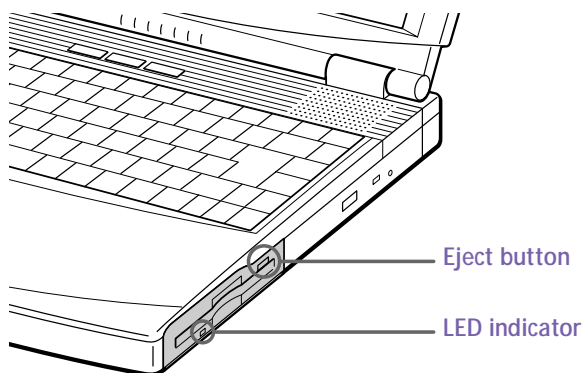

 Do not press the Eject button when the LED indicator is turned on. Otherwise, data may be lost.

If you have difficulty removing a diskette from the floppy disk drive, remove the floppy disk drive from the drive bay.

To remove the floppy disk drive

- 1 Turn off the computer.
- 2 There is a RELEASE lever on the bottom of the computer. Slide this lever in the direction of the arrow.

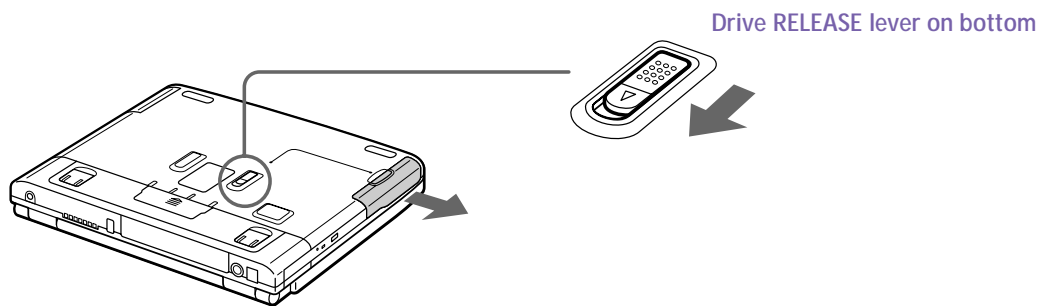

- 3 Slide the drive out of the drive bay.
- 4 Insert the weight saver. See “Using the Weight Saver” on page 38.

To reinsert the floppy disk drive

- 1 Turn off the computer.
- 2 If another device is in the drive bay, remove the device. See “To remove the floppy disk drive” on page 26 or “To remove the second battery pack” on page 37.
- 3 Insert the floppy disk drive into the drive bay with the VAIO label facing up. Continue pushing the drive into the bay until the RELEASE lever locks into place.

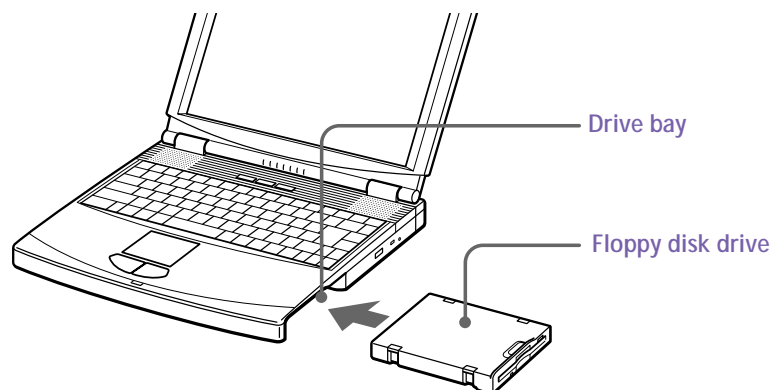

Using the DVD-ROM/CD-ROM Drive

Your computer comes with a DVD-ROM drive (models PCG-F180/F190) or CD-ROM drive (models PCG-F150/F160). If your computer is equipped with a DVD-ROM drive, you can play both DVD-ROMs and CD-ROMs.

To insert a disc

1 Turn on the computer.

 When the computer is in System Suspend or System Hibernation mode, you cannot insert a disc. See "Controlling Power Management" on page 59 for more information on System Suspend and System Hibernation modes.

2 Press the Eject button to open the DVD-ROM/CD-ROM drive.

The tray slides out.

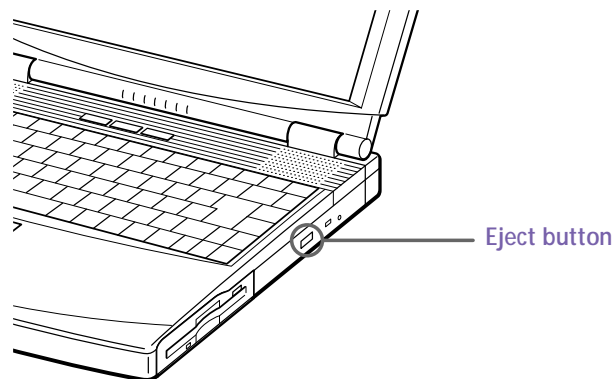

3 Place a DVD-ROM/CD-ROM in the tray with the label side facing up. For DVD-ROMs, which can be played on both sides, the side of the disc facing up is the side that plays. Push the disc onto the hub until the disc clicks into place.

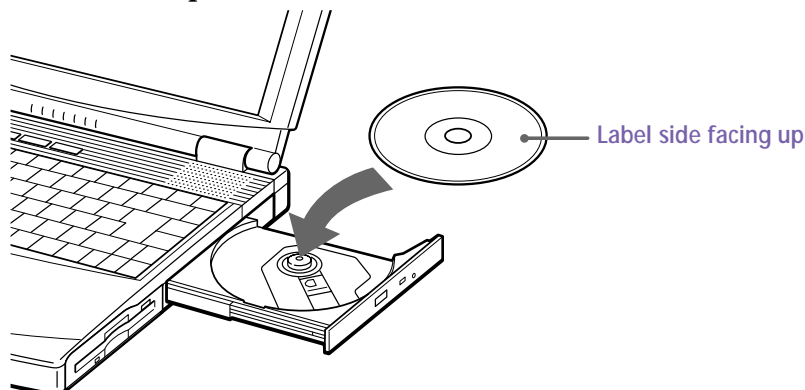

4 Close the tray by pushing it gently.

 Be sure to seat the disc firmly over the DVD-ROM/CD-ROM drive hub fingers. If you do not seat the disc firmly, you could damage your DVD-ROM/CD-ROM drive and you may not be able to open the tray.

When you finish using a disc, wait until the LED indicator turns off, then press the Eject button to remove the disc.

When the computer is in System Suspend or System Hibernation mode, you cannot remove a disc. See “Controlling Power Management” on page 59 for more information about System Suspend and System Hibernation modes.

If the disc does not come out when you press the Eject button, turn off the computer and insert a thin, pointed object into the manual eject hole.

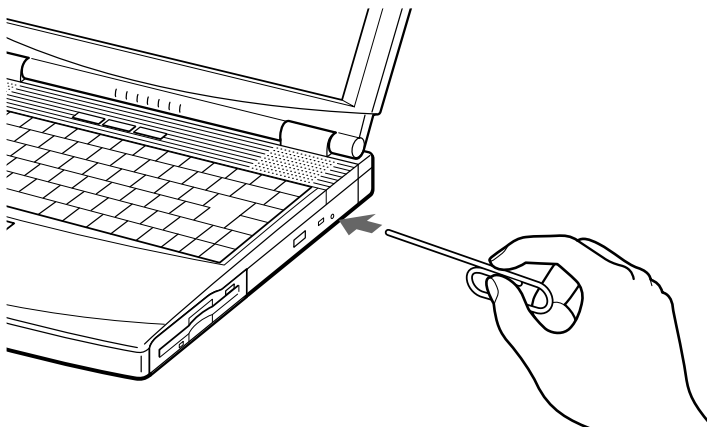

To play DVD-ROMs

To achieve optimum performance when playing DVD-ROMs, you should use the following recommendations: Your computer should not be connected to the port replicator while playing DVD movies or using DVD applications. Close any open applications before playing a DVD-ROM movie. The DVD player automatically adjusts the screen properties when you play a DVD movie. Depending on the display setup properties you have selected, you may need to use the Fn + F command to expand the movie to full screen size.

 When playing DVD movies on battery power, set the power management profile to Maximum Performance. With other profiles, the movies are choppy.

Using PC Cards

Your computer includes two PC card slots. PC cards allow you to connect portable external devices such as another hard disk drive, or to connect a network.

 The PC card slots can accommodate (at the same time) two Type I, two Type II, or one Type III PC card. These slots are compatible with Card Bus.

Some PC cards may require that you disable idle devices when using the PC card. You can use Sony Notebook Setup to disable devices. See "Displaying the Sony Notebook Setup Screen" on page 57 for details.

Be sure to use the most recent software driver provided by the PC card manufacturer.

If an "!" mark appears on the Device Manager tab in the System Properties dialog box, remove the software driver and then reinstall it.

You may not be able to use some PC cards or some functions of the PC card with this computer.

To insert a PC card

Use the lower slot for Type III PC cards.

 You do not need to shut down the computer before inserting or removing a PC card.

- 1 Pull the PC card release button up away from the computer and push it in toward the computer.

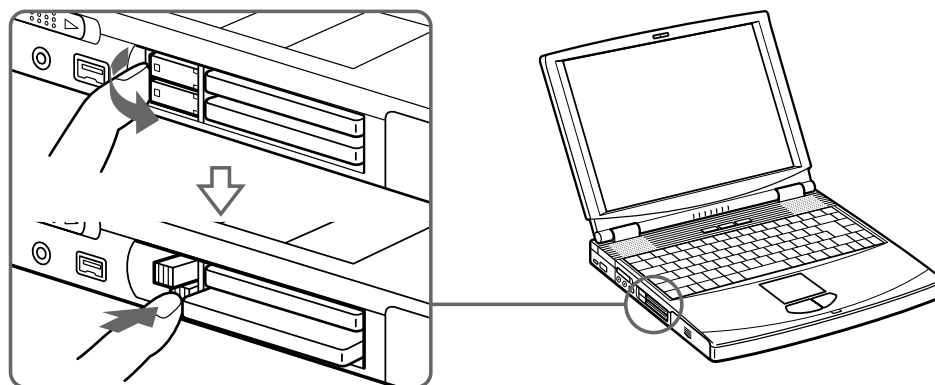

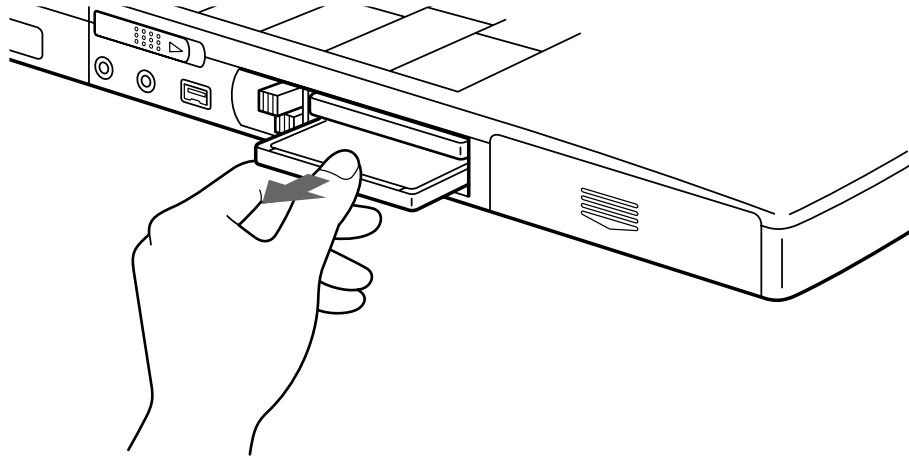

2 Remove the PC card slot protector.

When you use a Type III PC card, you need to remove both the top and bottom PC card slot protectors.

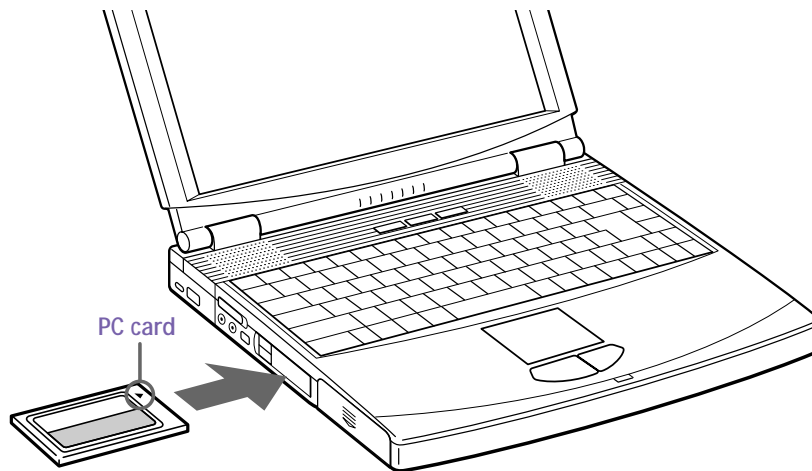

3 Insert the PC card into the PC card slot, front label facing up. Gently push the card into the slot until the card is fixed into the connector. The release button comes out.



 Do not force a card into the slot. It may damage the connector pins. If you have difficulty inserting a card, check that you are inserting the card with the correct orientation. See the manual that came with your PC card for more information on use.

For some PC cards, if you alternate between normal power operation and the System Suspend or System Hibernation power management modes while the card is inserted, you may find that a device connected to your system is not recognized. Reboot your system to correct the problem.

To remove a PC card

- 1 Close any applications that are using the PC card.
- 2 Click the PC card icon in the taskbar and close the card.
- 3 Pull the PC card release button up and press it in toward the computer.
- 4 Gently grasp the card and pull it out.
- 5 Insert the PC card slot protector back into the empty slot.

Using Infrared Communication Devices

Your computer includes an infrared port, located on the left side. You can use this port to communicate with other infrared-equipped devices with compatible protocols, such as a digital still camera or other computers.

To use infrared communication with a digital still camera

Align the infrared ports on the computer and the digital camera so that they are in a direct line.

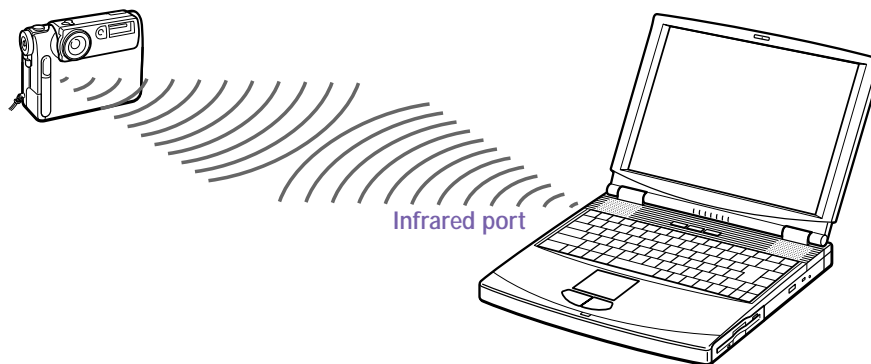

To use infrared communication with another computer

Align the infrared ports on the two computers so that they are in a direct line.

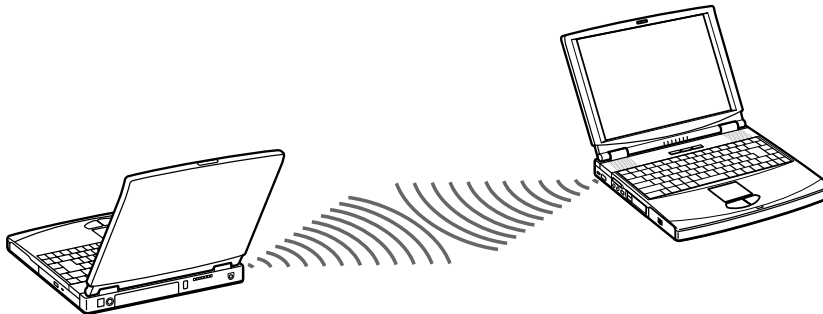

 Infrared communication capability can be turned on and off. By default, it is not enabled when your system is shipped. To enable infrared use, click the infrared icon in the Windows Control Panel and select the Enable infrared communication checkbox on the Options tab.

You can disable infrared communication when you are not using it to conserve battery life.

Use the infrared icon in the Windows Control Panel to enable and disable infrared communication. Do not use the icon in the taskbar.

Check the Status tag of the Infrared Monitor in the Windows Control Panel to determine if the infrared device is detected.

If the two devices are too far apart or too close together, data transfer may be interrupted or there may be noise in the transmission.

Do not cover the infrared ports with your hand or any other object.

Avoid direct sunlight, fluorescent light, or flashing incandescent light near the infrared ports.

See the manual that came with your digital still camera or other infrared communication device for more information on installation and use.

The active area of infrared transmission extends about 39 ³/₈ inches (1 meter) with a radius of 15 degrees.

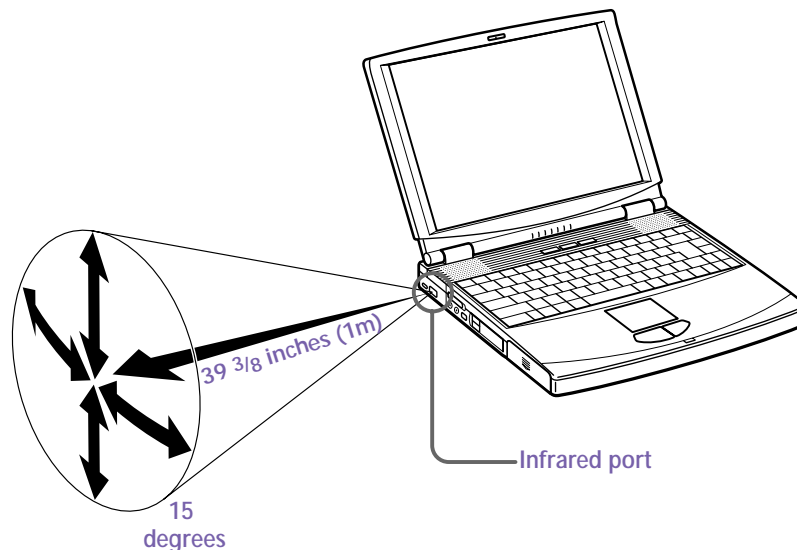

Using Power Saving Modes

When you use a battery as the source of power for your computer, you can take advantage of power management settings to conserve battery life. In addition to the normal operating mode, which allows you to turn off specific devices, your computer has three distinct power saving modes: System Idle, System Suspend, and System Hibernation. When using battery power, you should be aware that the computer automatically enters System Hibernation mode when the remaining battery charge drops below 7 percent, regardless of the power management setting you select.



If the battery level falls below 10 percent, you should either attach the AC adapter to recharge the battery or shut down your computer and insert a fully charged battery.

Normal Mode

This is the normal state of your computer when it is in use. The green power indicator light is on in this mode. To save power, you can turn off a specific device such as the LCD or the hard disk.

System Idle Mode

This mode is convenient if you do not need to use your computer for a brief period. The hard disk and video display enter a low power state, and the CPU clock and processor stop. The power indicator light is red in this mode.

To activate System Idle mode

Press **Fn+S**, or use the PowerPanel utility.

To return to normal mode

Press any key. Note that resuming from System Idle using the touchpad or mouse is not possible. You must press a key, a PPK, or the power switch.

System Suspend Mode

The computer saves the current state of the system in RAM and switches off power to the CPU. The red power indicator light flashes in this mode.

To activate System Suspend mode

Press Fn+Esc, or slide the power switch forward and release it immediately. You can also use the PowerPanel utility to enter System Suspend mode.

To return to normal mode

Press any key.

System Hibernation Mode

The state of the system is saved on the hard drive and power is turned off. The power indicator light is off in this mode.

To activate System Hibernation mode

Press Fn+F12. The “Save to Disk Manager” screen appears, and then the computer enters System Hibernation mode. You can also use the PowerPanel utility to enter System Hibernation mode.

To return to normal mode

Turn on the computer by sliding the power switch forward. The computer returns to its previous state.



When returning from System Hibernation mode, the system status stored on the hard disk is erased and the computer starts normally if you slide the power switch forward and hold for more than four seconds.

- Time to return to normal mode**
System Idle requires less time than System Suspend, and System Suspend requires less time than System Hibernation.
- Power consumption**
System Idle uses more power than System Suspend, and System Suspend uses more power than System Hibernation.

Using a Second Battery Pack

You can purchase a second rechargeable battery pack. With two battery packs, you can extend the time that you use your computer with battery power. When using two battery packs, the battery pack you insert first charges first. The battery pack you insert second charges when the first battery pack is 85 percent full. You can monitor which battery pack is charging by observing the battery indicator lights.

To insert a second battery pack

- 1 If another device is in the drive bay, remove the device. See “To remove the floppy disk drive” on page 26.
- 2 Insert the battery pack into the drive bay.

If the battery is being used, the battery 2 indicator light turns on.

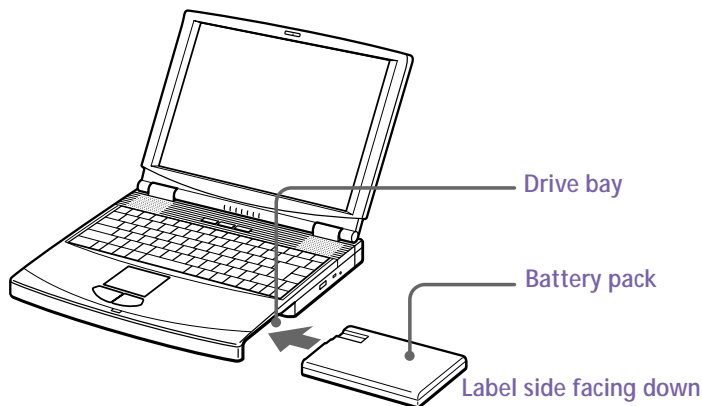

- 3 Attach the weight saver to the computer to stabilize the battery pack. See also “Using the Weight Saver” on page 38.

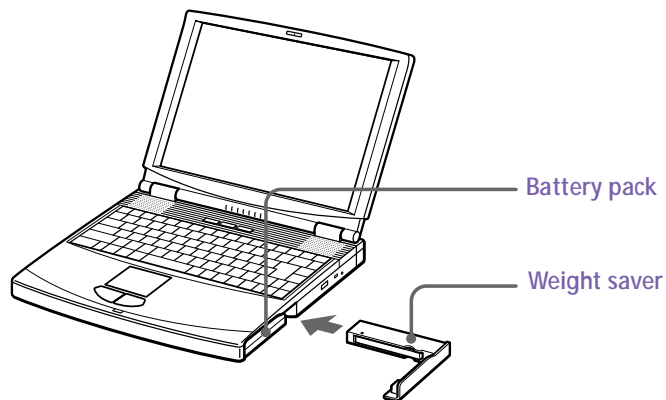

To charge the second battery pack

Keep the battery pack in the computer while it is connected to AC power. The battery indicator flashes while the battery is charging. See also “To charge the battery pack” on page 11 for more information.

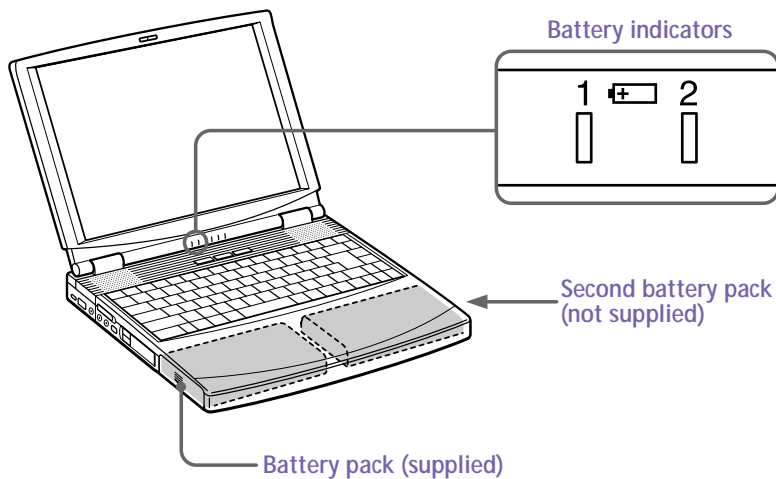

 To determine the amount of time the battery lasts, see “Displaying Battery Information” on page 62.

To remove the second battery pack

- 1 There is a Release lever on the bottom of the weight saver. To remove the battery pack, slide this lever in the direction of arrow 1, then slide the RELEASE lever on the bottom of the computer in the direction of arrow 2.

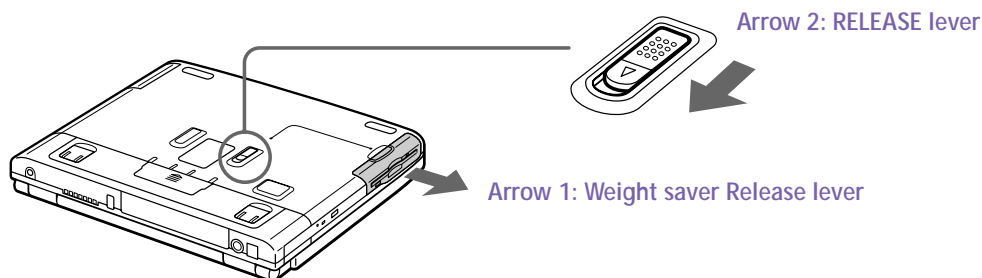

- 2 Remove the weight saver, and then pull out the battery pack.
- 3 Reinsert the weight saver. See “Using the Weight Saver” on page 38.

Using the Weight Saver

The weight saver protects the drive bay when it is empty.

To attach the weight saver

- 1 If another device is in the drive bay, remove the device. See “To remove the floppy disk drive” on page 26 or “To remove the second battery pack” on page 37.
- 2 Fold out the hinged arm of the weight saver and then push on the hinged arm to lock it into place. Slide the weight saver in the direction of the arrow until it clicks.

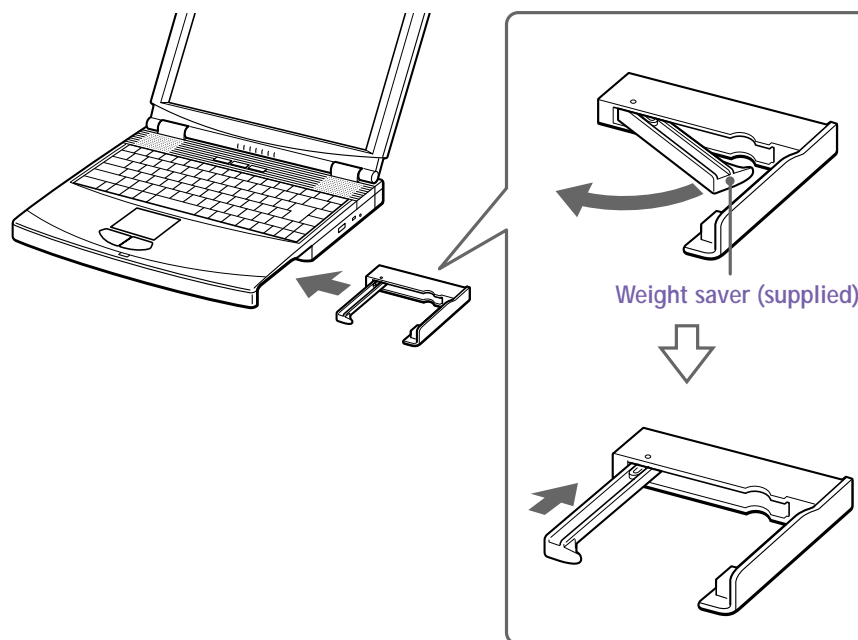

- 3 Manually lock the weight saver's RELEASE lever.

To remove the Weight Saver

- 1 There is a release lever on the bottom of the weight saver. To remove the weight saver, slide this lever in the direction of arrow 1, then slide the RELEASE lever on the bottom of the computer in the direction of arrow 2.

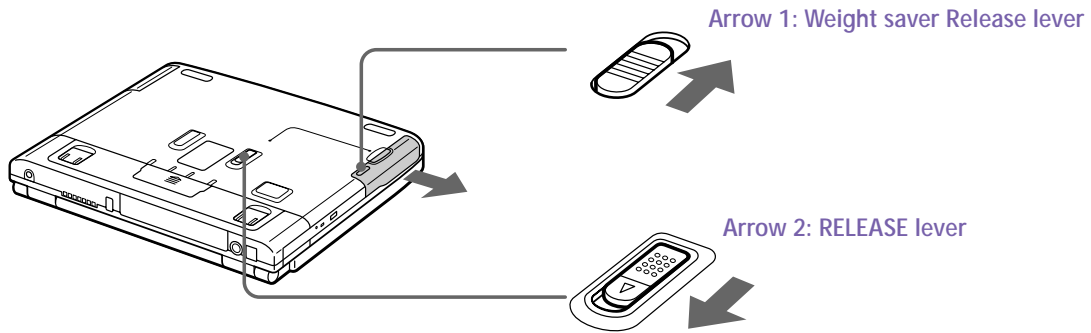

- 2 After removing the weight saver, pull out the weight saver's hinged arm and fold it into the weight saver.

Connecting Peripheral Devices

You can add functionality to your computer by connecting any of these peripherals:

- Phone line (page 42)
- Port replicator (page 43)
- Printer (page 47)
- External display (page 48)
- External mouse or keyboard (page 51)
- External speakers (page 52)
- External microphone (page 53)
- Digital still camera or other serial device (page 54)
- Digital video camera recorder (page 55)
- Universal Serial Bus (USB) device (page 56)



Before you connect peripherals, turn off the computer and all peripherals.

Connect the power cord only after connecting all cables.

Turn on the computer only after turning on all peripherals.

Connecting a Phone Line

You need to connect a phone line to take advantage of online services and the Internet.

 In order to register your Sony VAIO Notebook Computer, register your software online, and use Sony Customer Support, you must connect to a phone line. You must register your computer to receive the extended warranty.

- 1 Plug one end of the phone cable into the phone line jack on the computer.

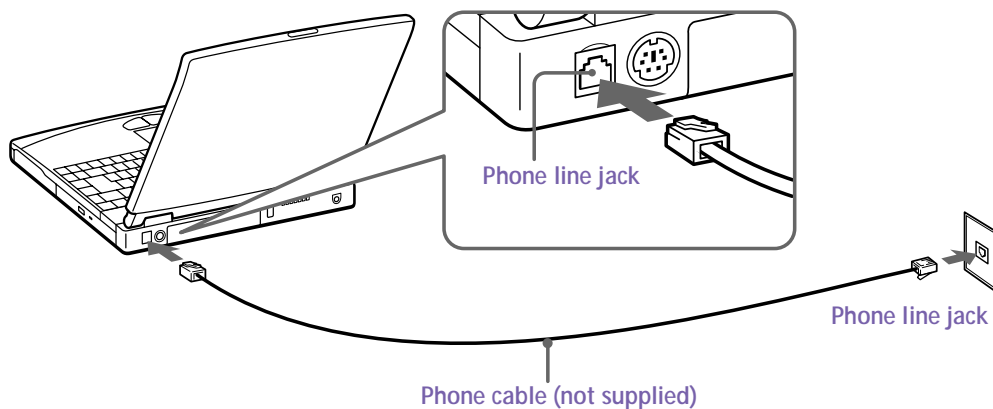

- 2 Plug the other end into the wall jack.

 Your computer does not work with party lines, cannot be connected to a coin-operated telephone, and may not work with multiple phone lines or a private branch exchange (PBX). Some of these connections might result in excess electrical current and could cause a malfunction in the internal modem.

Connecting the Port Replicator

Your notebook computer supports the use of an optional port replicator. Attaching a port replicator enables you to connect additional peripherals to your computer.

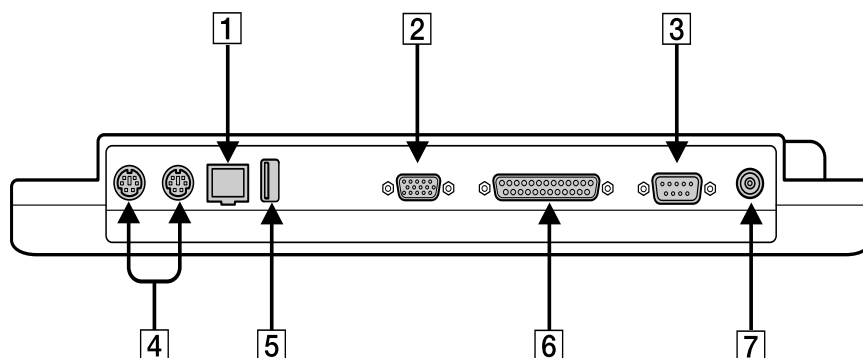

1  Network (Ethernet)

2  Monitor (page 48)

3  Serial (page 54)

4  Mouse/Keyboard (page 51)

5  USB (page 56)

6  Printer (page 47)

7  DC In (page 9)

 The port replicator can be powered only with an AC power adapter. Do not remove the AC adapter from the port replicator or the AC outlet while using the port replicator; this may cause data damage or hardware malfunctions.

When using the port replicator for the first time, install the driver supplied with the port replicator. When installation is complete, a message appears asking if you want to change the system setup. Click Yes, then reboot your computer.

To attach your computer to the port replicator

To supply power to your computer while it is connected to the port replicator, you can connect the AC adapter directly to the port replicator.

 When attaching your computer to the port replicator, do not attempt to insert or remove the battery pack. Lifting and turning the computer with an attached port replicator could cause a temporary loss of power.

- 1 Turn off your computer and disconnect all peripherals.
- 2 On the bottom of the computer, lift the port replicator connector cover.

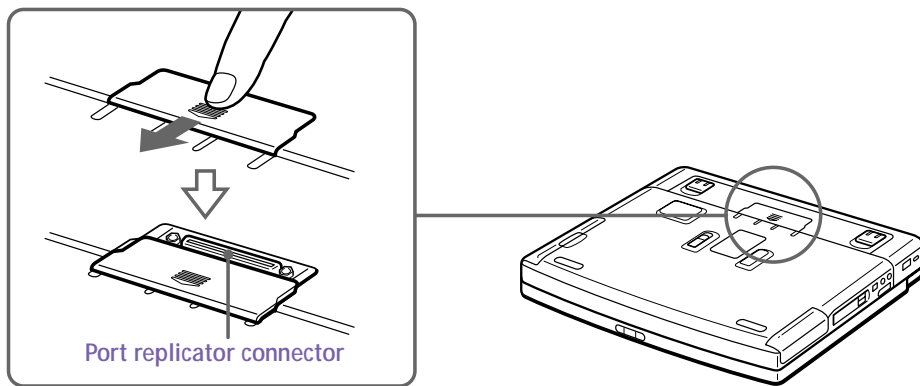

- 3 Attach the bottom of the computer to the port replicator until it clicks.

Notebook computer

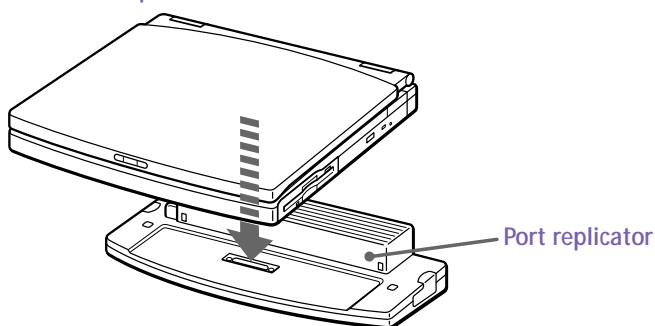

- 4 Plug the cable attached to the AC adapter into the DC IN connector on the port replicator. Plug the power cord into the AC adapter and an AC outlet.

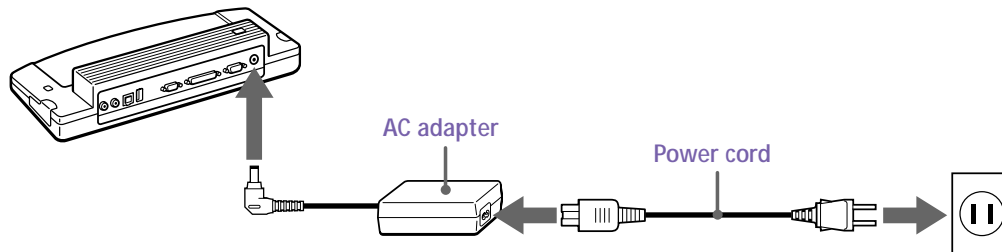

 Use the AC adapter that comes with your computer or the optional Sony PCGA-AC71 adapter.

The ① power indicator light turns green.

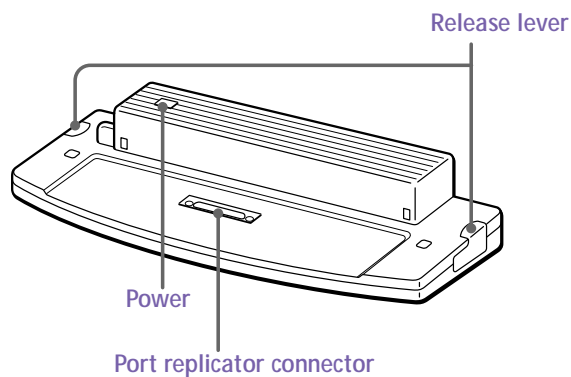

- 5 Turn on the computer.

To remove your computer from the port replicator when the power is off

- 1 Turn off your computer and the connected peripherals.
- 2 Pull the levers on each side of the port replicator to disengage the computer from the port replicator.

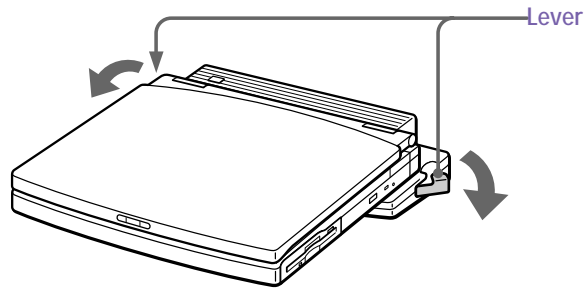

- 3 Lift the computer away from the port replicator.

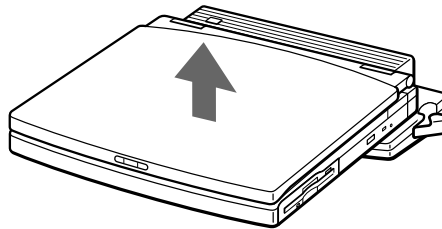

- 4 Close the port replicator connector cover on the bottom of your computer.



It is extremely important to close the port replicator connector cover after removing your computer from the port replicator. If the cover is left open, dirt may get inside and damage the computer.

Connecting a Printer

You can connect a Windows 98-compatible printer to your computer to print documents.

To connect a printer

- Use the  symbol to locate the Printer connector. Plug the printer cable (supplied with the printer) into this port on the computer.

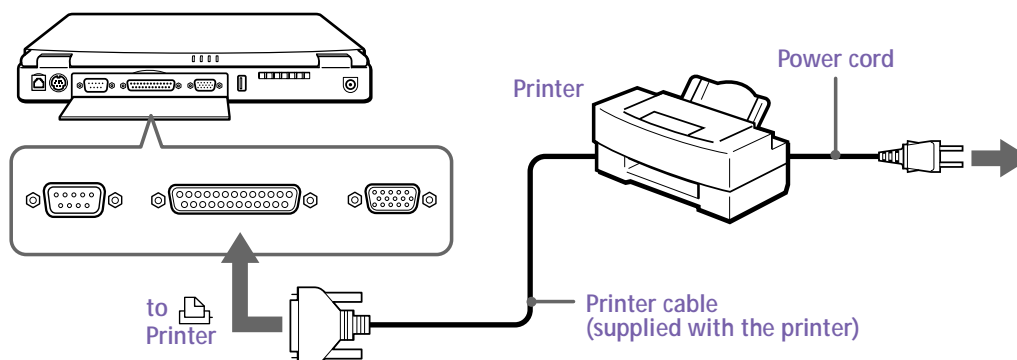

 See the manual that came with your printer for more information on installation and use.

Before using the printer, you may need to change the Printer setting in the Sony Notebook Setup software. See "Displaying the Sony Notebook Setup Screen" on page 57.

Connecting an External Display

You can connect an external display to your notebook computer. For example, you can use the computer with any of the following:

- ❑ Computer display (monitor) (page 48)
- ❑ Multimedia computer display (page 49)
- ❑ Projector (page 50)

To connect a computer display

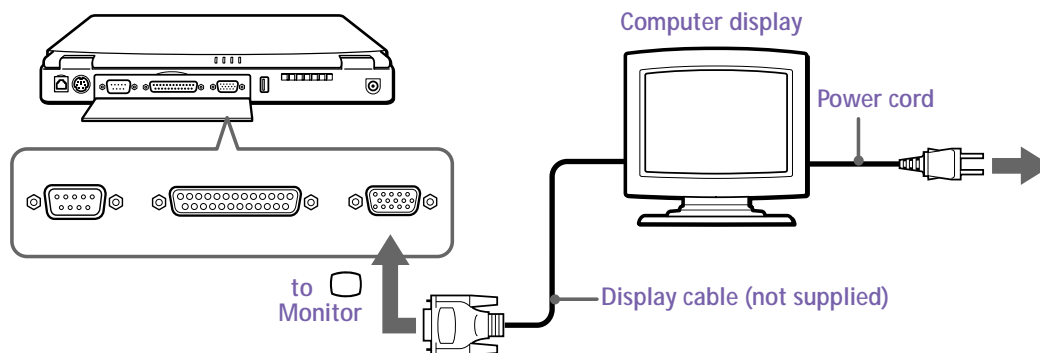

- ❑ Use the  symbol on the back of the computer to locate the Monitor connector. Plug the display cable (not supplied) into this connector on the back of the computer.
- ❑ If necessary, plug one end of the display power cord into the display, and the other end into an AC outlet.



 See the manual that came with your computer display for more information on installation and use.

To connect a multimedia computer display

You can connect the notebook computer to a multimedia computer display that includes built-in speakers and a microphone.

- 1 Use the  symbol to locate the Monitor connector. Plug the display cable into this connector.
- 2 Use the  symbol to locate the Headphone connector. Plug the speaker cable into this connector.
- 3 Use the  symbol to locate the Microphone connector. Plug the microphone cable into this connector.

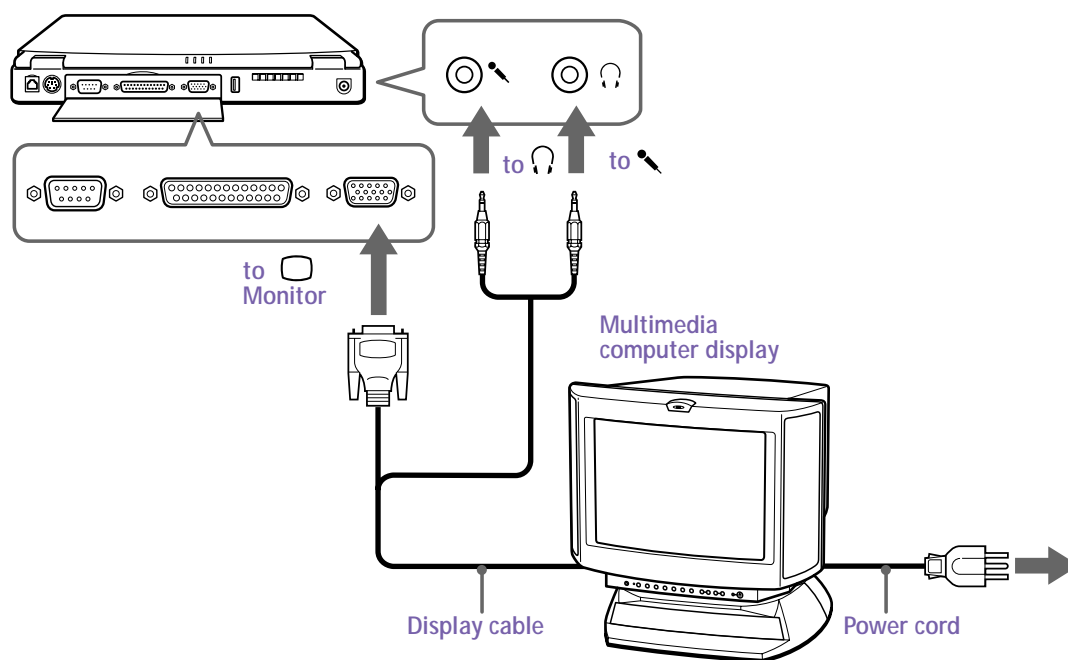

 See the manual that came with your multimedia computer display for more information on installation and use.

To connect a projector

You can use a projector, such as the Sony LCD Projector, as an external display.

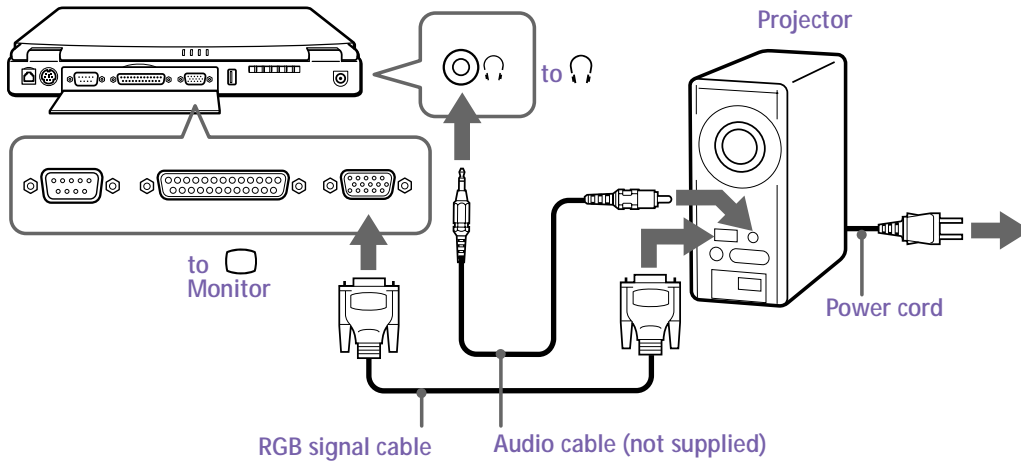

See the manual that came with your projector for more information on installation and use.

To select a display





When you connect an external display to the monitor connector, you can toggle the output among the Liquid Crystal Display (LCD), the external monitor, or both devices.

Use the Fn+F7 keys to select a display. See also “Selecting the Display Mode” on page 65 for more information.



| To | Press | Result |
|-------------------------------|-------|--|
| Switch to an external display | Fn+F7 | Toggles among the LCD, the external display connected to the Monitor connector, and both the LCD and external display. |

Only LCD → LCD and external display → Only external display → Only LCD

Connecting an External Mouse or Keyboard

You can connect an external mouse or keyboard to the computer by plugging the mouse or keyboard into the  /  Mouse/Keyboard connector. To connect both a mouse and keyboard at the same time, you must use the port replicator. Connect the keyboard to the  /  Mouse/Keyboard connector, and the mouse to the  Serial connector of the port replicator. The Mouse/Keyboard connector requires a PS/2[®]-style plug or adapter.

To connect an external mouse or keyboard

- ❑ Use the  /  symbol to locate the Mouse/Keyboard connector. Plug the keyboard cable or mouse cable into this connector with the  mark facing up.

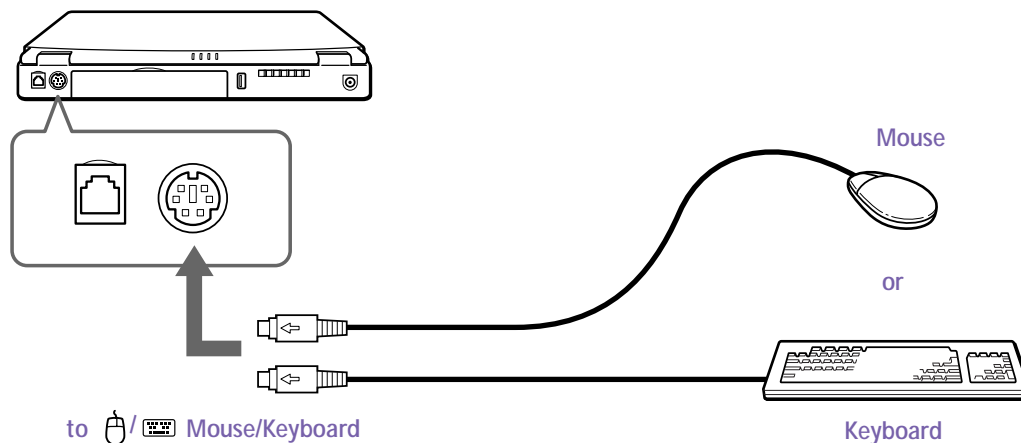

 See "Using the Keyboard" on page 18 for more information on using the keyboard.

See the manual that came with your mouse or keyboard for more information on installation and use.

Before you connect or disconnect the mouse or keyboard, turn off the computer.

Before connecting a mouse to the Serial port, make sure the mouse is compatible with a serial port.

Connecting External Speakers

You can enhance the sound quality of your computer by connecting external speakers.

 Make sure your speakers are designed for computer use.

Turn down the volume of the speakers before you turn them on.

Do not place diskettes on the speakers; the speakers' magnetic field may damage the data on the diskettes.

To connect external speakers

- Use the  symbol to locate the Headphone connector. Plug the speaker cable into this connector.

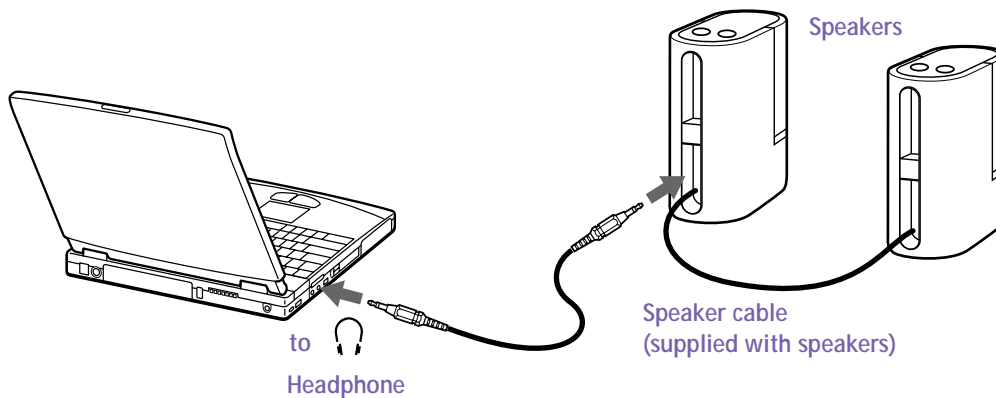

 See the manual that came with your speakers for more information on installation and use.

Connecting an External Microphone

You can enhance the quality of sound input by using an external microphone.

 Make sure your microphone is designed for computer use.

To connect an external microphone

- Use the  to locate the Microphone connector. Plug the microphone cable into this connector.

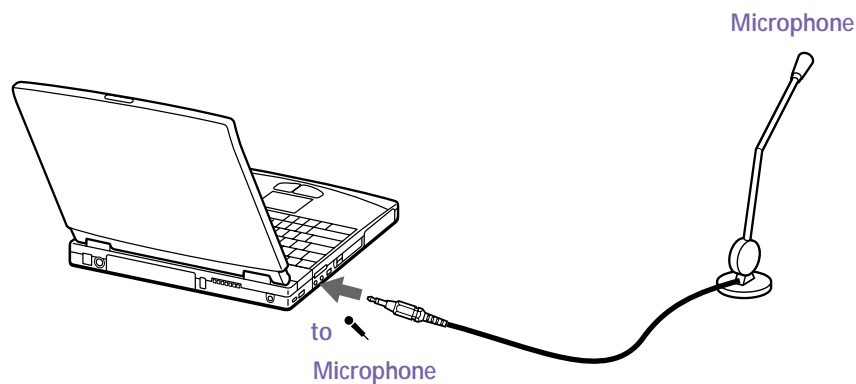

 See the manual that came with your microphone for more information on installation and use.

Connecting a Digital Still Camera or Other Serial Device

You can connect other computer peripherals, such as the Sony Digital Still Camera, to the Serial connector on your computer.

To connect a digital still camera

- ❑ Use the IOIOI symbol to locate the Serial connector. Plug the connecting cable (not supplied) into this port on the computer and into the Digital I/O connector on the digital still camera.

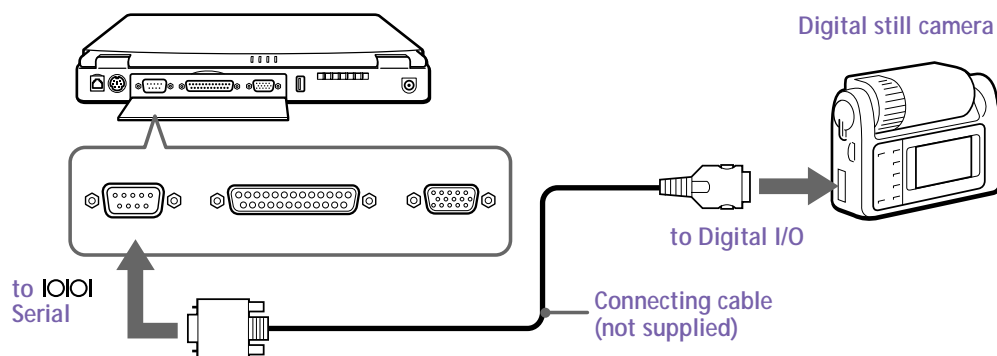

 The Sony Digital Still Camera is pictured; you may need to connect your camera differently.

See the manual that came with your digital camera or other serial device for more information on installation and use.

If you use a digital camera that has an infrared data communication system or other infrared communication device, see "Using Infrared Communication Devices" on page 32.

Connecting a Digital Video Camera Recorder

You can connect a digital video camera recorder to the S200 i.LINK™ i (IEEE 1394) connector.

To connect a digital video camera recorder

- ❑ Plug one end of the i.LINK cable (not supplied) into the i.LINK connector on the left side of the computer and the other end into the DV In/Out connector on the digital video camera recorder.

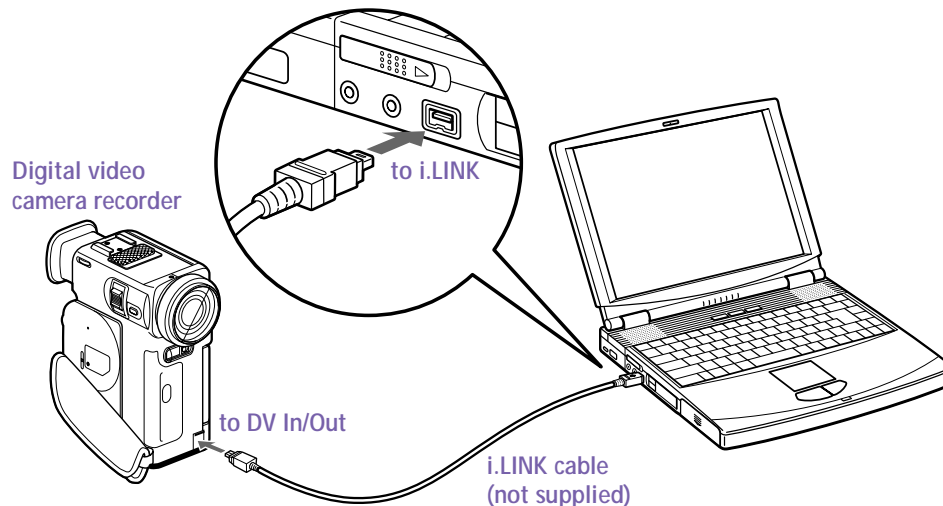

 The Sony digital video camera recorder (DCR-PC7) is pictured; you may need to connect your camera differently.

On Sony digital video cameras, connectors labeled "DV In/Out" or "i.LINK" are i.LINK-compatible.

See the manual that came with your digital video camera recorder for more information on installation and use.

Do not connect more than one digital video camera at a time. The software supplied with your computer will not recognize multiple cameras.

The i.LINK connector on the computer does not supply power to external devices. If the external device requires power from the i.LINK connector, you cannot use the device with the computer.

The computer supports transfer rates up to 200 Mbps; however, the actual transfer rate is the lowest transfer rate of the external device.

The i.LINK features available may vary depending on the software applications you use. See the documentation that came with your software for more information.

Connecting a Universal Serial Bus (USB) Device

You can connect a USB device to your computer.

To connect a USB device

- Use the  symbol to locate the USB connector. Plug one end of the USB cable into this port and the other end into the USB device.

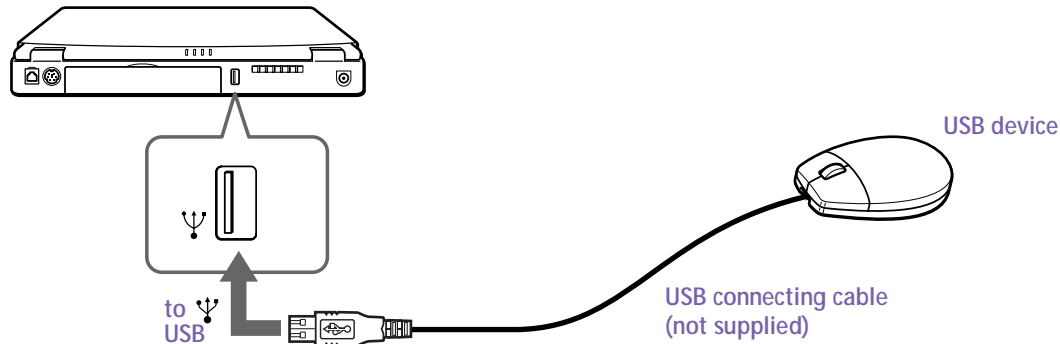

You can use the optional Sony USB mouse PCGA-UMS1 with this computer. The USB mouse software driver is preinstalled in the computer. Therefore you only need to plug the USB mouse into the USB connector.

 See the manual that came with your USB device for more information on installation and use.

Customizing Your Notebook Computer

You can customize the settings of your notebook computer. The following sections briefly describe how to change your computer's default settings. You can also refer to the Sony Notebook Setup Help for more detailed information.

Displaying the Sony Notebook Setup Screen

To display the Sony Notebook Setup screen:

- 1 Click the Start button on the Windows 98 taskbar.
- 2 Point to VAIO and click Sony Notebook Setup.

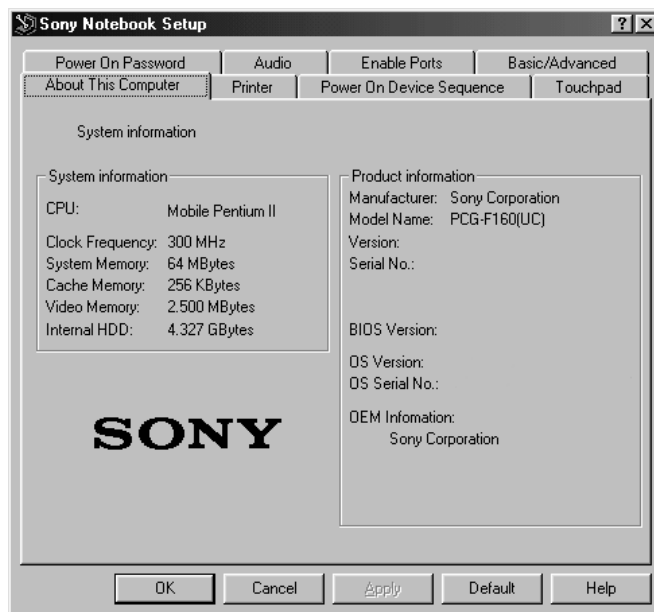

- 3 Select the tab for the item you want to change. See “Notebook Setup Tabs” on page 58.
- 4 After you finish, click OK.

Notebook Setup Tabs

| <i>Tab</i> | <i>Description</i> |
|--------------------------|---|
| About This Computer | Display system information, including memory capacity, serial number, and BIOS version. |
| Audio | Change the volume of the sounds that play while the operating system is loading. |
| Printer | Select printer port mode settings. |
| Power On Device Sequence | Select the order of drives and devices from which you want to load the operating system. You can specify the hard drive as well as other drives inserted into your computer. |
| Touchpad | When you connect an optional mouse to the Serial port of your computer, you can make your touchpad inactive. You can also customize the settings of your mouse using the mouse utility. |
| Power On Password | Set the password to secure your computer. |
| Enable Ports | Change the hardware resources such as I/O address, IRQ, or DMA depending on the optional hardware or software you use. Disabling ports releases resources to the system. To change the serial or infrared settings, click Advanced on the Basic/Advanced tab. |
| Basic/Advanced | Toggle between Advanced mode (additional screens with advanced settings) and Basic mode of display. Advanced mode includes Serial, Infrared, and View Resources tabs. |









For more information about each option, click Help on the Sony Notebook Setup screen to display the Help file.





Controlling Power Management

The PowerPanel utility allows you to control the power management of your notebook computer and provides key information about system activity and battery life. The following sections briefly describe how to conserve your computer's battery power. You can also refer to the PowerPanel Help for more detailed information.

Power Management Profiles





PowerPanel provides several predefined power management profiles. Each profile consists of a group of specific power management settings that are designed to meet specific power management goals—ranging from maximum power management to no power management. You can change the settings for any of the predefined profiles or you can create your own profile to suit your portable computing needs. The predefined profiles are:

| <i>Icon</i> | <i>Description</i> |
|---|--|
|  | Maximum Performance – Provides the best system performance while still conserving power. |
|  | Maximum Battery Life – Provides power saving features to give you maximum battery life and good performance. It slows the computer and puts it into System Suspend mode after a specified time period. |
|  | Disable Power Management – Turns off all power management features such as System Suspend and System Hibernation modes. |
|  | AC Power – The power management state when AC power is in use. Similar to the Power Management Off setting. PowerPanel automatically loads the AC profile unless you disable this feature. |
|  | Games – Disables the display and the Hard Disk Standby timer. |
|  | Presentation – Keeps the display on at all times while it conserves power. This option is ideal for slide show presentations. You can establish settings for LCD (Video) Standby, Hard Disk Standby, and System Suspend to optimize power management for your system. |

| <i>Icon</i> | <i>Description</i> |
|---|--|
|  | Word Processing – Optimizes power management with longer timeouts on the hard disk and display screen. You can also establish settings for LCD (Video) Standby, Hard Disk Standby, and System Suspend to optimize power management for your system. |
|  | Spreadsheet – Optimizes performance and power requirements for spreadsheet applications such as Microsoft Excel. [®] |
|  | Communications – Extends battery life by initiating a quick display timeout. The Internal modem remains powered. You can also establish settings for LCD (Video) Standby, Hard Disk Standby, and System Suspend to optimize power management for your system. |
|  | Automatic Profile Selection – Automatically switches to a profile suitable for active applications. |

Power Management Commands

PowerPanel also provides power management commands that you can use to activate specific power management functions and to control power for a specific device. You might use these commands when you want to override a profile setting or initiate an immediate action, such as putting the system into Video Standby mode before the Video Standby timer expires.

| <i>Icon</i> | <i>Description</i> |
|---|---|
|  | System Idle – Puts the system into Idle mode, a state of low power consumption. This state stops the CPU clock and puts all peripherals into low power mode. To return the system to the active state, press any key or power switch on your system. |
|  | System Suspend – Puts the system into System Suspend mode, a power management state that saves the state of the system and peripheral devices in memory (RAM). Power consumption reduces to a minimum, and the system remains on. To return the system to the active state, press any key or the power switch on your computer. |
|  | System Hibernation – Provides for the lowest level of power consumption. The system writes the state of the system and peripheral devices to the hard disk and turns off the system power. To return the system to the original state, use the power switch to turn on power. The system saves the data in the Save to Disk Partition on the hard drive. |
|  | LCD (Video) Standby – Turns off the LCD to save power. If you turn off the Video Standby timer, the display remains active except when the system enters System Suspend mode. The video display system is one of the largest consumers of power in the system. |

To activate PowerPanel

When you start your computer, the PowerPanel toolbar appears along the right edge of the screen by default. If the toolbar does not appear, right-click the taskbar at the bottom of the screen. Select **Toolbar** from the pop-up menu, then click **PowerPanel**. The PowerPanel appears on the taskbar.



The Current Profile icon appears on the PowerPanel toolbar. To change the profile, click the profile icon, then select a profile from the list of profiles.

To select the power management command, click the power management button you want to set.



Refer to the PowerPanel Help for information on customizing the PowerPanel toolbars.

When you use the battery pack to power your computer, your system selects the Maximum Battery Life power management profile by default. If you select a different power management profile while using battery power, that profile is selected automatically the next time you use the battery pack to power your computer.

To customize the power management settings

You can change the power management settings, such as the system timer and brightness of the screen.

- 1 Click the profile icon on the PowerPanel toolbar.
- 2 Select **Edit Profile** from the menu.
- 3 Click a profile for which you want to change the setting.
- 4 Double-click an item for which you want to change the setting.
- 5 Click a desired setting.
- 6 Click the **File** menu, then click **Save**.
- 7 Click the **File** menu, then click **Close**.

Displaying Battery Information

You can display detailed information for each of the batteries in your computer. The following sections briefly describe how to display your computer's general battery information. You can also refer to the BatteryScope Help for more detailed information.

Activating BatteryScope

To activate BatteryScope

When you start your computer, the BatteryScope toolbar appears along the right edge of the screen by default. If the toolbar does not appear, right-click the taskbar at the bottom of the screen. Select **Toolbar** from the pop-up menu, then click **BatteryScope**. The BatteryScope appears on the taskbar.

You can also view battery gauges on the shared PowerPanel and BatteryScope toolbar.

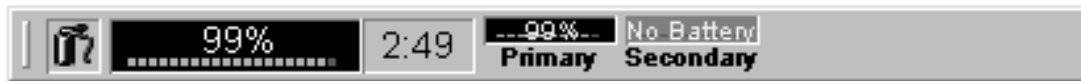





Percentage indicator

Displays the percentage of the remaining capacity.

Time indicator

Displays estimated time (hours/minutes) remaining before the battery fully drains, also referred to as the time-to-empty.

Battery Icon Descriptions

| Battery icon | Battery status |
|---|----------------|
|  | Discharging |
|  | Fully charged |
|  | Charging |
|  | Not in use |
|  | No battery |

Displaying Detailed Battery Information

You can obtain detailed information about the batteries.

- Click the battery icon on the taskbar to display the BatteryScope window.

The screen appears displaying the General tab, which contains information such as the estimated time-to-empty and charging time.

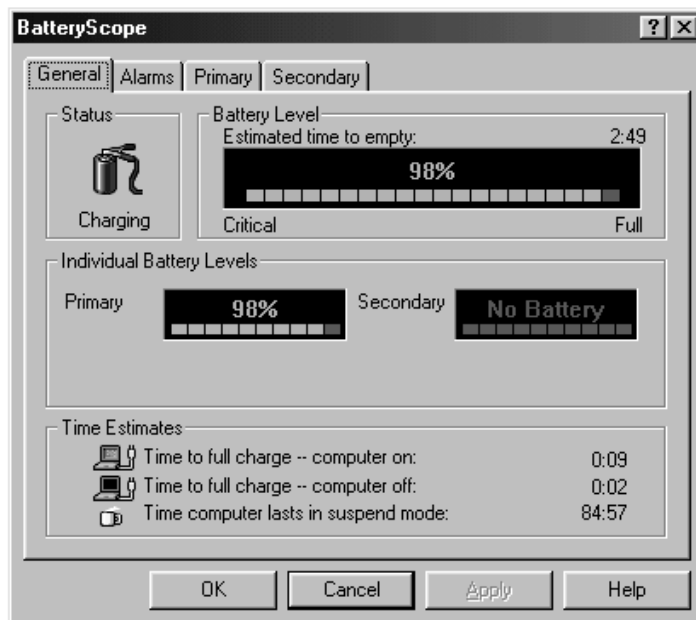

To display information on individual batteries

- 1 Click the Primary battery tab to display information for the battery in the bay on the left side.
- 2 Click the Secondary battery tab to display information for the battery in the bay on the right side.

You can display the information about each battery, such as estimated time-to-empty, manufacturer, capacity, and other information.

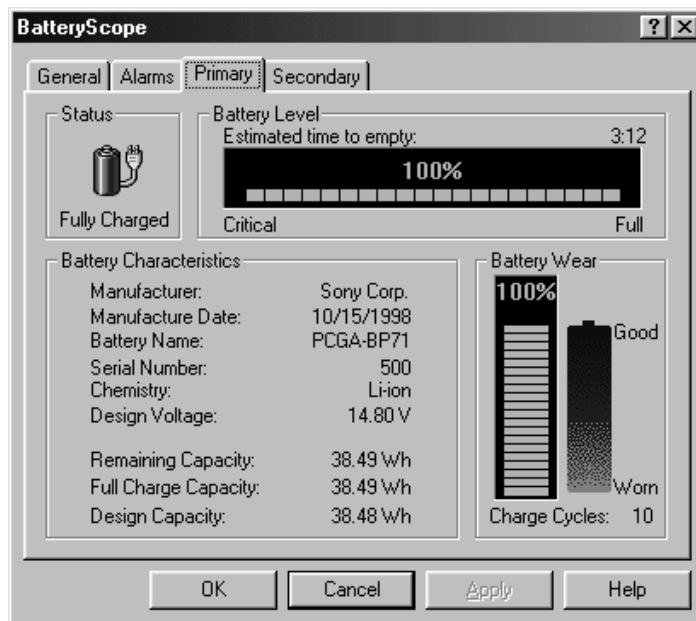

To customize the BatteryScope toolbar and alarm system

You can customize the BatteryScope toolbar to suit your portable computing needs, including modifications to the alarm settings. Refer to the BatteryScope Help for more information.

Selecting the Display Mode

When you connect an external display, you can toggle the display mode between the LCD on your computer and external displays.

- 1 Click the Start button on the Windows 98 taskbar.
- 2 Point to Settings and click Control Panel.
- 3 Click Display.
- 4 Click the Settings tab, then click the Advanced button.
- 5 Click the NeoMagic® tab.

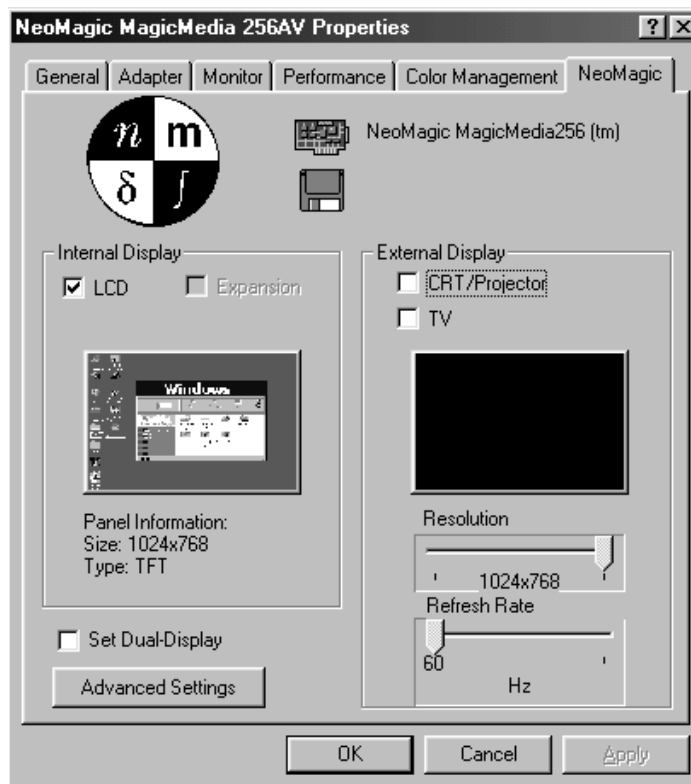

6 Select the type of display:

| | |
|-------------------------------------|--|
| External (CRT/Projector) | Displays an external computer display or RGB connected projector that is connected to the Monitor connector on your computer. |
| Internal (LCD) | Displays the LCD of your computer. |



You can turn off the computer's LCD display by removing the checkmark from the LCD option under Internal Display.

If you select CRT/Projector and turn off the LCD, you can use the Refresh Rate slider to change the display's horizontal frequency. This setting can be made only for CRT display. If you select Independent Display Timing (see page 67), you can change both the resolution and the refresh rate.

7 Click OK. If you have made changes, the System settings change dialog box appears. Select Yes to restart Windows.

8 If you have not made changes, click OK to close the Display Properties screen.



Depending on the types of computer displays and projectors you are using, you may not be able to display the computer's LCD and external display simultaneously.

Using a CRT or Projector

When you select CRT/Projector as the display mode, you can make additional settings, described as follows:

- 1 After selecting CRT/Projector as the type of external display (step 6 on page 66), click Advanced Settings.
- 2 Click the External Display Options tab.
- 3 Select the following options:

External Display Device:

| | |
|-----------|--|
| CRT | Connects with the external computer display. |
| Projector | Connects with the projector. |

Monitor Settings:

| | |
|----------------------------|---|
| Independent Display Timing | Click to place a checkmark when you want to set the resolution and refresh rate differently from the computer's LCD. To change the resolution and refresh rate, see the notes to step 6 on page 66. |
|----------------------------|---|

Projector Settings:

| | |
|------|---|
| Type | Select the projector's resolution from the drop-down box. |
|------|---|

- 4 Click OK.



You cannot select Independent Display Timing when the display is set to True Color (24 bit).

Display Specifications

LCD Display Mode

| <i>Resolution</i> | <i>Number of colors</i> |
|-------------------|--|
| 1024 x 768 | 65,536* (PCG-F150); 16,770,000* (PCG-F160/180/190) |
| 800 x 600 | 16,770,000* |
| 640 x 480 | 16,770,000* |

* Achieved by graphic accelerator's dithering function

External Display Mode

| <i>Resolution</i> | <i>Number of colors</i> |
|-------------------|-------------------------|
| 1280 x 1024 | 256 |
| 1024 x 768 | 16,770,000 |
| 800 x 600 | 16,770,000 |
| 640 x 480 | 16,770,000 |

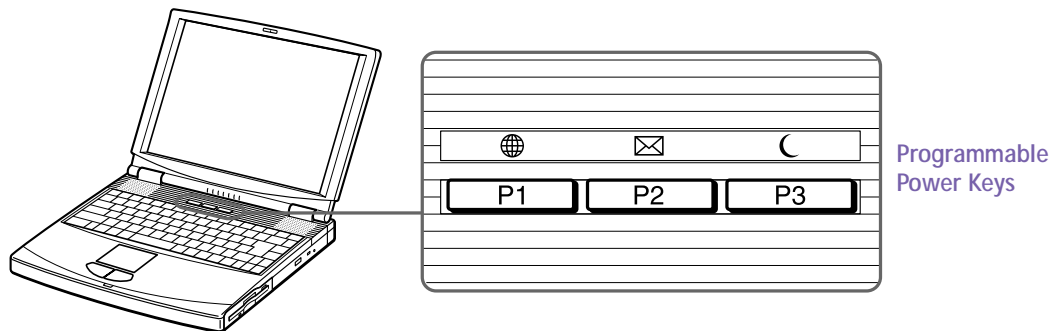

Starting Your Favorite Software with Programmable Power Key (PPK) Setup

The PPK Setup software enables you to start your favorite software by simply pressing the Programmable Power Keys. This section briefly describes how to use the Programmable Power Keys. You can also refer to the PPK Setup Help for more detailed information.



Programmable Power Keys

Your computer has three Programmable Power Keys, which are set to activate as follows by default:

| <i>Press:</i> | <i>To activate:</i> |
|--|----------------------|
| P1  | VAIO demo |
| P2  | The e-mail software |
| P3  | System Suspend mode* |

* When power is off, pressing this key turns your computer on.

To use the PPK Setup window:

- 1 Double-click the PPK Setup icon on the taskbar. The PPK Setup window appears.
- 2 Click a Programmable Power Key tab for the Programmable Power Key you want to use.
- 3 Click the combination of keys you want to use.
- 4 Select "Select from the registered files list," then click Next.
- 5 Select a desired setting, then click OK.
- 6 Click OK.



You can change PPK launch files, select files not currently registered, or disable the PPK. Refer to the PPK Help for more detailed information.

Using the internal Timer:

You can use the internal Timer to start software at a specific time. You can use this feature when the computer is on or in System Suspend mode.

 When selecting software that uses a phone line: The computer may not be able to disconnect the phone line due to communication and server conditions. Be sure to monitor the status of the software when running PPK Setup, and manually disconnect the phone line if you notice a malfunction. Furthermore, when using the Timer to start the software, it is advised that you set the computer to enter System Suspend or System Hibernation mode after a certain time. This allows the computer to disconnect the phone line if the computer fails to disconnect the line normally. However, the computer cannot disconnect the phone line when it enters System Suspend mode if the internal modem ring resume is set to On.

Using the Dual Display Function

The dual display function allows you to distribute portions of your desktop across separate displays. For example, if you have an external monitor attached to the monitor connector, your LCD display and the monitor can function as a single desktop. You can move the cursor off one display and onto the other. This allows you to drag objects, such as an open application window or a toolbar, from one display to the other. This configuration of a single desktop distributed across separate displays is referred to as a virtual desktop.

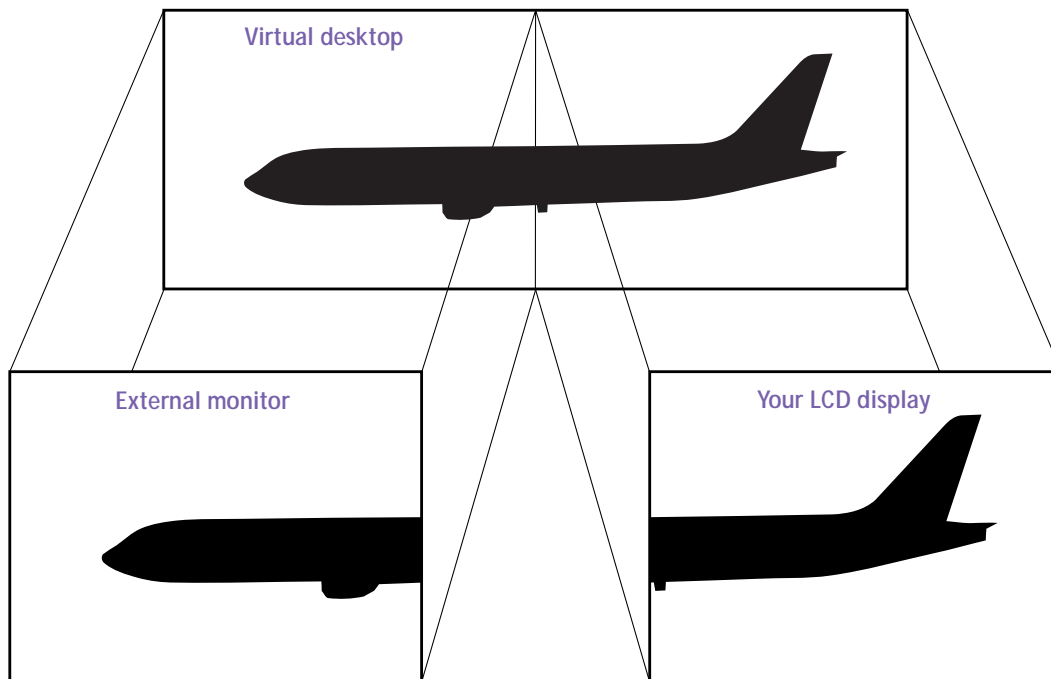

Selecting dual display mode

You must restart Windows to use dual display mode. Save your work and close any open applications before changing to dual display mode, then follow these steps:

- 1 Click the Start button on the Windows 98 taskbar.
- 2 Point to Settings and click Control Panel.
- 3 Click the Display icon.
- 4 Click the Settings tab.
- 5 Click the Advanced button.
- 6 Click the NeoMagic tab.

- 7 Check the Set Dual-Display option and click OK. The System Settings Change dialog box appears.
- 8 Click Yes to restart your system.
- 9 Repeat steps 1 to 3 to display the Display Properties screen.
- 10 Click the display icon number 2.
- 11 Click Yes.
- 12 Click OK.

Setting the colors and resolution for each display

You can set the display colors and resolution for each display that is part of a virtual desktop.

Follow steps 1 to 4 above to display the Display Properties screen. Select the display you wish to change (1 or 2) by clicking on the icon of the display. You can change colors by selecting an option from the Colors list. Use the slider in the Screen area to change the resolution. Click OK or Apply. Click OK to confirm that you want to make the changes.

Customizing the virtual desktop

You can customize dual display mode by changing the position of the two desktops that comprise the virtual desktop.

In the Display Properties screen, drag the icons of display 1 or display 2, moving them to a new position relative to each other. The two display icons must be connected to create a virtual desktop. Click OK to apply the change.

Releasing the dual display setting

You must restart Windows to return to single display mode. Save your work and close any open applications before returning to single display mode. Follow the steps in the section above on Selecting dual display mode. In step 7, remove the check from the Set Dual-Display option. You must restart Windows before the change takes effect.

Getting Help

Sony provides several support options for your Sony computer. When you have questions about your computer and the preinstalled software, check these sources for answers, in the following sequence:

| | | |
|---|---|--|
| 1 | <i>VAIO Notebook Computer Read Me First</i> | Contains a complete list of the items that ship with your computer, product specifications, software support information, and the most up-to-date information on using your computer. |
| 2 | <i>VAIO Notebook Computer User Guide</i> | Explains how to use your notebook computer and connect peripheral devices. |
| 3 | Online User Guide | This electronic version of the <i>User Guide</i> contains additional information on the preinstalled software titles. You can access this guide from the Windows Start menu by selecting Programs/VAIO/Documentation. |
| 4 | Manuals and online help files that may accompany your preinstalled software | Most of the manuals for preinstalled software are located on your hard disk drive as online help files. You can access the online help files from the Help menu in the specific application. A printed manual is available for some applications. |
| 5 | Knowledge Database | Provides instant access to information on commonly encountered problems. Enter a description of your problem and the Knowledge Database searches for the corresponding solutions online. You can access the Sony Knowledge Database at: http://www.sony.com/pcsupport/ |

-
- | | | |
|---|-------------------------------------|--|
| 6 | Sony Fax-on-Demand | This service provides you with answers to commonly asked questions. You can use this automated service to request a list of available topics and then select the topics that you want to receive. To contact the Sony fax-on-demand service, call 1-888-4SONYPC (1-888-476-6972). (Requires a fax machine or your fax software.) |
| 7 | Calling Sony Customer Support | You can call and speak with a Sony Customer Support Representative without using your computer by calling 1-888-4SONYPC (1-888-476-6972). Software support is available free of charge for 90 days after the original date of purchase. |
-

Troubleshooting

This section describes how to solve common problems you may encounter when using your computer. Many problems have simple solutions, so try these suggestions before you call Sony Customer Support.

 When you reconnect devices be sure to turn off the computer as described in “Shutting Down Your Computer” on page 15. Turning off the computer using other methods may result in data loss.

My computer does not start

- Check that the computer is plugged into a power source and that it is turned on. Check that the power indicator on the front panel of the computer indicates that the power is on.
- Check that the battery packs are inserted properly and that they are charged.
- Make sure there is no diskette in the floppy disk drive.
- Confirm that the power cord and all cables are connected firmly, as described in “Connecting Peripheral Devices” on page 41.
- If you plugged the computer into a power strip or UPS, make sure the power strip or UPS is turned on and working.
- If you are using an external display, check that it is plugged into a power source and turned on. Check that the brightness and contrast controls are adjusted correctly. See the manual that came with your display for details.
- Moisture condensation may have occurred. Do not use the computer for at least one hour and then turn on the computer.
- Your computer’s internal backup battery may be low on power. Change the backup battery located on the bottom of your computer, following the procedure in “Replacing the Internal Backup Battery” on page 82.

When I turn on my computer, the message “Operating system not found” appears and Windows does not start

- Check the floppy disk drive to see if a non-bootable diskette is in the drive.
- If a non-bootable diskette is in the drive, turn off the computer, remove the diskette, and then turn on the computer again. Confirm

that Windows starts properly. If Windows still does not start, follow the procedure below to initialize the BIOS.

- ❑ If the floppy disk drive is empty, follow the steps below to initialize the BIOS:
 - 1 Remove any peripheral devices connected to the computer.
 - 2 Turn the computer off and then turn it on again.
 - 3 Turn on the computer and press the F2 key when the Sony logo appears. The BIOS setup menu screen appears.
 - 4 Press the arrow keys to select the Exit menu.
 - 5 Press the arrow keys to select Get Default Values and then press the Enter key. The message “Load default configuration now?” appears.
 - 6 Check that [Yes] is selected, then press the Enter key.
 - 7 Press the arrow keys to select Exit (Save Changes) and then press the Enter key. The message “Save configuration changes and exit now?” appears.
 - 8 Check that [Yes] is selected, then press the Enter key. The computer restarts.

If your computer still displays the message “Operating system not found” and Windows does not start, contact Sony Customer Support.

My LCD does not display anything

- ❑ Check that the computer is plugged into a power source and that it is turned on. Check that the power indicator on the front panel of the computer is on.
- ❑ Check that the battery packs are inserted properly and that they are charged.
- ❑ The computer may be in LCD (Video) Standby mode. Press any key to activate the display.

The screen image on my external display is not centered or sized properly

Use the controls on your external display to adjust the image. See the manual supplied with your display for more information.

My computer “locks up”

- ❑ Try restarting the computer. On the Windows taskbar, click the Start button, click Shut Down, and then click Restart the computer.
- ❑ If you cannot restart as described in the preceding step, you can restart the computer by pressing Ctrl+Alt+Delete.

- ❑ If the previous step does not work, slide the power switch toward the front and hold it for at least four seconds. This turns off the power.
- ❑ If your computer locks up while playing a DVD-ROM/CD-ROM, stop the DVD-ROM/CD-ROM, and restart the computer by pressing Ctrl+Alt+Delete.



Pressing Ctrl+Alt+Delete may result in data loss in files that are currently open.

My software program "locks up" or crashes

Contact the software publisher or designated provider for technical support. See the online version of *Read Me First* for a complete list of phone numbers.

My DVD-ROM drive tray does not open

- ❑ Make sure the computer is turned on.
- ❑ Press the Eject button on the DVD-ROM/CD-ROM drive.
- ❑ If the Eject button does not work, you can open the tray by inserting a sharp, pointed object into the hole to the right of the Eject button.

I cannot play a CD-ROM

- ❑ Make sure the label of the CD-ROM is facing up.
- ❑ If the CD-ROM requires software, make sure the software is installed according to the program's instructions.
- ❑ Moisture condensation may have occurred. Leave the computer for at least 1 hour while the computer is turned on.
- ❑ Clean the CD-ROM.
- ❑ Check the speaker volume.

I cannot play a DVD-ROM

- ❑ If a region code warning appears when you are using the DVD player, it could be that the DVD-ROM you are trying to play is incompatible with the DVD-ROM drive in your notebook computer. The region code is listed on the disc's packaging.
- ❑ If you hear audio but cannot see video, your computer's video resolution may be set too high. For best results, change the Windows Control Panel/Display/Settings to 800 x 600 using 256 colors.

- ❑ If you see video but cannot hear audio, check all of the following: Make sure your DVD player's mute setting is off. Check the master volume setting in the audio Mixer. If you have connected speakers externally, check the volume settings in your computer speakers and check the connections between your speakers and the computer. Check the Windows Control Panel/System/Device Manager to see that the drivers are installed properly.
- ❑ A dirty or damaged disc may cause the computer to "hang" while it tries to read the disc. If necessary, reboot the computer, remove the disc, and then check that it is not dirty or damaged. For cleaning instructions, see "On Cleaning CD-ROMs and DVD-ROMs" on page 90.

When I click an application icon a message appears, such as "You must insert the application CD into your CD-ROM drive," and the software does not start

- ❑ Some titles require specific files that are located on the application's CD-ROM. Insert the disc and try starting the program again.
- ❑ Make sure you place the disc in the tray with the label side facing up.

My floppy disk drive cannot write to a diskette

- ❑ If the diskette is write-protected, disable the write-protect feature or use a diskette that is not write-protected.
- ❑ Check that the diskette is properly inserted into the floppy disk drive.

My speakers have no sound

- ❑ If the built-in speakers are turned off, press Fn+F3 to turn on the speakers.
- ❑ If the speaker volume is turned to the minimum, press Fn+F4, and then press **↑** or **→** to increase the volume.
- ❑ If your computer is powered by batteries, check that the battery packs are inserted properly and that they are charged.
- ❑ If you are using an application that has its own volume control, check that the volume is turned up.
- ❑ Check the volume controls in Windows 98.
- ❑ If you connect external speakers, check that the speakers are properly connected and the volume is turned up. If the speakers have a mute button, make sure it is off. If the speakers are powered by batteries, check that the batteries are inserted properly and that they are charged.

- ❑ If you have connected an audio cable to the Headphone connector, disconnect the cable.

My modem does not work

- ❑ Check that the phone line is plugged into the line jack. See “Connecting a Phone Line” on page 42 for details.
- ❑ Check that the phone line is working. You can check the line by plugging in an ordinary phone and listening for a dial tone.
- ❑ Check that the phone number the program is dialing is correct.
- ❑ Check that the software you are using is compatible with the notebook computer modem. (All preinstalled programs are compatible.) Call the software publisher or Sony Customer Support.

My modem connection is slow

The computer’s modem uses K56flex™ technology and V.90 capability. Many factors influence modem connection speed, including telephone line noise or compatibility with telephone equipment (such as fax machines or other modems). If you think your modem is not connecting properly to other PC-based modems, fax machines, or your Internet Service Provider, check the following:

- ❑ Have your phone company check that your phone line is free from any line noise.
- ❑ If your problem is fax-related, check that there are no problems with the fax machine you are calling and that it is compatible with fax modems.
- ❑ If you are having a problem connecting with your Internet Service Provider, check that the ISP is not experiencing technical problems.
- ❑ If you have a second phone line available, try connecting the modem to that line.

My microphone does not work

If you are using an external microphone, check that the microphone is plugged into the Microphone connector. See “Connecting an External Microphone” on page 53 for details.

My mouse does not work

- ❑ If you are using an external mouse, check that the mouse is plugged into the mouse connector. See “Connecting an External Mouse or Keyboard” on page 51 for details.

- ❑ If you connected an external mouse while your computer is on, you must restart your computer.
- ❑ If you are using an optional Sony USB mouse PCGA-UMS1, check that the mouse is plugged into the USB connector.

My touchpad does not work

You may have disabled the touchpad while no mouse was connected to the computer. If so, you must restart the computer to make the touchpad work again.

I cannot use DV devices. The message "DV equipment seems to be disconnected or turned off" appears.

- ❑ Check that the DV device is turned on and that the cables are properly connected.
- ❑ If you are using multiple i.LINK devices, the combination of the connected devices may cause unstable operation. In this case, turn off the power to all connected devices and disconnect unused devices. Check the connection, then turn on the power again.

My touchpad interprets a single tap as a double-click

Click the Mouse icon in the Control Panel and then change the button assignments in the Mouse Properties dialog box. One of the buttons is assigned to the double-click action.

My computer does not shut down

It is best to shut down your computer using the Shut Down command on the Windows 98 Start menu. Using other methods, including those listed here, may result in loss of unsaved data. If the Shut Down command does not work properly, follow these steps:

- ❑ Restart the computer by pressing Ctrl+Alt+Delete. If this does not work, slide the power switch forward and hold it for at least four seconds to turn off the power.
- ❑ Unplug the computer from the AC adapter and remove the battery pack from your computer.

My PC card is not working

- ❑ Make sure the PC card is compatible with Windows 98.
- ❑ Use the Sony Notebook Setup utility to disable devices you are not currently using.

The sound of my computer's fan is too loud

Use the PowerPanel utility to change the Thermal Control Strategy setting to Quiet. This setting slows down the CPU speed. See the PowerPanel Help for more information.

I cannot print

The default setting for the printer port mode is correct for most printers. If you cannot print, try changing the printer port mode. In Sony Notebook Setup, select the Printer tab. If the printer port mode is set to ECP, change it to bi-directional. If the printer port mode is set to bi-directional, change it to ECP. See “Displaying the Sony Notebook Setup Screen” on page 57 for details on using Sony Notebook Setup.

Replacing the Internal Backup Battery

The backup battery will last about three years. When the battery is low on power, replace it with a Sony lithium battery CR2025 or compatible.

To replace the backup battery

- 1 Turn off the computer and connected devices, then unplug all the cables.
- 2 Unscrew the battery cover to open it.

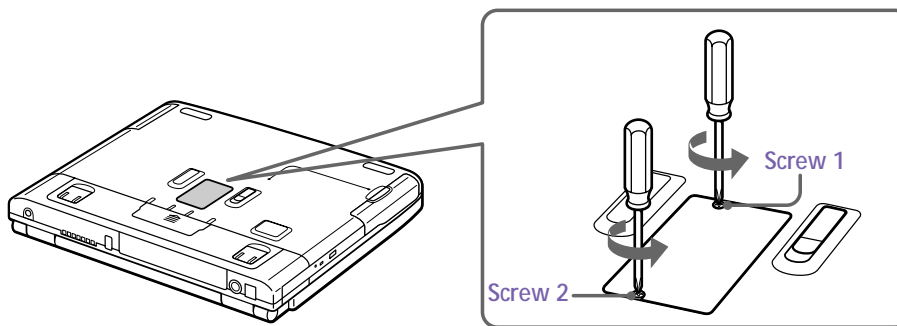

- 3 Remove the battery.

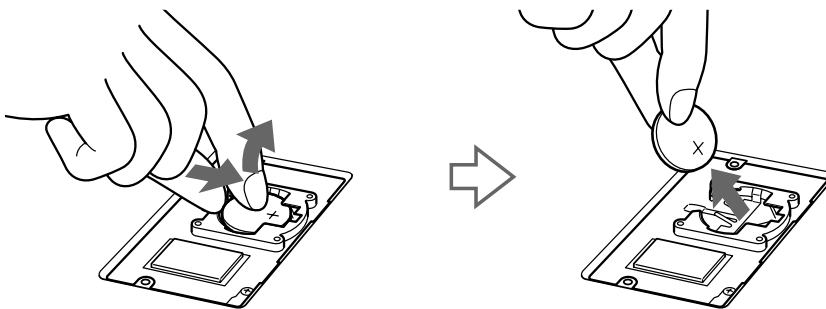

- 4 Insert a new battery and close the cover.

Follow the procedure below to set the clock.

To set date and time

After replacing the backup battery, be sure to set the time as follows:

- 1 Turn on the computer.
The message “Press <F1> to resume, <F2> to Setup” appears at the bottom of the display.
- 2 Press F2.
The BIOS Setup menu starts.

- 3 Set the date (month/day/year).
Press Enter to move to the next item. To enter 01/31/1999, for example, follow these steps: Type 1, press Enter, type 31, press Enter, type 1999, then press Enter.
- 4 Press ↓ to select System Time, then set the time (hour:minute:second).
Press Enter to move to the next item.
- 5 Press → to select Exit, then press ↓ to select Get Default Values.
The message “Load default configuration now?” appears.
- 6 Make sure that Yes is selected and press Enter.
If No is selected, press ← to select Yes.
- 7 Select Exit (Save Changes), then press Enter.
The message “Save configuration changes and exit now?” appears.
- 8 Make sure that Yes is selected and press Enter.
The computer restarts.

Using the System and Application Recovery CDs

The following sections describe how to use the System Recovery and Application Recovery utilities.

Using the System Recovery CD(s)

You can reinstall software titles that shipped with your computer if they are corrupted or accidentally erased. You may not need to recover the entire contents of your hard drive. If you experience a problem with your computer, reinstalling an individual device driver or software title may correct the problem. Use the Application Recovery CD(s) to reinstall individual applications or device drivers. See “Using the Application Recovery CD(s)” on page 86.

The System Recovery CD contains a backup copy of all the software originally installed on your hard disk drive. **It can be used only to recover the hard disk of the notebook computer you purchased.**

The System Recovery utility gives you three options:

- ❑ **Full Restore without Format** restores all the software titles that originally came with your computer without formatting the hard disk.
- ❑ **Full Restore with Format** formats the hard disk drive and then restores all the original software.
- ❑ **Operating System Only** restores the Windows 98 operating system, the notebook computer utility programs, and the device drivers that shipped with your computer.

! If you choose the Full Restore with Format or Operating System Only option, your hard disk will be formatted, which removes all the information on the hard disk drive. You will lose any software you have installed and any other files you have created since you started to use your computer. This means you will have to reinstall any applications that were not included with the computer when you purchased it. If you choose the Full Restore without Format option, you may need to reinstall applications that were not included with the computer when you purchased it. If you have any questions on using the System Recovery CD, contact Sony Customer Support.

To use the System Recovery CD(s)

 You need to complete the Windows 98 registration process when you use the System Recovery CD. Make sure you have the product ID number located on the cover of your Microsoft Windows 98 "Getting Started" manual. You will need this number to complete the recovery process.

- 1 Insert the Sony System Recovery CD in the DVD-ROM/CD-ROM drive.**

 The System recovery utility boots from the DVD-ROM/CD-ROM drive. It must be in the DVD-ROM/CD-ROM drive when you turn on the computer.

- 2 Shut down your computer as described in "Shutting Down Your Computer" on page 15.**
- 3 Wait four seconds and turn on your computer.**
- 4 Click OK to signify you have read and accept the Microsoft End-User License Agreement.**
- 5 When the System Recovery menu appears, follow the on-screen instructions to complete the recovery process.**

 Your system may include one or two System Recovery CDs. If you have two System Recovery CDs, insert the first CD to run the System Recovery program. You are prompted to insert the second CD once the information from the first CD has been installed.

The recovery process takes from 30 to 60 minutes to complete.

If your computer does not start from the Recovery CD

- 1 Slide the power switch forward and hold it for more than four seconds to turn off the computer.**
- 2 Turn on the computer. When the Sony logo is displayed, press the F2 key. The BIOS setup menu screen appears.**
- 3 Press the arrow keys to select the Exit menu.**
- 4 Press the arrow keys to select Get Default Values and then press the Enter key. The message "Load default configuration now?" appears.**
- 5 Check that [Yes] is selected, then press the Enter key.**
- 6 Press the arrow keys to select Exit (Save Changes) and then press the Enter key. The message "Save configuration changes and exit now?" appears.**

- 7 Check that [Yes] is selected, then press the Enter key. The computer restarts from the Recovery CD.

Using the Application Recovery CD(s)

The Application Recovery CD(s) allows you to reinstall individual applications and device drivers if they are corrupted or accidentally erased. Reinstalling an individual device driver or software title may correct a problem you are experiencing with your computer, and you may not need to recover the entire contents of your hard drive. If you do need to reinstall all the software titles that shipped with your computer, use the System Recovery CD(s). See “Using the System Recovery CD(s)” on page 84.

You can also use the Application Recovery CD to install Windows NT[®] Workstation 4.0 drivers on your computer.



You must be in Windows to run the Application Recovery CD. The application will not run from DOS. If you have any questions on using the Application Recovery CD, contact Sony Customer Support.

To use the Application Recovery CD(s)

- 1 Turn on your computer. If your computer is already on, close all applications.
- 2 When the Windows desktop appears, insert the Sony Application Recovery CD in the DVD-ROM/CD-ROM drive. The Application Recovery utility loads automatically.
- 3 When the Application Recovery menu appears, select the icon for the application you want to restore and then follow the on-screen instructions to complete the recovery process.



Your system may include one or two Application Recovery CDs. If you have two Application Recovery CDs, insert the first CD to run the Application Recovery program. You may be prompted to insert the second CD, depending on the application you wish to restore.

For a list of the contents of the Application Recovery CD(s), see the online version of *Read Me First*.

Notes on Use

This section describes safety guidelines and precautions to help protect your computer from potential damage.

On Handling the LCD Screen

- ❑ Do not leave the LCD facing the sun as it can damage the LCD. Be careful when using the computer near a window.
- ❑ Do not scratch the LCD or exert pressure on it. This could cause malfunction.
- ❑ Using the computer in low temperature conditions may produce a residual image on the screen. This is not a malfunction. When the computer returns to normal temperature, the screen returns to normal.
- ❑ A residual image may appear on the screen if the same image is displayed for a lengthy period of time. The residual image disappears in a while. You can use a screen saver to prevent residual images.
- ❑ The screen becomes warm during operation. This is normal and does not indicate a malfunction.
- ❑ The LCD is manufactured using high-precision technology. You may, however, see tiny black points and/or bright points (red, blue, or green) that continuously appear on the LCD. This is a normal result of the manufacturing process and does not indicate a malfunction.

On the Power Source

- ❑ Your computer operates on 100V-240V AC 50/60 Hz.
- ❑ Do not share the AC outlet with other power-consuming equipment, such as a copy machine or shredder.
- ❑ You can purchase a power strip with a surge protector. This device prevents damage to your computer caused by sudden power surges such as those that may occur during an electrical storm.
- ❑ Do not place heavy objects on the power cord.

- ❑ To disconnect the cord, pull it out by the plug. Never pull the cord itself.
- ❑ Unplug your computer from the wall outlet if you will not be using the computer for a long time.
- ❑ When the AC adapter is not used, unplug it from the AC outlet.
- ❑ Use only the AC adapter supplied. Do not use any other AC adapter.

On Handling

- ❑ Clean the cabinet with a soft, dry cloth or a soft cloth lightly moistened with a mild detergent solution. Do not use any type of abrasive pad, scouring powder, or solvent such as alcohol or benzine, as these may damage the finish of your computer.
- ❑ Should any solid object or liquid fall into the computer, shut down your computer and then unplug it. You may want to have the computer checked by qualified personnel before operating it any further.
- ❑ Do not drop the computer or place heavy objects on top of the computer.

On Installation

- ❑ Do not place your computer in a location subject to:
 - ❑ Heat sources, such as radiators or air ducts
 - ❑ Direct sunlight
 - ❑ Excessive dust
 - ❑ Moisture or rain
 - ❑ Mechanical vibration or shock
 - ❑ Strong magnets or speakers that are not magnetically shielded
 - ❑ Ambient temperature of more than 95° F (35° C) or less than 50° F (10° C)
 - ❑ High humidity
- ❑ Do not place electronic equipment near your computer. The computer's electromagnetic field may cause a malfunction.
- ❑ Provide adequate air circulation to prevent internal heat buildup. Do not place your computer on porous surfaces such as rugs or blankets, or near materials such as curtains or draperies that may block its ventilation slots. Leave a space of at least 8 inches behind the back panel of the computer.

- ❑ The computer uses high-frequency radio signals and may cause interference to radio or TV reception. Should this occur, relocate the computer a suitable distance away from the set.
- ❑ Use only specified peripheral equipment and interface cables; otherwise, problems may result.
- ❑ Do not use cut or damaged connection cables.
- ❑ Your computer will not work with party lines, cannot be connected to a coin-operated telephone, and may not work with multiple phone lines or a private branch exchange (PBX).
- ❑ If the telephone company makes a service call to your home or office and determines that your computer is responsible for a problem, the telephone company may bill you for the service call. Also, if you do not disconnect your computer when it is adversely affecting the telephone line, the telephone company has the right to disconnect your service until you correct the problem.

On Moisture Condensation

If the computer is brought directly from a cold location to a warm one, moisture may condense inside your computer. In this case, allow at least an hour before turning on your computer. If any problems occur, unplug your computer, and contact your Sony Service Center.

On Handling Diskettes

- ❑ Do not open the shutter manually and touch the surface of the diskette.
- ❑ Keep diskettes away from magnets.
- ❑ Keep diskettes away from direct sunlight and other heat sources.

On Handling CD-ROMs and DVD-ROMs

- ❑ Do not touch the surface of the disc.
- ❑ Do not drop or bend the disc.

On Cleaning CD-ROMs and DVD-ROMs

- ❑ Fingerprints and dust on the surface of a disc may cause read errors. Proper care of the disc is essential to maintain its reliability. Do not use solvents such as benzine, thinner, commercially available cleaners or anti-static spray, as they may cause damage to the disc.
- ❑ For normal cleaning, hold the disc by its edge and use a soft cloth to wipe the surface from the center out.
- ❑ If the disc is badly soiled, moisten a soft cloth with water, wring it out well, and use it to wipe the surface of the disc from the center out. Wipe off any remaining moisture with a dry soft cloth.

On Using Batteries

- ❑ Never leave the battery pack in temperatures above 140° F (60° C), such as under direct sunlight or in a car parked in the sun.
- ❑ Battery life is shorter in a cold environment. This is due to decreased battery efficiency at low temperatures.
- ❑ Charge the batteries at temperatures between 50° F and 80° F (10° C to 30° C). Lower temperatures require a longer charging time.
- ❑ While the battery is in use or being discharged, the battery pack heats up. This is normal and is not cause for concern.
- ❑ Keep the battery pack away from all sources of heat.
- ❑ Keep the battery pack dry.
- ❑ Do not open or try to disassemble the battery pack.
- ❑ Do not expose the battery pack to any mechanical shock.
- ❑ If you are not using the computer for an extended period of time, remove the battery pack from the computer to prevent damage to the battery.
- ❑ If, after fully charging the battery pack, the battery power is still low, the battery pack may be reaching the end of its life and should be replaced.
- ❑ You do not need to discharge the battery before recharging.
- ❑ If you have not used the battery pack for a considerable amount of time, recharge the battery.

On Maintenance

- ❑ Make sure to disconnect the power cord before cleaning the computer.
- ❑ Avoid rubbing the LCD screen as this can damage the screen. Use a soft, dry cloth to wipe the LCD screen.
- ❑ Clean the computer with a soft cloth lightly moistened with a mild detergent solution. Do not use any type of abrasive pad, scouring powder or solvent, such as alcohol or benzine.

Adding Memory

In the future, you may want to install memory modules to expand the functionality of your computer. You can increase memory to 192 MB (160 MB if you purchased model PCG-F150) by installing optional memory modules. To upgrade memory, contact your nearest Sony Authorized Service Center. For the location of a service center near you, call 1-888-4SONYPC.

Limited Warranty Statement

Notebook Computer Warranty

The limited warranty on your VAIO Notebook computer covers parts and labor against defects in material or workmanship for a period of three months from the original date of purchase. You can extend the warranty period for an additional nine months by registering your computer. See “Registering Your Computer” on page 17. Once you register your computer, the limited warranty period is twelve months from the original date of purchase.

There is a separate warranty for the battery included with your computer. See “Battery Limited Warranty” on page 97.

For the purpose of this Limited Warranty “SONY” means SONY ELECTRONICS INC. for Products purchased in the United States of America and Sony of Canada Ltd. for Products purchased in Canada. SONY warrants this computer hardware product (“the Product”) against defects in material or workmanship as follows:

1. Labor: For a period of ninety (90) calendar days from the original date of purchase from SONY or a SONY authorized reseller, SONY will repair defects in material or workmanship in the Product at no charge, or pay the associated labor charges to a SONY authorized personal computer service facility. The ninety (90) day warranty period is extendible only to the original purchaser, for an additional period of nine (9) months, for a total of twelve (12) months from date of purchase when the Product is registered electronically prior to the expiry of ninety (90) days from the original date of purchase. After the applicable period you must pay for all labor charges.

2. Parts: For a period of ninety (90) calendar days from the original date of purchase from SONY or a SONY authorized reseller, SONY will supply, at no charge, new or rebuilt, at SONY’s option, replacement parts in exchange for defective parts. Any replacement parts will be warranted for the remainder of the original warranty period or ninety (90) calendar days from installation by SONY’s authorized personal computer service facility, whichever is longer. The ninety (90) day warranty period is extendible only to the original purchaser, for an additional period of nine (9) months, for a total of twelve (12) months from date of purchase when the Product is registered electronically prior to the expiry of ninety (90) days from the original date of purchase. All defective parts replaced under this Limited Warranty will become the property of SONY.

This Limited Warranty covers only the hardware components packaged with the Product. It does not cover technical assistance for hardware or software usage and it does not cover any software products whether or not contained in the Product; SONY excludes all warranties express or implied in respect of any software provided with the product and any such software is provided “AS IS” unless expressly provided for in any enclosed software limited warranty. Please refer to the End User License Agreements included with the Product for your rights and obligations with respect to the software.

This Limited Warranty is non-transferable. Proof of purchase in the form of a bill of sale (which is evidence that the Product is within the warranty period) must be presented to obtain warranty service. In addition, if replacement parts are required and you wish to receive the most expedient service available, you will be required to provide SONY with a credit card authorization to bill your credit card in the event you fail to return the original parts in the postage-paid envelope we provide. The credit card will only be charged for SONY's list price for the part if the original part has not been returned within thirty (30) days.

In respect of certain components you may be entitled to express warranty service during the warranty period, subject to certain restrictions. Please contact SONY as indicated below for further information.

With respect to all service provided, it is your responsibility prior to Product service to backup the contents of your hard drive, including any data you have stored or software you have installed on the hard drive. It is likely that the contents of your hard drive will be lost or reformatted in the course of service and SONY will not be responsible for any damage to or loss of any programs, data or other information stored on any media or any part of any Product serviced hereunder or any consequential damages resulting therefrom.

IF DURING THE REPAIR OF THE PRODUCT THE CONTENTS OF THE HARD DRIVE ARE ALTERED, DELETED, OR IN ANY WAY MODIFIED, SONY IS NOT RESPONSIBLE WHATSOEVER. YOUR PRODUCT WILL BE RETURNED TO YOU CONFIGURED AS ORIGINALLY PURCHASED (SUBJECT TO AVAILABILITY OF SOFTWARE).

Be sure to remove all third party hardware, software, features, parts, options, alterations, and attachments not warranted by SONY prior to sending the Product to SONY for service. SONY is not liable for any loss or damage to these items.

This Limited Warranty does not cover any consumable items (such as batteries) supplied with this Product; cosmetic damages; damage or loss to any software programs, data, or removable storage media; or damage due to (1) acts of God, accident, misuse, abuse, negligence, commercial use or modifications of this Product; (2) improper operation or maintenance of this Product; (3) connection to improper voltage supply; or (4) attempted repair by any party other than a SONY authorized personal computer service facility. This Limited Warranty does not apply when the malfunction results from the use of this Product in conjunction with accessories, products or ancillary or peripheral equipment, or where it is determined by SONY that there is no fault with this Product itself. This Limited Warranty is valid only in the United States of America and Canada. This Limited Warranty is invalid if the factory applied serial number has been altered or removed from the Product.

Repair or replacement of defective parts or hardware as provided under this Limited Warranty is the exclusive remedy of the consumer. SONY SHALL NOT BE LIABLE FOR ANY INCIDENTAL OR CONSEQUENTIAL DAMAGES OR OTHER DAMAGES INCLUDING BUT NOT LIMITED TO, LOSS OF PROFITS, LOSS OF REVENUE, LOSS OF DATA, LOSS OF USE OF THE PRODUCT OR ANY ASSOCIATED EQUIPMENT, DOWN TIME AND PURCHASER'S TIME. FOR BREACH OF ANY EXPRESS OR IMPLIED WARRANTY, BREACH OF CONTRACT, NEGLIGENCE, STRICT LIABILITY OR ANY OTHER LEGAL THEORY RELATED TO THIS PRODUCT. EXCEPT TO THE EXTENT PROHIBITED BY APPLICABLE LAW, ANY IMPLIED WARRANTY OF MERCHANTABILITY OR FITNESS FOR A PARTICULAR PURPOSE ON THIS PRODUCT IS LIMITED IN DURATION TO THE DURATION OF THIS WARRANTY.

Some states or provinces do not allow the exclusion or limitation of incidental or consequential damages, or allow limitations on how long an implied warranty lasts, so the above limitations or exclusions may not apply to you. This Limited Warranty gives you specific legal rights, and you may have other rights which vary from state to state, or province to province.

Technical Support: Although technical support is not provided free of charge under this Limited Warranty, SONY has established a telephone number for technical support. Charges may apply for technical support, unless and to the extent that free technical support for a limited period is provided in writing as a feature of your Product. Prior to placing your call, please have available the model and serial number for your Product, date of purchase, a list of all options installed in your Product and a detailed description of the problem.

For Product support, online knowledge base, frequently asked questions, and free updates via the Internet: <http://www.sony.com/pcsupport/>

For Product information, service assistance, resolution of a service problem, or technical assistance, call: 1-888-4SONYPC (476-6972).

Save this for future reference.

© 1998 Sony Electronics Inc. and Sony of Canada Ltd. Reproduction in whole or in part without written permission is prohibited. All rights reserved. SONY is a registered trademark of Sony.

GARANTIE RESTREINTE

SONY DU CANADA LTÉE ("SONY") garantit comme suit ce Produit d'ordinateur ("le Produit") contre tous vices de matières premières et de fabrication :

1. Main-d'oeuvre : Pendant une période de quatre-vingt-dix (90) jours à compter de la date d'achat originale chez SONY ou chez un de ses revendeurs autorisés, SONY réparera le Produit à ses frais ou en remboursera les frais de main-d'oeuvre au centre de réparation d'ordinateur personnel autorisé SONY. La période de garantie de quatre-vingt-dix (90) jours peut être prolongée au bénéfice de l'acheteur original pour une période additionnelle de neuf (9) mois, soit un total de douze (12) mois à compter de la date d'achat, lorsque le Produit est enregistré électroniquement. Après la période applicable, l'acheteur doit payer tous les frais de main-d'oeuvre.

2. Pièces : Pendant une période de quatre-vingt-dix (90) jours à compter de la date d'achat originale chez SONY ou chez un de ses revendeurs autorisés, SONY fournira à ses frais des pièces de rechange neuves ou reconstruites, à sa discrétion, en échange des pièces défectueuses. Ces pièces de remplacement seront garanties pour le reste de la période originale de garantie ou pour quatre-vingt-dix (90) jours à compter de leur installation par un centre de service d'ordinateur personnel autorisé SONY, au plus long des deux termes. La période de garantie de quatre-vingt-dix (90) jours peut être prolongée au bénéfice de l'acheteur original pour une période additionnelle de neuf (9) mois, soit un total de douze (12) mois à compter de la date d'achat, lorsque le Produit est enregistré électroniquement. Toutes les pièces défectueuses remplacées au titre de cette garantie restreinte deviennent la propriété de SONY.

Cette garantie restreinte couvre uniquement les composants physiques emballés avec le Produit. Elle n'inclut pas l'assistance technique en rapport avec l'utilisation du matériel ou du logiciel et ne couvre aucun logiciel, qu'il soit ou non fourni avec le Produit. Les logiciels sont fournis "TELS QUELS" à moins d'être expressément couverts par une autre garantie restreinte spécifique. Veuillez vous reporter aux Contrats de licence d'utilisation accompagnant le Produit quant à vos obligations en rapport avec les logiciels.

Cette garantie restreinte est incessible.

Pour vous prévaloir du service au titre de la garantie, vous devrez présenter une preuve d'achat sous forme de facture de vente attestant que le Produit est couvert par la garantie en vigueur. Par ailleurs, si des pièces doivent être remplacées et que vous désirez obtenir le service le plus rapide possible, vous devrez fournir à SONY une autorisation lui permettant d'en porter le montant à votre carte de crédit advenant que vous négligiez de retourner les pièces originales dans l'enveloppe affranchie qui vous est fournie. Seul le prix courant de SONY pour cette pièce sera porté à votre carte de crédit si la pièce ne lui est pas retournée dans un délai de trente (30) jours.

Vous pouvez avoir droit au service de garantie exprès durant la période de garantie, sous réserve de certaines restrictions. Pour tout renseignement, veuillez communiquer avec SONY de la façon indiquée ci-après.

Vous avez l'entière responsabilité de faire une copie de sauvegarde du contenu du disque dur, incluant toute donnée en mémoire ou tout logiciel que vous y avez installé. Il est fort probable que le contenu du disque dur sera reformaté ou perdu en cours de service et SONY ne pourra être tenue responsable d'aucun dommage ni de la perte des programmes, des données ou de toute autre information gardée en mémoire sur tout support d'information ou sur toute partie de tout Produit en réparation.

SI, DURANT LA RÉPARATION DU PRODUIT, LE CONTENU DU DISQUE DUR EST ALTÉRÉ, SUPPRIMÉ OU MODIFIÉ, SONY N'EN SERA AUCUNEMENT RESPONSABLE. LE PRODUIT VOUS SERA RETOURNÉ TEL QU'IL ÉTAIT CONFIGURÉ QUAND VOUS L'AVEZ ACHETÉ (SOUS RÉSERVE DE LA DISPONIBILITÉ DU LOGICIEL).

Avant d'envoyer le Produit à SONY pour le faire réparer, assurez-vous d'en retirer tous produits de tierce partie, logiciels, caractéristiques, pièces, options, altérations et accessoires non garantis par SONY car SONY n'est pas responsable de la perte ou de l'endommagement de ces articles.

Cette garantie restreinte exclut les articles consommables (comme les batteries) fournis avec le Produit ; les dommages cosmétiques ; l'endommagement ou la perte des logiciels, données et supports informatiques amovibles ; les dommages dus à 1) un cas fortuit, un accident, une mauvaise utilisation, un abus, une négligence, une utilisation commerciale ou une modification du Produit ; 2) l'utilisation ou l'entretien incorrect du Produit ; 3) le branchement à une source électrique non conforme ; ou 4) toute tentative de réparation par tout autre qu'un centre de service d'ordinateur personnel autorisé SONY. Cette garantie restreinte ne s'applique pas si la défectuosité est causée par l'utilisation du Produit en conjonction avec des accessoires, articles ou équipements périphériques ou connexes, ou si SONY détermine que le Produit lui-même ne comporte aucun défaut. Cette garantie restreinte n'est valide qu'au Canada.

Cette garantie restreinte est nulle si le numéro de série appliqué en usine a été modifié ou enlevé du Produit.

La réparation ou le remplacement du matériel ou des pièces défectueuses tel que prévu au titre de cette garantie est le seul recours de l'acheteur. SONY NE SÉRA AUCUNEMENT RESPONSABLE DE TOUT DOMMAGE INDIRECT OU CONSÉCUTIF POUR DÉROGATION À TOUTE GARANTIE EXPRESSE OU TACITE, RUPTURE DE CONTRAT, NÉGLIGENCE, RESPONSABILITÉ STRICTE OU TOUTE AUTRE THÉORIE JURIDIQUE EN RAPPORT AVEC CE PRODUIT. DE TELS DOMMAGES INCLUENT, ENTRE AUTRES, LE TEMPS DE L'ACHETEUR, LA PERTE DE PRODUCTIVITÉ, DE REVENUS ET DE PROFITS, ET LA PERTE DE DONNÉES OU D'UTILISATION DU PRODUIT OU DE TOUT ÉQUIPEMENT CONNEXE. SAUF DANS LA LIMITE OÙ LA LOI APPLICABLE L'INTERDIT, TOUTE GARANTIE TACITE DE VALEUR MARCHANDE OU DE CONVENANCE À UNE FIN PARTICULIÈRE DE CE PRODUIT EST RESTREINTE DANS SA DURÉE À LA DURÉE DE CETTE GARANTIE.

Certaines provinces ne permettent pas l'exclusion ou la restriction des dommages accidentels ou indirects et n'admettent pas de limites quant à la durée d'une garantie tacite, de sorte que les exclusions/restrictions exprimées ci-dessus peuvent ne pas s'appliquer. Cette garantie vous donne des droits spécifiques et vous pouvez en avoir d'autres qui varient selon la province.

Soutien technique : Bien que le soutien technique ne soit pas offert gratuitement au titre de cette garantie restreinte, SONY a prévu une ligne téléphonique à cet effet. Des frais peuvent être exigés à moins que le soutien technique gratuit et temporaire ne soit expressément indiqué par écrit comme caractéristique de votre Produit. Avant de placer l'appel, assurez-vous d'avoir les numéros de modèle et de série du Produit, la date d'achat, la liste des options qui y sont installées et une description détaillée du problème.

Vous trouverez sur l'Internet un appui direct, une base de renseignements, une foire aux questions et des mises à jour gratuites sous <http://www.sony.com/pcsupport/>

Pour de l'information sur les produits, de l'aide avec le service, la résolution de problèmes de service ou pour une aide technique, veuillez composer le 1-888-4SONYPC (476-6972).

À conserver pour référence future.

©1998 Sony du Canada Ltée. Reproduction partielle ou complète interdite sans autorisation écrite préalable. Tous droits réservés. SONY est une marque déposée de Sony.

Battery Limited Warranty

The limited warranty on the battery included with your Sony VAIO Notebook Computer covers defects in material or workmanship for a period of 30 days from the original date of purchase. This warranty is not extendible.

For the purposes of this Limited Warranty, "SONY" means Sony Electronics Inc. for Products purchased in the United States of America and Sony of Canada Ltd. for Products purchased in Canada. Sony warrants this Product against defects in material or workmanship for thirty (30) days from your purchase date. If this Product is determined to be defective, SONY will replace the Product at no charge to you. This Limited Warranty contains your exclusive remedy. SONY shall not be liable for any incidental or consequential damages for breach of any express or implied warranty on this product. Some states and provinces do not allow the exclusion or limitation of incidental or consequential damages, so the above limitation or exclusion may not apply to you. This warranty gives you specific legal rights which vary from state to state or province to province. For information on obtaining warranty service, please call SONY at 1-888-4SONYPC (1-888-476-6972).

GARANTIE RESTREINTE

Au titre de cette garantie restreinte, "SONY" signifie Sony du Canada Ltée pour les produits achetés au Canada et Sony Electronics Inc. pour les produits achetés aux États-Unis. SONY garantit ce produit contre tous vices de matières premières et de fabrication pour trente (30) jours à compter de la date d'achat. Si ce produit est reconnu défectueux, SONY le remplacera à ses frais. Cette garantie restreinte est votre seul recours. SONY ne sera aucunement responsable de tout dommage indirect ou consécutif pour dérogation à toute garantie tacite ou expresse sur ce produit. Certaines provinces ne permettent pas l'exclusion ou la restriction des dommages accidentels ou indirects, de sorte que les exclusions/restrictions exprimées ci-dessus peuvent ne pas s'appliquer. Cette garantie vous donne des droits spécifiques et vous pouvez en avoir d'autres qui varient selon la province. Pour de l'information sur le service au titre de la garantie, veuillez appeler Sony au 1-888-4SONYPC (1-888-476-6972).

Index

A

- About This Computer tab 58
- AC adapter 5, 9
- AC power 9
- AC Profile power setting 59
- accessing online support 16
- adding
 - hardware 41
 - memory 92
 - peripherals 41
 - printers 47
- adjusting
 - brightness 14, 22
 - contrast 22
- air circulation 88
- Alt key 19
- Application Recovery CD 86
- Applications key 19
- attaching port replicator 44
- Audio tab 58

B

- Basic/Advanced tab 58
- battery packs 5, 10, 90
 - charge status icons 63
 - charging 11, 37
 - indicator light status 11
 - indicator lights 5, 11, 21, 36
 - inserting 10
 - inserting into battery bay 10
 - loading 10
 - power status 11
 - rechargeable 9
 - removing 12, 36, 37
- BatteryScope utility 62, 64

brightness

- adjusting 14, 22
- built-in speakers 5
 - See also speakers 22
- buttons
 - Eject 27, 28
 - Finish 16
 - left 5
 - right 5
 - Start (Windows 98) 15, 57

C

- cables
 - phone 5
 - power cord 9
- cameras
 - digital video recorder 55
 - Sony Digital Still 54
- canceling commands 19
- Caps Lock 5
 - indicator light 21
- CD-ROM/DVD-ROM discs
 - cleaning 90
 - ejecting 28
 - handling 89, 90
 - inserting 27
 - troubleshooting 77
- CD-ROM/DVD-ROM drive
 - closing tray 28
 - opening tray 27
 - using 27
- charge status indicator light 11
- charging battery packs 11, 37
- choosing
 - power source 10

- cleaning computer 88
 - coin-operated telephones 42
 - computer 73
 - cleaning 88
 - condensation 89
 - customizing 57
 - lithium ion battery v
 - setting up 5
 - setup screen 57
 - starting 14
 - troubleshooting 75, 76, 77
 - connecting
 - coin-operated telephones 42
 - digital still camera 54
 - digital video recorder 55
 - external keyboard 43, 51
 - external mouse 51
 - external speakers 52
 - hard drives 29
 - keyboard 51
 - microphone 53
 - monitor 43, 48
 - mouse 43
 - multimedia computer display 49
 - multiple phone lines 42
 - network 29, 43
 - party phone lines 42
 - PBX 42
 - phone line 42
 - port replicator 43, 44
 - power source 9
 - printer 47
 - projector 50
 - serial device 54
 - USB device 56
 - weight saver 38
 - connectors
 - DC In 9, 43
 - headphone 6
 - i.LINK 6
 - infrared 32
 - keyboard 5, 7, 43
 - Line In 6
 - microphone 6
 - monitor 43
 - mouse 7, 43
 - network 43
 - Printer 7, 47
 - printer 47
 - Serial port 43
 - USB 7, 43
 - contrast
 - adjusting 22
 - correction keys 18, 19
 - Ctrl key 19
 - cursor-movement keys 19
 - customer assistance
 - support options 73
 - customizing your computer 57
- D**
- DC In 9, 43
 - digital still camera 32
 - connecting 54
 - digital video camera 55
 - disconnecting port replicator 46
 - diskettes
 - ejecting 25
 - handling 89
 - inserting into drive 25
 - troubleshooting 78
 - display
 - dual display 71
 - mode 65
 - options 50
 - See also monitor
 - selecting 50
 - disposal of lithium ion battery v
 - drives
 - floppy disk 5
 - installing additional hard disk 29
 - dual display function 71
 - DV In/Out 55
 - DVD-ROM drive tray
 - troubleshooting 77
 - DVD-ROM/CD-ROM discs
 - troubleshooting 77
- E**
- Eject button 25, 27, 28
 - ejecting
 - battery packs 37

- CD-ROM/DVD-ROM discs 28
- diskettes 25
- weight saver 39
- electronic
 - documentation 73
- Enable Ports tab 58
- ergonomic considerations 2, 3
- Escape key 18
- Express Service technical support 17
- external devices
 - display 3, 50
 - See also monitor
 - keyboard 51
 - mouse 51
 - speakers 22, 52
- F**
- faxes
 - laws governing v
- Finish button 16
- floppy disk drive 5
 - cable 5
 - disconnecting 26
 - troubleshooting 78
- Fn 23
- Fn key 19
 - combination commands 22
- function keys 18, 19
- G**
- glare 2
- H**
- handling
 - audio CDs 90
 - CD-ROM/DVD-ROM discs 89, 90
 - diskettes 89
- hard drives
 - indicator light 5, 21
 - installing additional 29
- hardware
 - online support 73
- headphone 5
 - connector 6
- headphones 49
- Help
 - Mouseware 24
 - help 73
- I**
- i.LINK 6, 55
- IEEE 1394 55
- indicator lights 21
 - battery 5, 11, 21, 36
 - Caps Lock 5, 21
 - charge status 11
 - hard drive 5, 21
 - Num Lock 5, 21
 - power 5
 - Scroll Lock 5, 21
- infrared communication devices 32
 - other computers 32
- infrared port 32
- infrared transmission
 - active distance 33
 - troubleshooting 33
- input devices iv
- Insert key 19
- inserting
 - battery pack 10
 - CD-ROM/DVD-ROM discs 27
 - diskettes into drive 25
- installing
 - hard drives 29
 - hardware 41
 - memory 92
 - peripherals 41
- interference iv, 88
- internal microphone 7
- internal speakers
 - See speakers
- K**
- Kensington Security Cable Lock 6
- keyboard 19, 43
 - connecting 51
 - connector 5, 7, 51
- L**
- LCD 87
 - lock lever 14
 - reducing glare 2

- selecting to display output 50
 - troubleshooting 76
 - left button 5
 - lever
 - LCD 14
 - weight saver release 37
 - lighting 2
 - Limited Warranty 93
 - Limited Warranty card 17
 - Line In 6
 - Liquid Crystal Display screen
 - See LCD
 - lithium ion battery
 - disposal v
 - safety precautions v
 - loading
 - battery pack 10
 - location for computer 2
 - lock 6
- M**
- maintenance 88, 91
 - Maximum Battery Life power setting 59
 - Maximum Performance power setting 59
 - memory module
 - installing 92
 - microphone 6
 - connecting 53
 - connector 49
 - internal 7
 - troubleshooting 79
 - modem
 - laws governing v
 - troubleshooting 79
 - moisture condensation 89
 - monitor 7, 43
 - connecting 48
 - connector 49
 - selecting 50
 - switching among 22
 - mouse
 - connecting 51
 - connector 7
 - troubleshooting 79
 - Mouse Properties screen 24
 - Mouseware
 - accessing help 24
 - features 24
 - multimedia computer display 49
 - multiple phone lines 42
- N**
- navigation keys 18, 19
 - network
 - connecting 29
 - connector 43
 - port replicator 43
 - Notebook Computer 5
 - Notebook Setup tabs 58
 - Num Lock 5
 - indicator light 21
 - numeric keypad area 18
- O**
- online
 - help 73
 - opening
 - CD-ROM/DVD-ROM drive tray 27
 - operator keys 19
 - output devices iv
 - adding 47
- P**
- party phone lines 42
 - PBX 42
 - PC card
 - inserting 29
 - release button 29
 - removing 31
 - slot protector 30
 - slots 29
 - troubleshooting 81
 - Type III 29
 - phone
 - cable 5
 - connecting line 42
 - jack 42
 - laws governing v
 - port replicator

- connecting 43, 44
 - disconnecting 46
 - lever 46
 - network 43
 - power 21
 - cord 9
 - indicator light 5
 - switch 6, 14
 - power management
 - settings 59
 - Power Management Off power setting 59
 - Power On
 - Device Sequence tab 58
 - Password tab 58
 - power saving modes 34
 - System Hibernation 22, 35
 - System Idle 23, 34
 - System Suspend 35
 - Video Standby 23
 - power setting
 - AC Profile 59
 - Maximum Battery Life 59
 - Maximum Performance 59
 - Power Management Off 59
 - System Hibernation 60
 - System Suspend 60
 - Video Standby 60
 - power sources 10, 87
 - connecting 9
 - PowerPanel
 - activating 61
 - customizing toolbar 59, 60
 - precautions 88
 - Print Screen key 19
 - printer 7
 - connecting 43, 47
 - connector 47
 - port 47
 - Printer connector 7, 43, 47
 - Printer tab 58
 - projector 50
- R**
- radio interference iv, 88
 - rechargeable battery packs 9, 10
 - recharging battery packs 11
 - Recovery CD 86
 - registering
 - Windows 98 16
 - your computer 17
 - regulatory information iii
 - removing
 - battery packs 12
 - diskettes 25
 - floppy disk drive 26
 - replacing
 - battery packs 36
 - restoring data 86
 - right button 5
- S**
- screen
 - See LCD
 - Scroll Lock 5
 - indicator light 21
 - second battery pack 10, 36
 - selecting
 - display 50
 - LCD 50
 - monitor 50
 - power source 10
 - Serial connector 43, 54
 - serial devices
 - connecting 54
 - digital still camera 54
 - setting up
 - Windows 98 16
 - setting up your PC
 - support 73
 - setup screen
 - About This Computer tab 58
 - Audio tab 58
 - Basic/Advanced tab 58
 - displaying 57
 - Enable Ports tab 58
 - Power On Device Sequence tab 58
 - Power On Password tab 58
 - Printer tab 58
 - Touchpad tab 58
 - setup tabs 58
 - Shift key 19

Shut Down Windows dialog box 15
Sony Customer Support 74
Sony Fax-on-Demand service 74
Sony Notebook Setup screen 57
speakers 5

- built-in 5
- external 52
- switching 22
- troubleshooting 78
- volume 22

Start button 15, 57
starting

- computer 14

startup problems 15
switching

- display 22
- monitor 22

System Hibernation mode 22, 35, 60
System Idle mode 23, 34
System Suspend mode 22, 35, 60

T

technical support

- support options 73

touchpad 5, 24
Touchpad tab 58
troubleshooting 75

- startup 15, 75

turning on

- computer 14

TV

- interference iv, 88

U

USB

- connecting 56
- connector 7, 43, 56
- mouse 56

V

ventilation 88
video camera 55
Video Standby mode 23

W

warranty 17, 93

weight saver

- attaching 36
- connecting 38
- fold-out arm 38
- removing 39

Windows 98

- Certificate of Authenticity 16
- Control Panel 33
- Explorer 20
- Find window 20
- Finish button 16
- help 20
- key 19
- key combinations 20
- License Agreement 16
- registering 16
- setup 16
- Setup Wizard screen 16
- Start button 15
- taskbar 15, 76