

SONY.

VAIO® Notebook Computer User Guide

PCG-F430/PCG-F450



Notice to Users

© 1999 Sony Electronics Inc. All rights reserved. This manual and the software described herein, in whole or in part, may not be reproduced, translated, or reduced to any machine-readable form without prior written approval.

SONY ELECTRONICS INC. PROVIDES NO WARRANTY WITH REGARD TO THIS MANUAL, THE SOFTWARE, OR OTHER INFORMATION CONTAINED HEREIN AND HEREBY EXPRESSLY DISCLAIMS ANY IMPLIED WARRANTIES OF MERCHANTABILITY OR FITNESS FOR ANY PARTICULAR PURPOSE WITH REGARD TO THIS MANUAL, THE SOFTWARE, OR SUCH OTHER INFORMATION. IN NO EVENT SHALL SONY ELECTRONICS INC. BE LIABLE FOR ANY INCIDENTAL, CONSEQUENTIAL, OR SPECIAL DAMAGES, WHETHER BASED ON TORT, CONTRACT, OR OTHERWISE, ARISING OUT OF OR IN CONNECTION WITH THIS MANUAL, THE SOFTWARE, OR OTHER INFORMATION CONTAINED HEREIN OR THE USE THEREOF.

Sony Electronics Inc. reserves the right to make any modification to this manual or the information contained herein at any time without notice. The software described herein is governed by the terms of a separate user license agreement.

This product contains software owned by Sony and licensed by third parties. Use of such software is subject to the terms and conditions of license agreements enclosed with this product. Some of the software may not be transported or used outside the United States. Software specifications are subject to change without notice and may not necessarily be identical to current retail versions.

Updates and additions to software may require an additional charge. Subscriptions to online service providers may require a fee and credit card information. Financial

services may require prior arrangements with participating financial institutions.

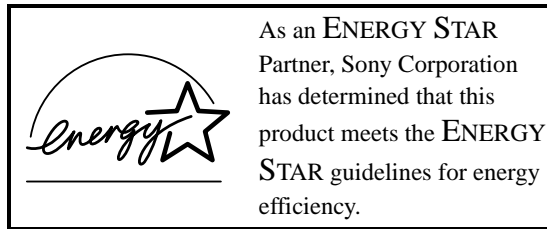

The International ENERGY STAR Office Equipment Program is an international program that promotes energy saving through the use of computers and other office equipment. The program backs the development and dissemination of products with functions that effectively reduce energy consumption. It is an open system in which business proprietors can participate voluntarily. The targeted products are office equipment such as computers, displays, printers, facsimiles and copiers. Their standards and logos are uniform among participating nations. ENERGY STAR is a U.S. registered mark.

Sony, i.LINK, Memory Stick, VAIO and the VAIO logo are trademarks of Sony Corporation. Windows, Windows NT, and the Windows 98 logo are registered trademarks of Microsoft Corporation. Intel and Pentium are trademarks of Intel Corporation.

This product incorporates copyright protection technology that is protected by method claims of certain U.S. patents and other intellectual property rights owned by Macrovision Corporation and other rights owners. Use of this copyright protection technology must be authorized by Macrovision Corporation, and is intended for home and other limited viewing uses only unless otherwise authorized by Macrovision Corporation. Reverse engineering or disassembly is prohibited.

All other trademarks are trademarks of their respective owners.

Owner's Record

The model number and serial number are located on the bottom of your Sony VAIO® Notebook. Record the serial number in the space provided here. Refer to the model and serial number when you call your Sony Service Center.

Model Number: PCG-F430/PCG-F450

Serial Number: _____

Safety Information

WARNING

- To prevent fire or shock hazard, do not expose your notebook computer to rain or moisture.
- To avoid electrical shock, do not open the cabinet. Refer servicing to qualified personnel only.
- Never install modem or telephone wiring during a lightning storm.
- Never install telephone jacks in wet locations unless the jack is specifically designed for wet locations.
- Never touch uninsulated telephone wire or terminals unless the telephone line has been disconnected at the network interface.
- Use caution when installing or modifying telephone lines.
- Avoid using the modem during an electrical storm.
- Do not use the modem or a telephone to report a gas leak in the vicinity of the leak.
- A socket outlet should be as close as possible to the unit and easily accessible.

! To change the backup battery, please contact your nearest Sony Service Center.

! For DVD-ROM: As the laser beam used in the DVD-ROM drive is harmful to the eyes, do not attempt to disassemble the drive cabinet. Refer servicing to qualified personnel only.

AVERTISSEMENT

- Pour prévenir tout risque d'incendie ou d'électrocution, garder cet appareil à l'abri de la pluie et de l'humidité.
- Pour prévenir tout risque d'électrocution, ne pas ouvrir le châssis de cet appareil et ne confier son entretien qu'à une personne qualifiée.
- L'appareil doit être le plus près possible d'une prise murale pour en faciliter l'accès.

Regulatory Information.

Declaration of Conformity

Trade Name: SONY

Model No: PCG-F430/PCG-F450

Responsible Party:
Sony Electronics Inc.

Address:
1 Sony Drive
Park Ridge, NJ 07656

Telephone No.: 201-930-6970

This device complies with Part 15 of the FCC rules. Operation is subject to the following two conditions: (1) This device may not cause harmful interference, and (2) this device must accept any interference received, including interference that may cause undesired operation.

This equipment has been tested and found to comply with the limits for a Class B digital device, pursuant to Part 15 of the Rules. These limits are designed to provide reasonable protection against harmful interference in a residential installation. This equipment generates, uses, and can radiate radio frequency energy and, if not installed and used in accordance with the instructions, may cause harmful interference to radio communications. However, there is no guarantee that interference will not occur in a particular installation. If this equipment does cause harmful interference to radio or television reception, which can be determined by turning the equipment off and on, the user is encouraged to try to correct the interference by one or more of the following measures:

- Reorient or relocate the receiving antenna.
- Increase the separation between the equipment and the receiver.
- Connect the equipment into an outlet on a circuit different from that to which the receiver is connected.
- Consult the dealer or an experienced radio/TV technician for help.

You are cautioned that any changes or modifications not expressly approved in this manual could void your authority to operate this equipment.

Only peripherals (computer input/output devices, terminals, printers, etc.) that comply with FCC Class B limits may be attached to this computer product. Operation with noncompliant peripherals is likely to result in interference to radio and television reception.

All cables used to connect peripherals must be shielded and grounded. Operation with cables, connected to peripherals, that are not shielded and grounded, may result in interference to radio and television reception.

FCC Part 68

This equipment complies with Part 68 of the FCC rules. On the bottom of this equipment is a label that contains, among other information, the FCC equivalence number (REN) for this equipment. If requested, this information must be provided to the telephone company.

This modem uses the USOC RJ-11 telephone jack.

The REN is used to determine the quantity of devices which may be connected to the telephone line. Excessive RENs on the telephone line may result in the devices not ringing in response to an incoming call. In most, but not all areas, the sum of the RENs should not exceed five (5.0). To be certain of the number of devices that may be connected to the line, as determined by the total RENs, contact the telephone company to determine the maximum REN for the calling area.

If the terminal equipment causes harm to the telephone network, the telephone company will notify you in advance that temporary discontinuance of service may be required. But if advance notice is not practical, the telephone company will notify the customer as soon as possible. Also, you will be advised of your right to file a complaint with the FCC if you believe it is necessary.

The telephone company may make changes in its facilities, equipment, operations or procedures that could affect the operations of the equipment. If this happens, the telephone company will provide advance notice in order for you to make the necessary modifications in order to maintain uninterrupted service.

If trouble is experienced with this equipment, please contact 1-888-4SONYPC (1-888-476-6972), or write to the Sony Customer Information Center, One Sony Drive, Park Ridge, NJ 07656, for repair and/or warranty information. If the trouble is causing harm to the telephone network, the telephone company may request that you remove the equipment from the network until the problem is resolved.

Repair of this equipment should be made only by a Sony Service Center or Sony authorized agent. For the Sony Service Center nearest you, call 1-888-4SONYPC (1-888-476-6972).

This equipment cannot be used on public coin service provided by the telephone company. Connection to Party Line Service is subject to state and possible provincial tariffs. (Contact the state or provincial utility service commission, public service commission, or corporation commission, for information.)

Telephone Consumer Protection Act of 1991 (United States)

The Telephone Consumer Protection Act of 1991 makes it unlawful for any person to use a computer or other electronic device to send any message via a telephone facsimile machine unless such message clearly contains, in a margin at the top or bottom of each transmitted page or on the first page of the transmission, the date and time it is sent and an identification of the business, other entity, or individual sending the message, and the telephone number of the sending machine or such business, other entity, or individual.

In order to program this information into your facsimile machine, see your fax software documentation.

Telephone Consumer Guidelines (Canada)

Please refer to your telephone directory under 'Privacy Issues' and/or 'Terms of Service.' For more detailed information, please contact:

CRTC
Terrasses de la Chaudière, Tour centrale
1 promenade du Portage, 5 étage Hull PQ
K1A 0N2.

This Class B digital apparatus complies with Canadian ICES-003.

Cet appareil numérique de la classe B est conforme à la norme NMB-003 du Canada.

DISPOSAL OF LITHIUM ION BATTERY

You can return your unwanted lithium ion batteries to your nearest Sony Service Center or Factory Service Center.



In some areas the disposal of lithium ion batteries in household or business trash may be prohibited.

For the Sony Service Center nearest you, call 1-888-476-6972 in the United States or 1-800-961-7669 in Canada.

! Do not handle damaged or leaking lithium ion batteries.

! Ne pas manipuler les batteries au lithium-ion qui fuient ou sont endommagées.

! Danger of explosion if battery is incorrectly replaced. Replace only with the same or equivalent type recommended by the manufacturer. Discard used batteries according to the manufacturer's instructions.

! Une batterie non conforme présente un danger d'explosion. La remplacer seulement par une batterie identique ou de type équivalent recommandé par le fabricant. Évacuer les batteries usées selon les directives du fabricant.

! The battery pack used in this device may present a fire or chemical burn hazard if mistreated. Do not disassemble, heat above 212°F (100°C) or incinerate. Dispose of used battery promptly. Keep away from children.

! La manutention incorrecte du module de batterie de cet appareil présente un risque d'incendie ou de brûlures chimiques. Ne pas démonter, incinérer ou exposer à une température de plus de 100°C. Évacuer promptement la batterie usée. Garder hors de portée des enfants.

INDUSTRY CANADA NOTICE

NOTICE: The Industry Canada label identifies certified equipment. This certification means that the equipment meets certain telecommunications network protective, operational and safety requirements as prescribed in the appropriate Terminal Equipment Technical Requirements document(s). The Department does not guarantee the

equipment will operate to the user's satisfaction.

Before installing this equipment, users should ensure that it is permissible to be connected to the facilities of the local telecommunications company. The equipment must also be installed using an acceptable method of connection.

The customer should be aware that compliance with the above conditions may not prevent degradation of service in some situations.

Repairs to certified equipment should be coordinated by a representative designated by the supplier. Equipment malfunctions or any repairs or alterations made by the user to this equipment may give the telecommunications company cause to request that the user disconnect the equipment.

Users should ensure for their own protection that the electrical ground connections of the power utility, telephone lines and internal metallic water pipe system, if present, are connected together. This precaution may be particularly important in rural areas.

Caution: Users should not attempt to make such connections themselves, but should contact the appropriate electric inspection authority, or electrician, as appropriate.

NOTICE: The Ringer Equivalence Number (REN) assigned to each terminal device provides an indication of the maximum number of terminals allowed to be connected to a telephone interface. The termination on an interface may consist of any combination of devices subject only to the requirement that the sum of the Ringer Equivalence Numbers of all the devices does not exceed 5. The Ringer Equivalence Number for this equipment is 0.4.

AVIS DE L'INDUSTRIE CANADA

AVIS: L'étiquette d'Industrie Canada identifie le matériel homologué.

Cette étiquette certifie que le matériel est conforme aux normes de protection, d'exploitation et de sécurité des réseaux de télécommunications, comme le prescrivent les documents concernant les exigences techniques relatives au matériel terminal. Le Ministère n'assure toutefois pas que le matériel fonctionnera à la satisfaction de l'utilisateur.

Avant d'installer ce matériel, l'utilisateur doit s'assurer qu'il est permis de le raccorder aux installations de l'entreprise locale de télécommunication. Le matériel doit également être installé en suivant une méthode acceptée de raccordement. L'abonné ne doit pas oublier qu'il est possible que la conformité aux conditions énoncées ci-dessus n'empêche pas la dégradation du service dans certaines situations.

Les réparations de matériel homologué doivent être coordonnées par un représentant désigné par le fournisseur. L'entreprise de télécommunications peut demander à l'utilisateur de débrancher un appareil à la suite de réparations ou de modifications effectuées par l'utilisateur ou à cause de mauvais fonctionnement.

Pour sa propre protection, l'utilisateur doit s'assurer que tous les fils de mise à la terre de la source d'énergie électrique, des lignes téléphoniques et des canalisations d'eau métalliques, s'il y en a, sont raccordés ensemble. Cette précaution est particulièrement importante dans les régions rurales.

Avertissement: L'utilisateur ne doit pas tenter de faire ces raccordements lui-même; il doit avoir recours à un service d'inspection des installations électriques, ou à un électricien, selon le cas.

AVIS: L'indice d'équivalence de la sonnerie (IES) assigné à chaque dispositif terminal indique le nombre maximal de terminaux qui peuvent être raccordés à une interface.

La terminaison d'une interface téléphonique peut consister en une combinaison de quelques dispositifs, à la seule condition que la somme d'indices d'équivalence de la sonnerie de tous les dispositifs n'excède pas 5.

Contents

<i>Welcome</i>	1
Features	1
Unpacking Your Notebook Computer	2
<i>Setting Up Your VAIO® Notebook Computer</i>	5
Locating Controls and Connectors.....	5
Connecting a Power Source	9
Starting Your Computer	13
Shutting Down Your Computer	14
Registering Your Computer	15
Using the Keyboard.....	16
Using the Touchpad	22
Using the Floppy Disk Drive	23
Using the DVD-ROM	25
Using PC Cards.....	29
Using Smart Connect.....	32
Using Infrared Communication Devices.....	33
Using Power-Saving Modes.....	35
Using a Second Battery Pack.....	37
Using the Weight Saver	40

<i>Connecting Peripheral Devices</i>	<i>43</i>
Connecting a Phone Line	44
Connecting the Port Replicator	45
Connecting a Printer	49
Connecting an External Display.....	50
Connecting an External Mouse or Keyboard	53
Connecting External Speakers.....	54
Connecting an External Microphone.....	55
Connecting a Digital Still Camera or Other Serial Device.....	56
Connecting a Digital Video Camera Recorder.....	57
Connecting a Universal Serial Bus (USB) Device	58
 <i>Troubleshooting</i>	 <i>59</i>
Changing the Window Design of Sony Software.....	67
Using the System Recovery and Application Recovery CDs.....	68
About the Software on Your Computer.....	71
About Your Recovery CDs.....	75
For Answers to Your Software Questions	76
 <i>Adding Memory.....</i>	 <i>79</i>
Specifications	82
 <i>Index.....</i>	 <i>85</i>

Welcome

Congratulations on your purchase of the Sony VAIO[®] notebook computer. Sony has combined leading-edge technology in audio, video, computing, and communications to provide you with state-of-the-art personal computing.

Features

 For a complete description of the specifications of your VAIO[®] notebook computer, see page 82.

- ❑ **Exceptional performance:** Your notebook includes a fast Intel[®] Pentium[®] III processor and a V.90 compatible modem.*
- ❑ **Portability:** The rechargeable battery pack provides hours of use without AC power.
- ❑ **Sony audio and video quality:** High-quality MPEG1/MPEG2 video, which supports full-screen display and enables you to take advantage of today's advanced multimedia applications, games, and entertainment software.
- ❑ **Multimedia features:** Enjoy the stereo speakers or use a headphone (not supplied) to listen to audio and video CDs.
- ❑ **Windows[®] 98 Second Edition:** Your system includes the latest operating system from Microsoft.
- ❑ **Communications:** Access popular online services, send e-mail, browse the Internet, and use fax features.
- ❑ **Digital Versatile Disc (DVD):** This new optical storage technology provides increased storage capacity and a rich multimedia computing experience. DVD-ROM drives play both DVD-ROM and CD-ROM discs.

* Actual upload and download speeds may vary due to line conditions, ISP support, and government regulations.

Unpacking Your Notebook Computer

Remove the following hardware items from the box:

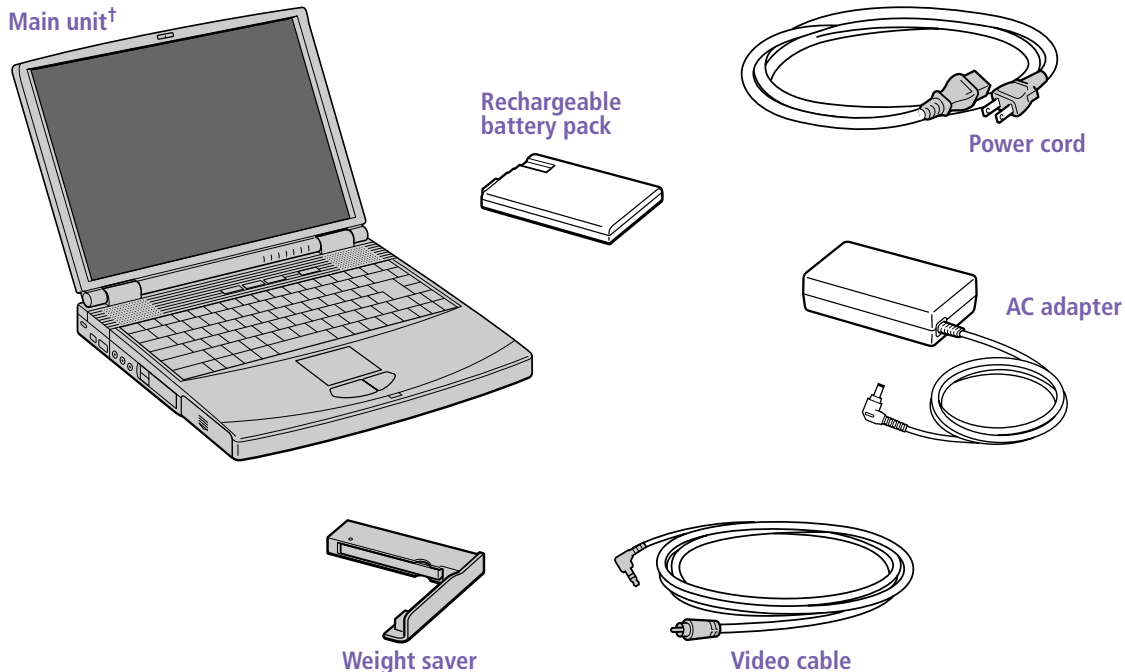

† The removable floppy disk drive is located in the multipurpose bay.

Manuals

- ❑ *Read Me First* contains Frequently Asked Questions, the most up-to-date information on using your computer, and software support information.
- ❑ The *VAIO® Notebook Computer User Guide* (this manual) contains information on how to get the most from your computer, find help, and solve common problems. It also includes product specifications.
- ❑ *The VAIO® Consumer Information Guide* contains ergonomic considerations and your computer's limited warranty statement.
- ❑ The *Microsoft® Windows® 98 Getting Started* manual explains how to use the basic features of the Windows® 98 operating system.

Recovery CDs

- System Recovery CD(s)
- Application Recovery CD(s)

Software CDs

- Microsoft[®] Works Suite 99 (5 CD set)

Other

- Setting up your VAIO[®] Notebook Computer (poster)
- Packet containing special product offers

Setting Up Your VAIO® Notebook Computer

Locating Controls and Connectors

Front

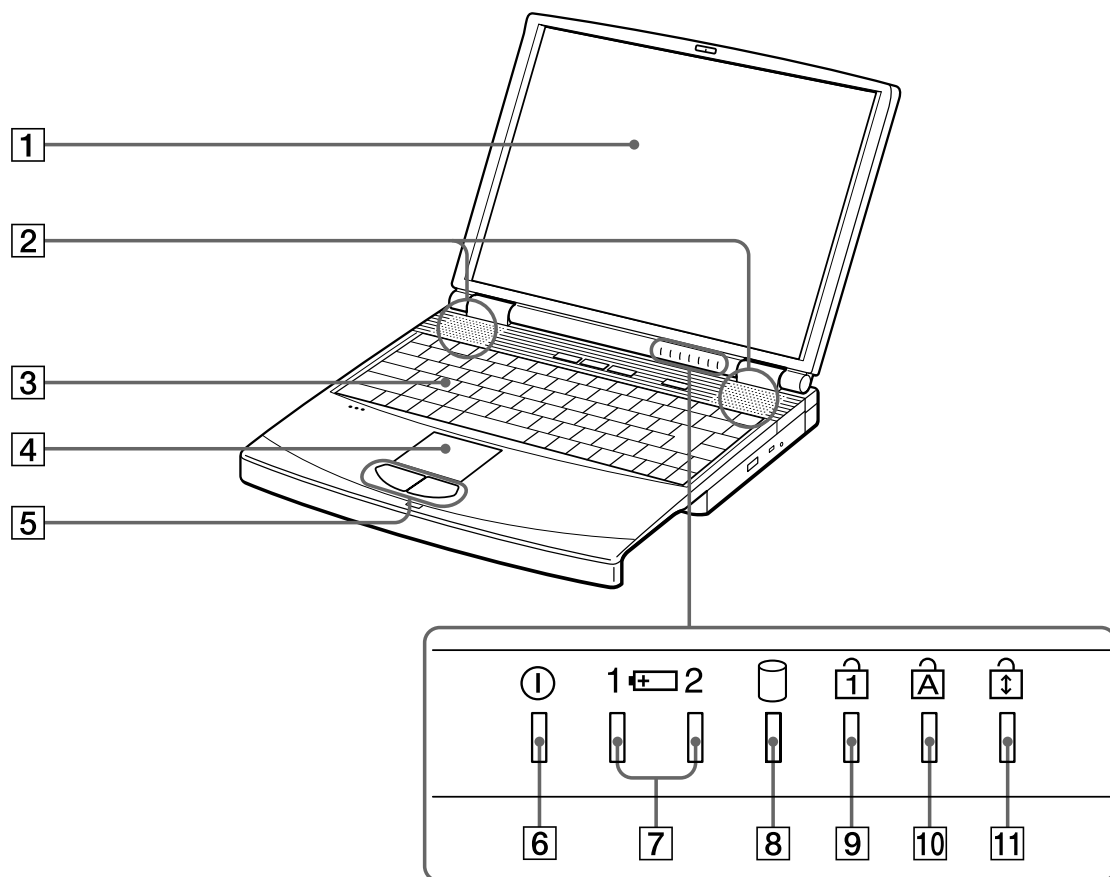

- | | | | |
|----------|---|-----------|---|
| 1 | LCD(Liquid Crystal Display)screen (page 20) | 7 | Battery 1 and 2 indicators (pages 11, 19) |
| 2 | Speakers (pages 20, 54) | 8 | Hard disk drive indicator (page 19) |
| 3 | Keyboard (page 16) | 9 | Num Lock indicator (page 19) |
| 4 | Touchpad (page 22) | 10 | Caps Lock indicator (page 19) |
| 5 | Left/right buttons (page 22) | 11 | Scroll Lock indicator (page 19) |
| 6 | Power indicator (page 11) | | |

Left

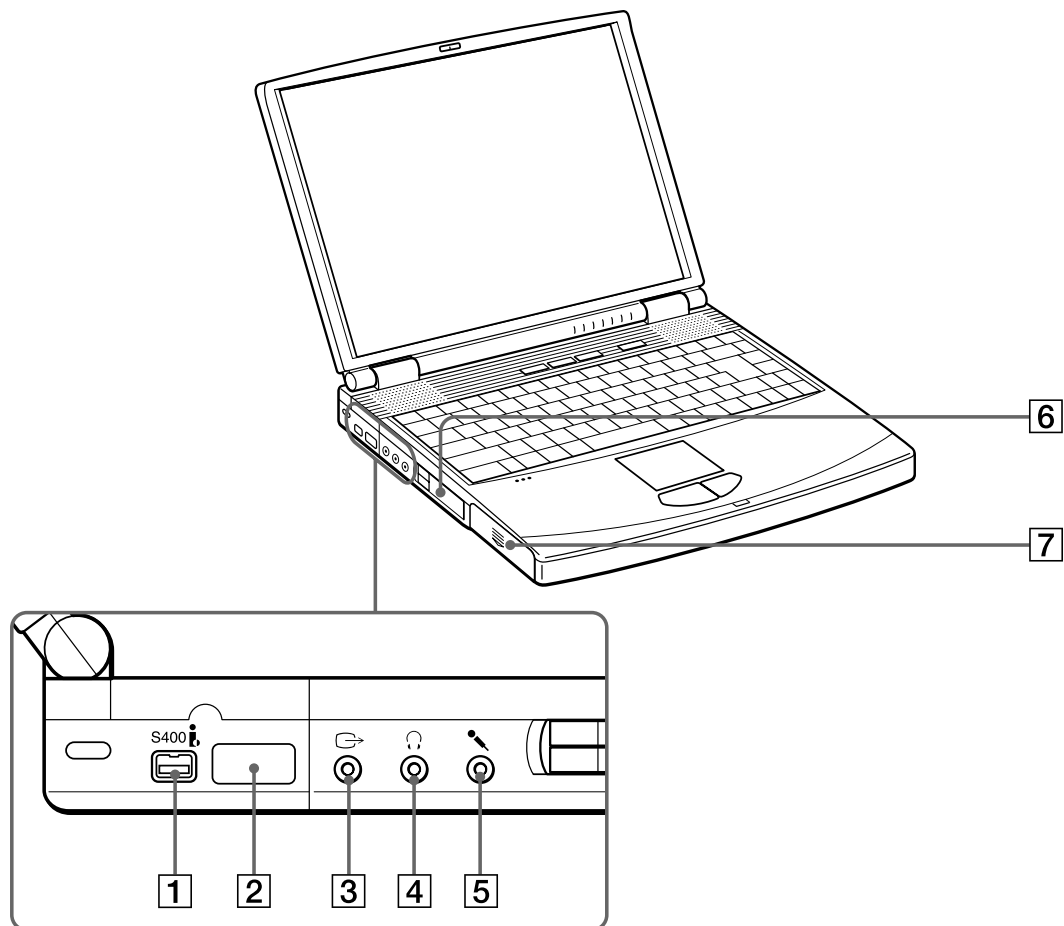

- | | | | |
|----------|------------------------------------|----------|-------------------------------------|
| 1 | i S400 i.LINK® connector (page 57) | 5 | Microphone connector (pages 51, 55) |
| 2 | Infrared port (page 33) | 6 | PC card slots (page 29) |
| 3 | Video out | 7 | Battery bay (page 10) |
| 4 | Headphone connector (pages 51, 54) | | |

Right

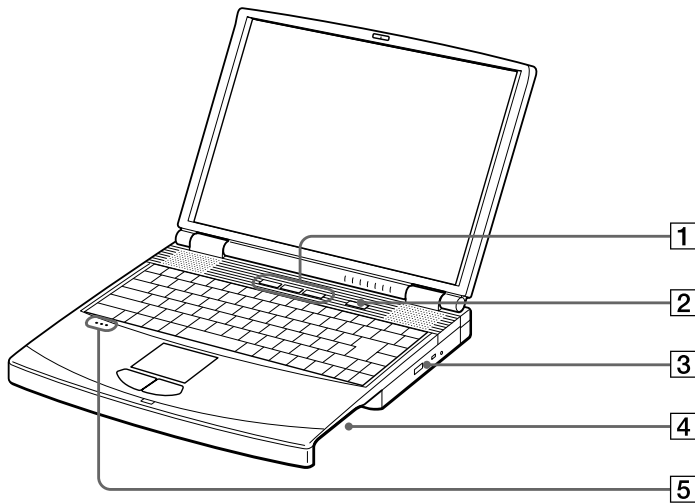

- 1** PPK buttons (see the online document *Customizing Your VAIO® Notebook Computer* for information on use)

2 Power button

3 DVD-ROM drive (page 25)
- 4** Multipurpose bay (pages 23, 37, 40)

5 Internal microphone

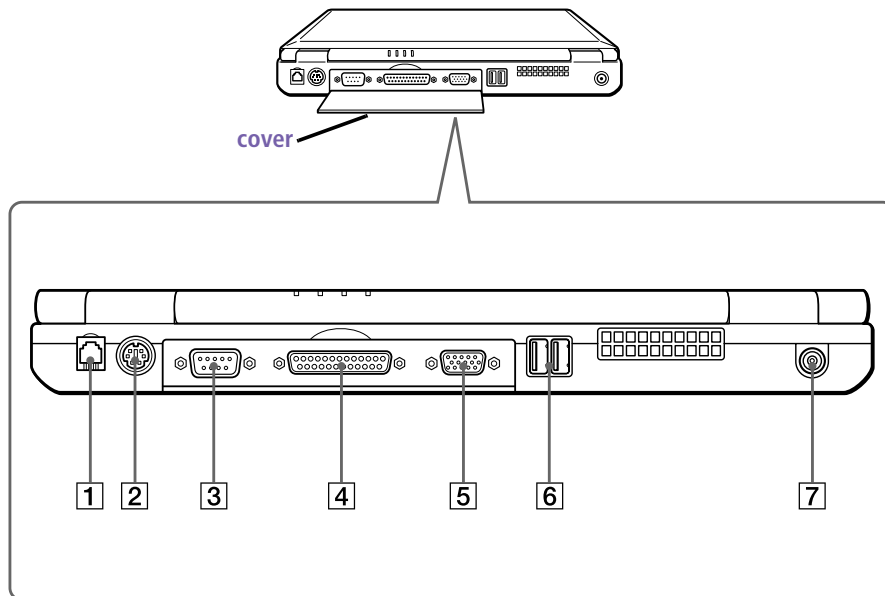

Back





- 1** Phone line jack (page 44)

2  Mouse/Keyboard connector (page 53)

3  Serial connector (page 56)

4  Printer connector (page 49)
- 5**  Monitor connector (page 50)

6  USB connectors (page 58)

7  DC In connector (page 9)

 There is a ventilation slot located between the USB connector and the DC In connector. Do not cover the ventilation slot when your computer is on.

Bottom

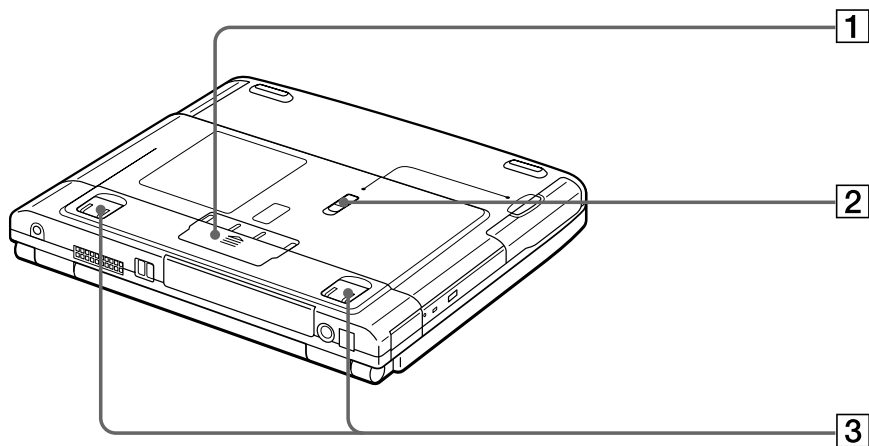

1 Port replicator connector cover (pages 46, 48)

3 Tilt stands

2 Multipurpose bay RELEASE lever (pages 39, 41)

Connecting a Power Source

You can use either AC power or a rechargeable battery pack as a power source.

Using the AC Adapter

- 1 Plug the cable attached to the AC adapter into the DC In connector on the computer.
- 2 Plug one end of the power cord into the AC adapter.
- 3 Plug the other end of the power cord into an AC outlet.

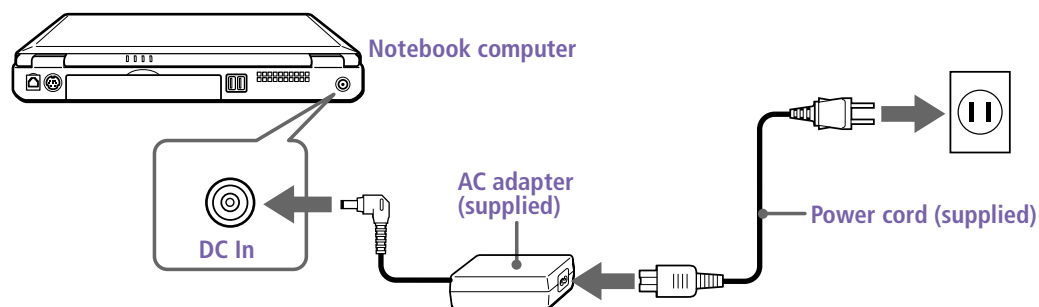

Using Battery Power

You can use one or two battery packs as a source of power. The second battery pack inserts into the multipurpose bay on the right side of the computer. (See “Using Power-Saving Modes” on page 35.) Additional battery packs are available as a separate option.

The battery pack that comes with your computer is not fully charged at the time of purchase. Follow the steps below to insert and charge the battery pack.

To insert the battery pack

- 1 Open the cover of the battery bay.

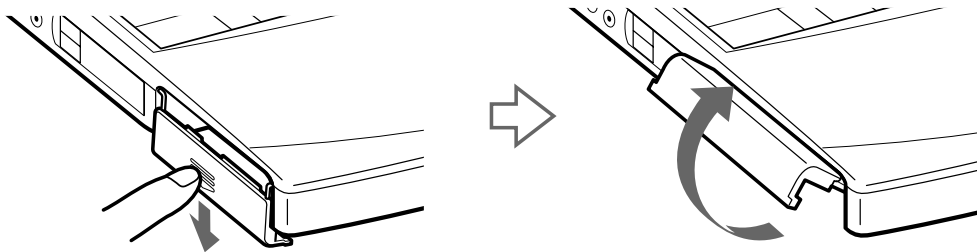

- 2 Insert the battery pack into the battery bay on the left side of the computer.

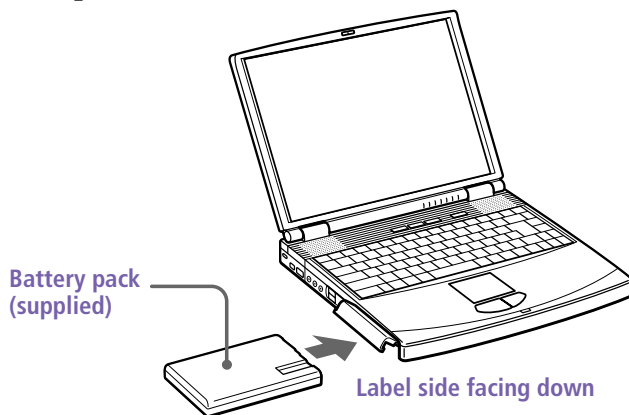

- 3 Close the cover of the battery bay until it clicks.



When attaching your computer to the port replicator, do not attempt to insert or remove the battery pack. Lifting and turning the computer with a port replicator attached could cause a temporary loss of power.



To charge the battery pack

- 1 Connect the AC adapter to the computer.
- 2 Insert the battery pack.

The computer automatically charges the battery (the battery indicator light flashes in a double-blink pattern as the battery charges). When the battery is 85 percent full, the battery indicator light turns off. This process takes approximately two hours. To charge the battery completely, continue charging for an additional hour. See “Displaying Detailed Battery Information” in the online document *Customizing Your VAIO® Notebook Computer* for information on checking the battery life.

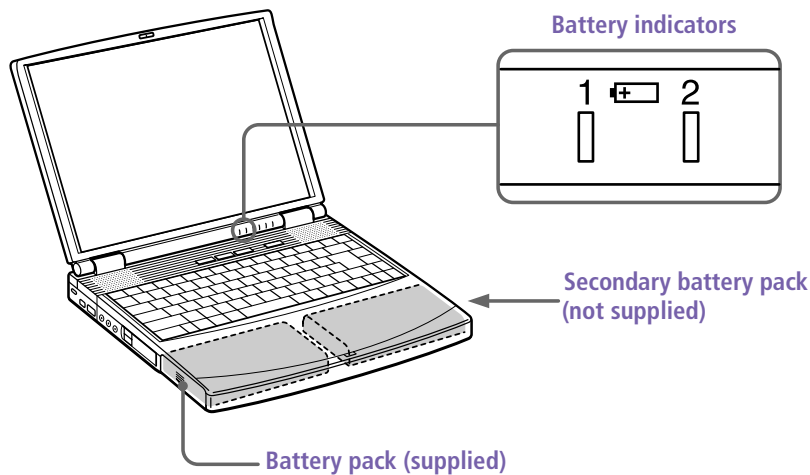
There are two battery indicator lights on the computer:



<i>Battery Indicator</i>	<i>Meaning</i>
1 	Indicates the status of the battery pack in the battery bay on the left side of the computer.
 2	Indicates the status of the battery pack in the multipurpose bay on the right side of the computer.

<i>Battery Indicator Light Status</i>	<i>Meaning</i>
On	The computer is using battery power.
Single blink	The battery is running out of power.
Double blink	The battery is charging.
Off	The computer is using AC power.

When the battery power is running low, both the battery and power indicators blink.

When the computer is directly connected to AC power and has a battery pack in the battery bay, it uses power from the AC outlet.

See "Using a Second Battery Pack" on page 37 for information on installing and charging a battery pack in the multipurpose bay.

Keep the battery pack in the computer while it is directly connected to AC power. The battery pack continues to charge while you are using the computer.

If the battery level falls below 10%, you should either attach the AC adapter to recharge the battery or shut down your computer and insert a fully charged battery.

You can extend battery life by changing the power-management modes in the PowerPanel utility. See "Using Power-Saving Modes" on page 35.

The battery pack supplied with your computer is a lithium ion battery and can be recharged at any time. Charging a partially discharged battery does not affect battery life.

The battery indicator light is on while you use the battery pack as a power source. When battery life is nearly depleted, the battery indicator starts flashing.

For some software applications and some peripheral devices, your computer may not enter System Hibernation mode when the battery life is low. To avoid loss of data when using battery power, you should save your data frequently and manually activate a power-management mode, such as System Suspend or System Hibernation.

To remove the battery pack

- 1 Open the cover of the battery bay.
- 2 Pull out the battery pack.

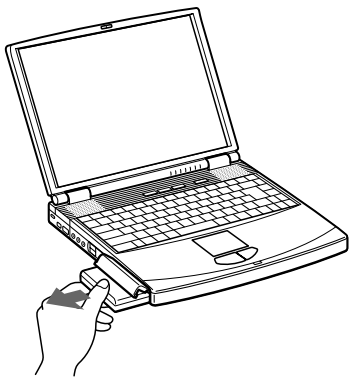

- 3 Close the cover of the battery bay.

! You may lose data if you remove the battery pack while the computer is on and not connected to the AC adapter or if you remove the battery while the computer is in System Suspend mode.

Starting Your Computer

- 1 Slide the LCD lock lever in the direction of the arrow, and lift the cover.

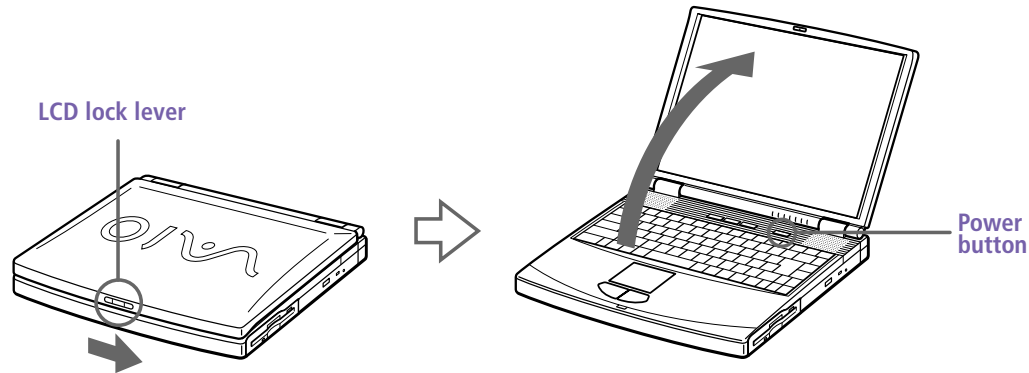

- 2 Press the power button on top of the computer until the green power indicator light turns on.

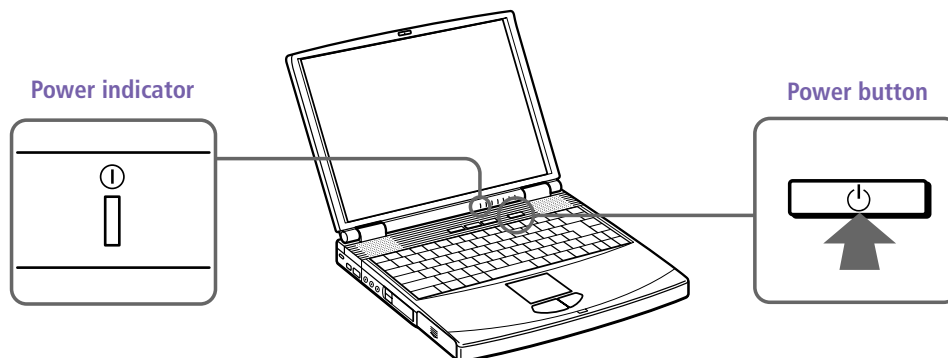

 If you hold the power button in the On position for more than four seconds, the computer turns off.

- 3 If necessary, adjust the brightness controls for the LCD display. To decrease the brightness, press Fn+F5 and then the down or left arrow key. To increase the brightness, press Fn+F5 and then the up or right arrow key.

Shutting Down Your Computer

! To avoid potential loss of data, follow these steps to shut down your computer.

- 1 Click the Start button on the Windows® 98 taskbar.
- 2 Click Shut Down at the bottom of the Start menu to display the Shut Down Windows dialog box.



- 3 Select Shut down.
- 4 Click OK.

 Respond to any prompts warning you to save documents.

- 5 Wait for your computer to turn off automatically. The power indicator (green) turns off.
- 6 Turn off any peripherals connected to your computer.

 If you are unable to shut down your computer using the steps described above, press the Ctrl+Alt+Delete keys at the same time to restart the computer. If you are unable to restart the computer in this way, you can press the power button and hold it for four seconds. This operation may result in data loss.

During a period of inactivity, you can conserve battery life by using System Suspend mode. See "Controlling Power Management" in the online document *Customizing Your VAIO® Notebook Computer*.

Registering Your Computer

You can take advantage of Sony's commitment to quality customer support and receive the following benefits by registering your computer with Sony.

- ❑ **Sony Customer Support** – Talk to a Support Representative to troubleshoot problems you may be having with your computer.
- ❑ **Extended Limited Warranty** – Protect your investment. Extend your Warranty nine months for a total of 12 months from the original date of purchase when you register your computer.
- ❑ **Express service** – Provides convenient resolution of problems.

If you have not already registered, follow these steps to use your notebook computer's online registration service.



You must connect your phone line before using any online services, including the online registration service. See "Connecting a Phone Line" on page 44.

- 1 Click the Sony VAIO Registration icon on the VAIO desktop.
- 2 Enter the information requested on the first online registration form. Press the Tab key to move from box to box.
- 3 Click the Next button to advance to the next form.
- 4 Complete the remaining forms by clicking the Next button each time you complete a form.



The computer automatically transfers your registration information using your built-in modem and a toll-free telephone number.

Using the Keyboard

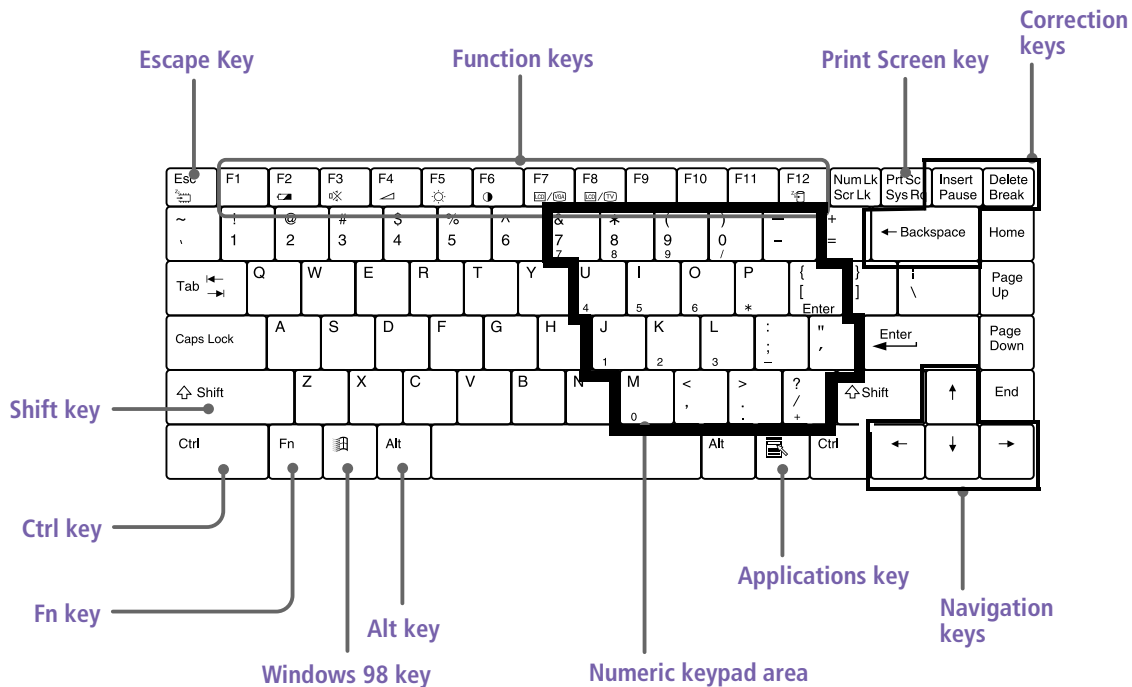







Your keyboard is very similar to a typewriter's, but the keyboard has additional keys that perform specific computer-related tasks.





Key	Description
Numeric keypad area	Contains the keys found on a typical calculator. Use the numeric keypad area to type numbers or to perform mathematical calculations such as addition and subtraction. Note that you must press the Num Lock key to activate the numeric keypad. (When you do so, the Num Lock light will be on.)
Navigation keys	Several keys are devoted to moving the cursor on the screen.
Correction keys	The Insert, Back Space, and Delete keys enable you to make corrections in your documents.
Function keys	The 12 function keys along the top of the keyboard are used to perform designated tasks. For example, in many applications, F1 is the Help key. The task associated with each function key may vary from one application to the next.
Escape key	The Esc (Escape) key is used to cancel commands.

<i>Key</i>	<i>Description</i>
Print Screen key	The Print Screen key takes an electronic snapshot of the screen and places it in the Windows Clipboard. You can then paste the screen shot into a document and print it.
Operator keys	Several keys are always used with at least one other key: Ctrl, Alt, and Shift. When held down with another key, the Ctrl (Control) and Alt (Alternate) keys offer another way to give commands. For example, in many applications, instead of choosing the Save command from a menu, you can hold down Ctrl and press S (referred to as Ctrl+S). The Shift key operates the same way as on a typewriter; it is used to produce capital letters or special symbols such as @ and \$.
Windows 98 key 	The key with the Windows logo displays the Windows 98 Start menu; it is the equivalent of clicking the Start button on the taskbar. See “Combinations and Functions with the Windows 98 Key” on page 18.
Fn key	The Fn key is used in combination with other keys to issue commands. See “Combinations and Functions with the Fn Key” on page 20.
Applications key 	The Applications key displays a shortcut menu of context-sensitive choices. Pressing this key is the equivalent of clicking the right mouse button.

Combinations and Functions with the Windows 98 Key

<i>Combination</i>	<i>Function</i>
+ F1	Displays Windows Help.
 + Tab	Switches the selected button on the taskbar.
 + E	Displays Windows Explorer.
 + F	Displays the Windows Find: All Files window to find a file or folder. This is the equivalent of selecting Find and then Files or Folders from the Start menu.
 + Ctrl + F	Displays the Windows Find: Computer window where you can locate other computers. This is the equivalent of selecting Find and then Computer from the Start menu.
 + M	Minimizes all displayed windows.
Shift +  + M	Returns all minimized windows to their previous size.
 + R	Displays the Run window. This is the equivalent of selecting Run from the Start menu.
Fn +  + Insert	Displays the Properties window. This is the equivalent of double-clicking the System icon in the Control Panel.

Indicators

<i>Indicator</i>	<i>Function</i>
Power ①	Light is green when the power to the computer is turned on. Light is red in System Idle mode, and flashes red in System Suspend mode. The light turns off when the computer is in System Hibernation mode or powered off.
Battery 1 1 	Indicates the status of the battery inserted in the battery bay on the left side of the computer.
Battery 2  2	Indicates the status of the battery inserted in the multipurpose bay on the right side of the computer.
Hard disk 	Lights when data is being read from or written to the hard drive. Do not enter System Suspend mode or turn off the computer when this indicator light is on.

<i>Light</i>	<i>On</i>	<i>Off</i>
Num Lock	The number keys in the numeric keypad are active.	The alphanumeric character keys in the keypad area are active.
Caps Lock	The letters appear in uppercase as you type. The Shift key lowers the case of typed letters when Caps Lock is on.	Letters appear in lower case as you type (unless you hold down the Shift key).
Scroll Lock	The screen scrolls differently. (Exactly how it scrolls depends on the specific application. It has no effect in many applications.)	Information moves across the display normally.

Combinations and Functions with the Fn Key

Combinations/ Feature

Function

Fn+  (ESC)
System Suspend

Puts the system into System Suspend mode, a power-management state. To return the system to the active state, press any key or press the power button on your computer.

Fn+  (F2)
Display power source
status

Displays the power source status, as in the example below:



Using AC
power



Charging a
battery pack

Fn+  (F3)
Mute On/Off

Toggles the built-in speaker off and on.

Fn+  (F4)
Speaker volume

Adjusts the built-in speaker volume.
To increase volume, press Fn+F4, then **↑** or **→**.
To decrease volume, press Fn+F4, then **↓** or **←**.

Fn+  (F5)
Brightness control

Adjusts the brightness of the LCD.
To increase light intensity, press Fn+F5 and then **↑** or **→**.
To decrease light intensity, press Fn+F5 and then **↓** or **←**.



Fn+  (F6)
Contrast control

Fn +F6: not available on this model

Fn+  /  (F7)
Switch to the
external monitor/LCD

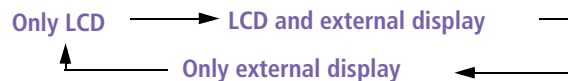
Toggles through the LCD, external display (connected to the  Monitor connector) and both LCD and external display.



Fn+  only /
 (F8)
Control TV out

Toggles between LCD-only and dual LCD/TV display modes.



<i>Combinations/ Feature</i>	<i>Function</i>
Fn+  (F12) System Hibernation	Provides for the lowest level of power consumption. When you execute this command, the state of the system and state of the peripheral devices are written to the hard disk and the system power is turned off. To return the system to its original state, use the power button to turn on power.
Fn+D Video standby	Turns off the LCD to save power. To turn the LCD back on, press any key.
Fn+F Change the display size	Zooms the display size in or out when the display is set to a low resolution.
Fn+S System Idle	Puts the system into System Idle mode, a power-management state. To return the system to the active state, press any key.

 Some functions are not available until Windows launches.

Using the Touchpad

The keyboard contains a cursor-pointing device called a touchpad. You can point to, select, drag, and scroll objects on the screen using the built-in touchpad.

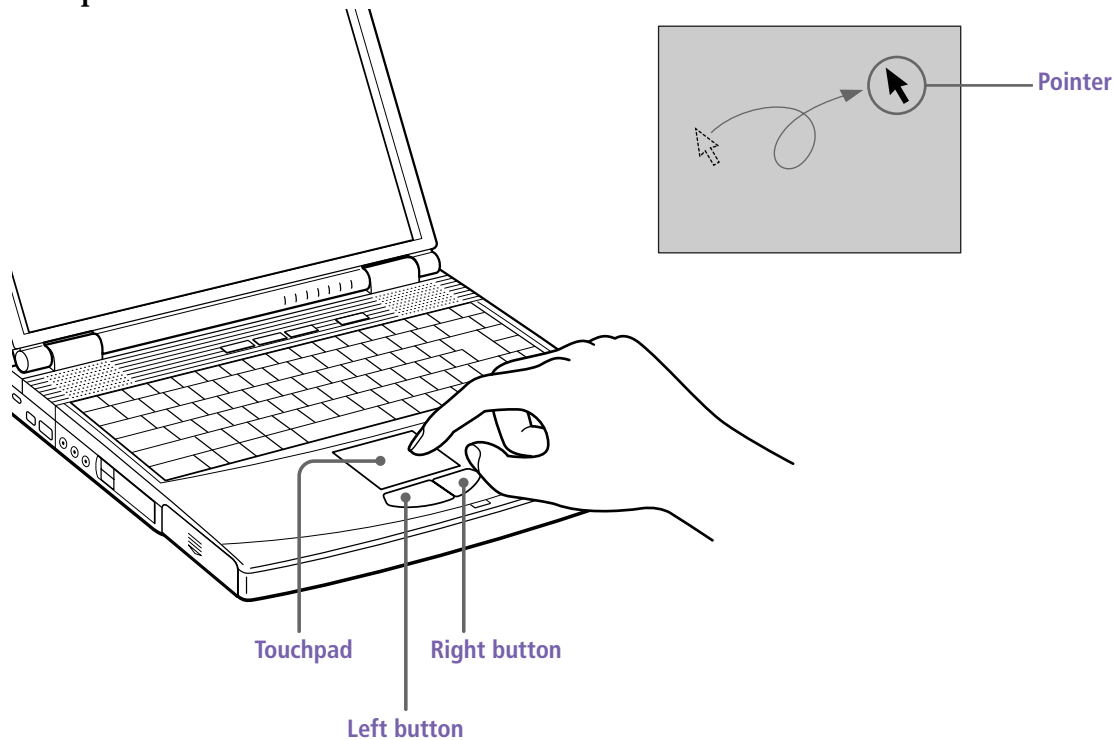

Action	Description
Point	Slide one finger on the touchpad to place the pointer on an item or object.
Click	Press the left button once.
Double-click	Press the left button twice.
Right-click	Press the right button once. In many applications, this action displays a shortcut menu of context-sensitive choices.
Drag	Slide one finger while pressing the left button.
Scroll	Move your finger along the right edge of the touchpad to scroll vertically. Move your finger along the bottom to scroll horizontally. (The scroll function is available only with applications that support a touchpad scroll feature.)



See Mouse Help for information on touchpad features, such as clicking both buttons simultaneously, adjusting touchpad speed, and Easy Launcher functions. To access Mouse Help, click the Start button, select Settings, and then Control Panel. Click the Mouse icon in the Control Panel and click the Help button.

Using the Floppy Disk Drive

The computer comes with the floppy disk drive in the multipurpose bay.

To insert a diskette

- 1 Hold the diskette with the label side facing up.
- 2 Gently push the diskette into the drive until it clicks into place.

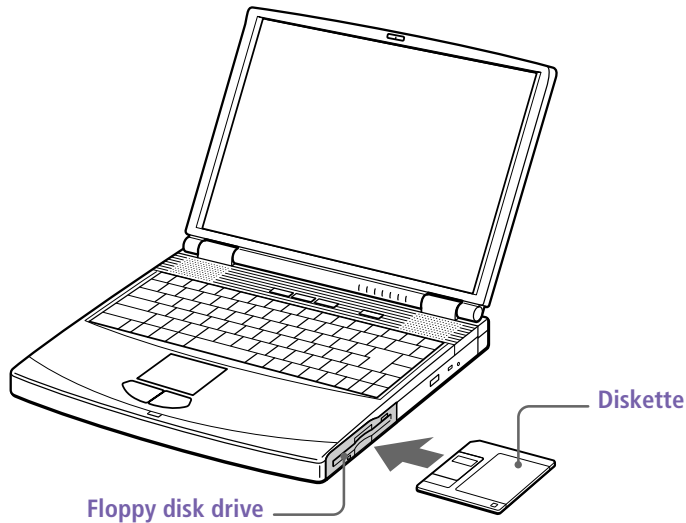

To remove a diskette

- ❑ When you finish using the diskette, wait until the LED indicator light turns off and then press the Eject button to remove the diskette.

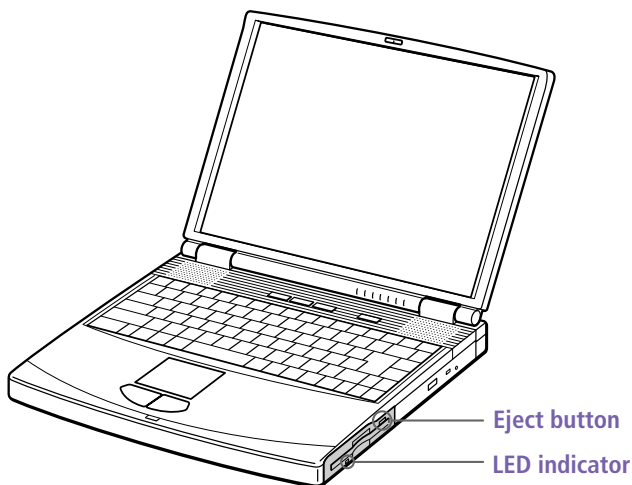

 Do not press the Eject button when the LED indicator is turned on. Otherwise, data may be lost.

To remove the floppy disk drive

- 1 Turn off the computer.
- 2 There is a RELEASE lever on the bottom of the computer. Slide this lever in the direction of the arrow.

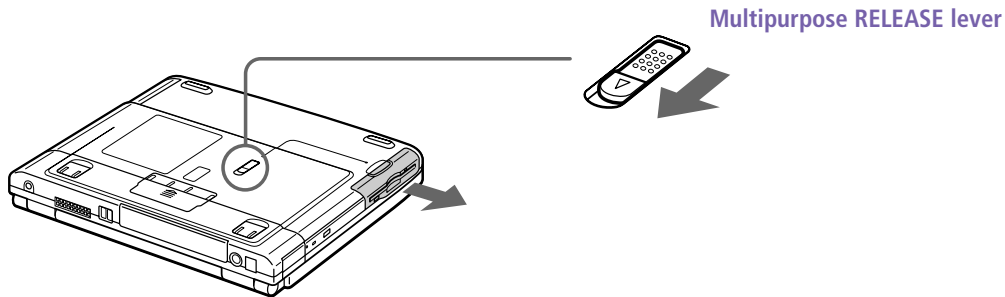

- 3 Slide the drive out of the multipurpose bay.
- 4 Insert the weight saver. See “Using the Weight Saver” on page 40.

To reinsert the floppy disk drive

- 1 Turn off the computer.
- 2 If another device is in the multipurpose bay, remove the device. See “To remove the floppy disk drive” on page 24 or “To remove the second battery pack” on page 39.
- 3 Insert the floppy disk drive into the multipurpose bay with the VAIO label facing up. Continue pushing the drive into the bay until the RELEASE lever locks into place.

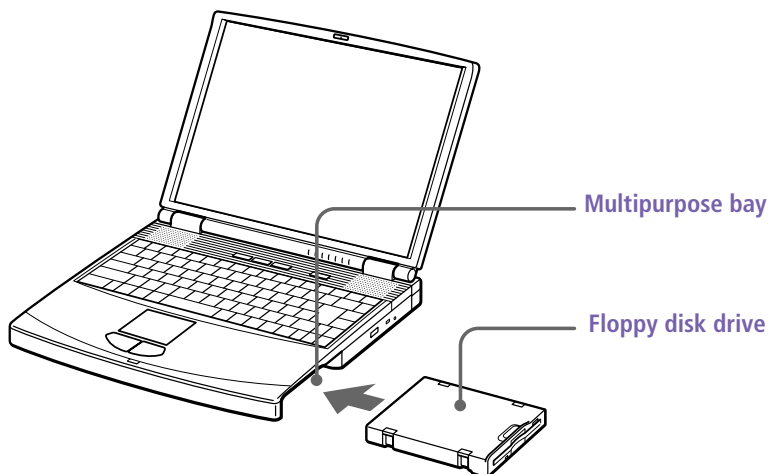

Using the DVD-ROM

Your computer comes with a DVD-ROM drive. The DVD-ROM drive plays both DVD-ROMs and CD-ROMs.

To insert a disc

- 1 Turn on the computer.

 When the computer is in System Suspend or System Hibernation mode, you cannot insert a disc. See "Controlling Power Management" in the document *Customizing Your VAIO® Notebook Computer* for more information on System Suspend and System Hibernation modes.

- 2 Press the Eject button to open the DVD-ROM drive.

The tray slides out.

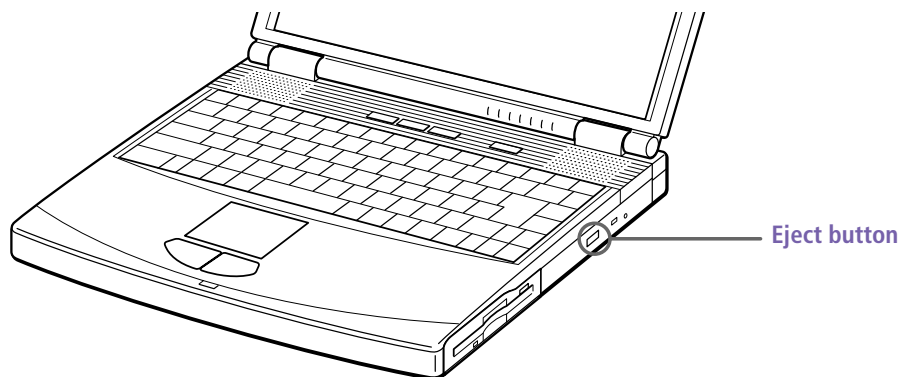

- 3 Place a DVD-ROM/CD-ROM in the tray with the label side facing up. For DVD-ROMs, which can be played on both sides, the side of the disc facing up is the side that plays. Push the disc onto the hub until the disc clicks into place.

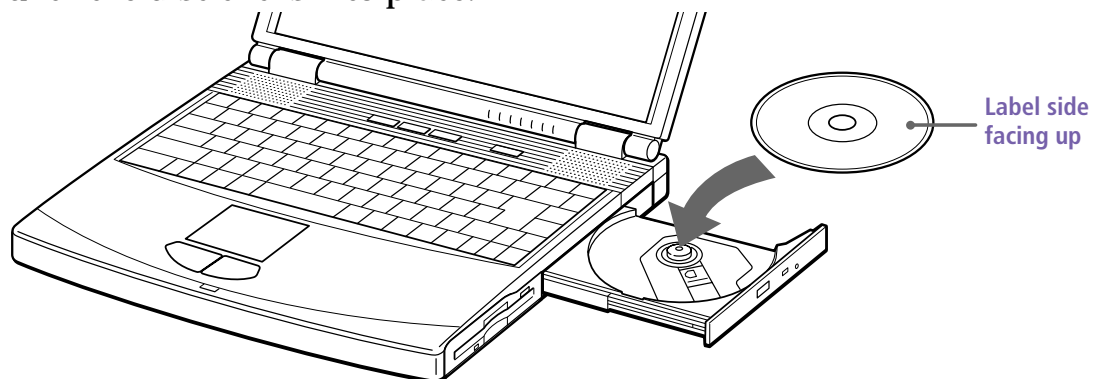

4 Close the tray by pushing it gently.

 Be sure to seat the disc firmly over the hub fingers. If you do not seat the disc firmly, you could damage your DVD-ROM drive and you may not be able to open the tray.

When you finish using a disc, wait until the LED indicator light turns off, then press the Eject button to remove the disc.

When the computer is in System Suspend or System Hibernation mode, you cannot remove a disc. See "Controlling Power Management" in the online document *Customizing Your VAIO® Notebook Computer* for more information about System Suspend and System Hibernation modes.

If the disc does not come out when you press the Eject button, turn off the computer and insert a thin, pointed object into the manual eject hole.

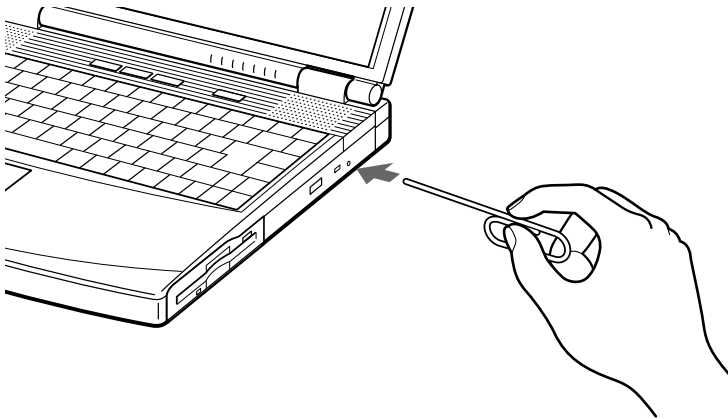

To play DVD-ROMs

To achieve optimum performance when playing DVD-ROMs, you should use the following recommendations: Your computer should not be connected to the port replicator while playing DVD movies or using DVD applications. Close any open applications before playing a DVD movie. The DVD player automatically adjusts the screen properties when you play a DVD movie. Depending on the display setup properties you have selected, you may need to use the Fn + F command to expand the movie to full-screen size.

 When playing DVD movies on battery power, set the power management profile to DVD. With other profiles, the movies are choppy. As an alternative, you can set the power-management profile to Automatic Profile Selection, which will cause the DVD profile to be selected automatically whenever you insert a DVD. See "Controlling Power Management" in the online document *Customizing Your VAIO® Notebook Computer* for information on how to set the power-management profile.

Playing a DVD

- ❑ You can play DVDs using a DVD-ROM drive and the Media Bar software. See the online manual that came with the Media Bar software for details.
- ❑ While playing a DVD, the display mode is 1024 x 768 dots and the number of colors is set to 256. This improves play performance.

- ! Some discs recorded at 20 or 24 bits may produce noise while playing. If you have audio devices connected, this may cause damage to your hearing and the speakers. Reduce the volume before playing such discs.
- ! You cannot switch between LCD and TV if you press Fn+F8 when a DVD is inserted in the DVD-ROM drive.

To minimize the play mode window, see “To play a DVD in Normal Display Mode” below.

If you have connected a TV, follow the instructions in “Selecting the Display Mode” in the online document *Customizing Your VAIO® Notebook Computer*.

To play a DVD in Normal Display Mode

To play a DVD in a display mode of 1024 x 768 (16 bits):

- 1 Click Stop in the DVD Player window. If you have maximized the DVD player window, right-click the window to display the pop-up menu. Choose “Show Control Panel” to display the DVD player window forward.
- 2 Click Setting to display the DVD Settings window.



- 3 Remove the check from “Set to display 256 colors when playing back DVD.”
- 4 Click OK to confirm the setting.

To display wallpaper while playing a DVD

- 1 Follow the instructions in “To play a DVD in Normal Display Mode” on page 27, or
- 2 Follow step 1 and step 2 of “To play a DVD in Normal Display Mode” on page 27, then remove the check from the check box labeled “Do not show wallpaper when playing back DVD.”

Using PC Cards

Your computer includes two PC card slots. PC cards allow you to connect portable external devices such as another hard disk drive, or to connect a network.

 The PC card slots can accommodate two Type I or two Type II PC cards, or one Type III PC card. These slots are compatible with Card Bus.

Some PC cards may require that you disable idle devices when using the PC card. You can use Sony Notebook Setup to disable devices. See "Displaying the Sony Notebook Setup Screen" in the online document *Customizing Your VAIO® Notebook Computer* for details.

Be sure to use the most recent software driver provided by the PC card manufacturer.

If an "!" mark appears on the Device Manager tab in the System Properties dialog box, remove the software driver and then reinstall it.

You may not be able to use some PC cards or some functions of the PC card with this computer.

To insert a PC card

Use the lower slot for Type III PC cards.

 You do not need to shut down the computer before inserting or removing a PC card.

- 1 Pull the PC card release button out from the computer and push it in toward the computer.

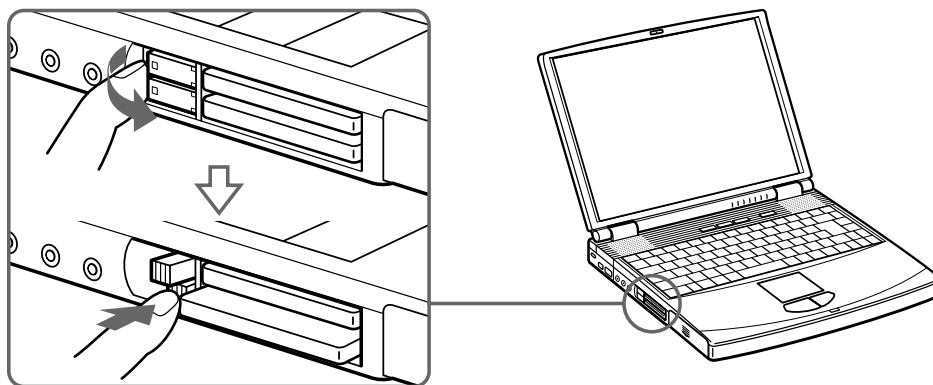

2 Remove the PC card slot protector.

When you use a Type III PC card, you need to remove both the top and bottom PC card slot protectors.

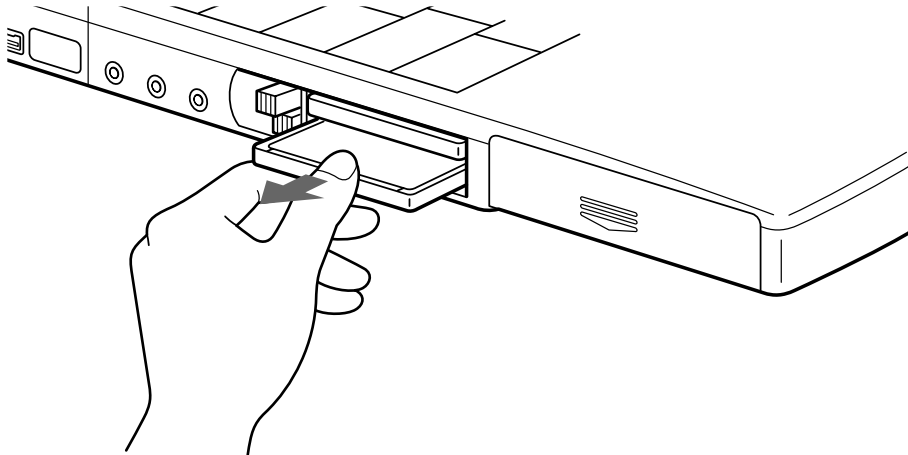

3 Insert the PC card into the PC card slot, front label facing up. Gently push the card into the slot until the card is fixed into the connector. The release button comes out.

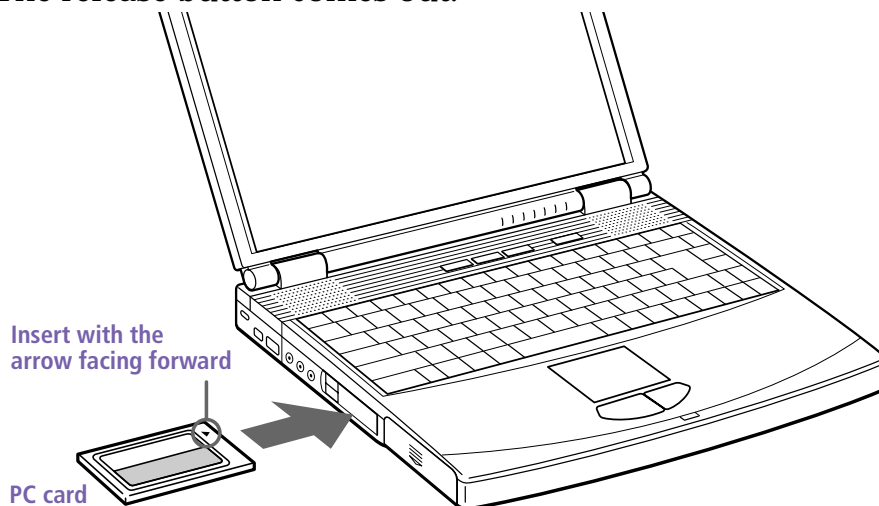

Do not force a card into the slot as this may damage the connector pins. If you have difficulty inserting a card, check that you are inserting the card with the correct orientation. See the manual that came with your PC card for more information on use.

For some PC cards, if you alternate between normal power operation and the System Suspend or System Hibernation power-management modes while the card is inserted, you may find that a device connected to your system is not recognized. Reboot your system to correct the problem.

To remove a PC card

- 1 Close any applications that are using the PC card.
- 2 Click the PC card icon in the taskbar and close the card window.
- 3 Pull the PC card release button up and press it in toward the computer.
- 4 Gently grasp the card and pull it out.
- 5 Insert the PC card slot protector back into the empty slot.

Using Smart Connect

The preinstalled Smart Connect software allows you to use an i.LINK cable (not supplied) to connect your VAIO Notebook Computer to another VAIO computer that also has Smart Connect. You can then use one computer to copy, delete, and edit files on the other computer. You can also print from a printer attached to either computer.



When you use Smart Connect to connect two VAIO computers, you must assign each computer a unique name by which it can be identified when the two computers are networked.

See the Smart Connect online help for more information.

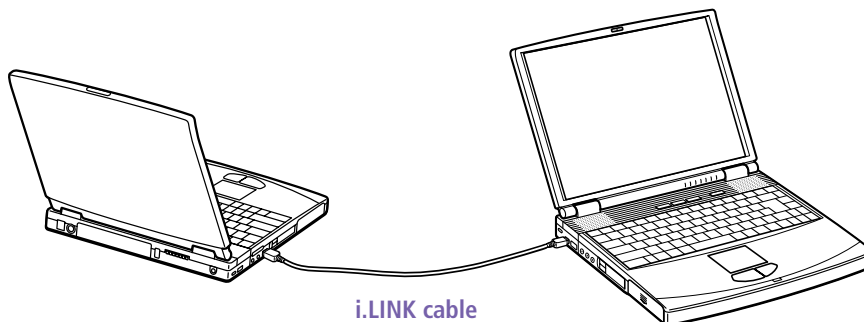

i.LINK cables compatible with your VAIO notebook computer include cables with the following part numbers: VMC-IL4415 (a 1.5-meter cable with a 4-pin connector at each end), VMC-IL4435 (a 3.5-meter cable with a 4-pin connector at each end), VMC-IL4615 (a 1.5 meter-cable with a 4-pin connector at one end and a 6-pin connector at the other), and VMC-IL4635 (a 3.5-meter cable with a 4-pin connector at one end and a 6-pin connector at the other).

Using Infrared Communication Devices

Your computer includes an infrared port, located on the left side. You can use this port to communicate with other infrared-equipped devices with compatible protocols, such as a digital still camera or other computers.

To use infrared communication with another computer

Align the infrared ports on the two computers so that they are in a direct line.

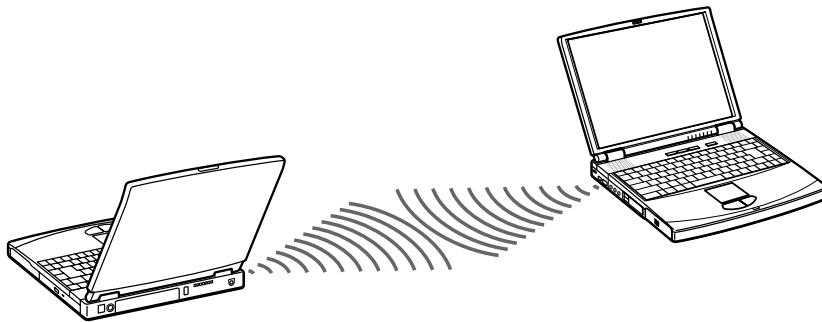

 Infrared communication capability can be turned on and off. By default, it is not enabled when your system is shipped. To enable infrared use, click the infrared icon in the Windows Control Panel and select the Enable infrared communication check box on the Options tab.

You can disable infrared communication when you are not using it to conserve battery life.

Use the infrared icon in the Windows Control Panel to enable and disable infrared communication. Do not use the icon in the taskbar.

Check the Status tag of the Infrared Monitor in the Windows Control Panel to determine if the infrared device is detected.

If the two devices are too far apart or too close together, data transfer may be interrupted or there may be noise in the transmission.

Do not cover the infrared ports with your hand or any other object.

Avoid direct sunlight, fluorescent light, or flashing incandescent light near the infrared ports.

The active area of infrared transmission extends about 39 ³/₈ inches (1 meter) with a radius of approximately 15 degrees.

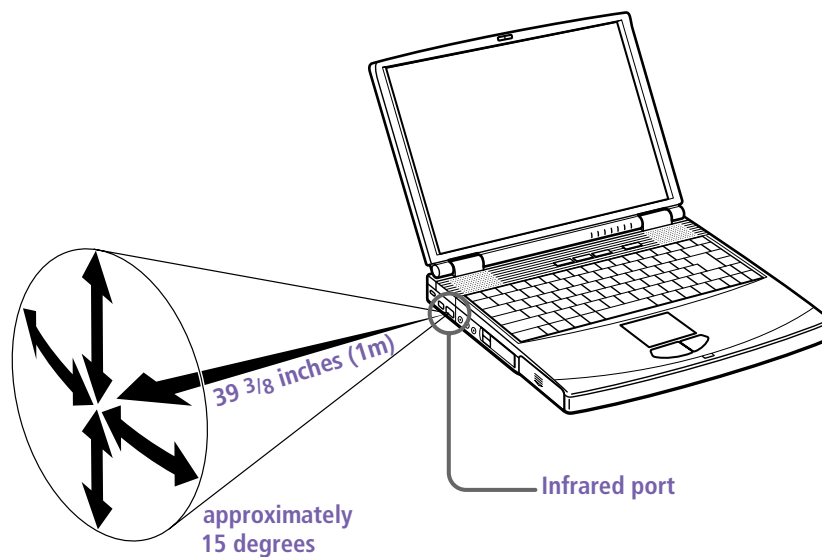

Using Power-Saving Modes

When you use a battery as the source of power for your computer, you can take advantage of power-management settings to conserve battery life. In addition to the normal operating mode, which allows you to turn off specific devices, your computer has three distinct power-saving modes: System Idle, System Suspend, and System Hibernation. When using battery power, you should be aware that the computer automatically enters System Hibernation mode when the remaining battery charge drops below five percent, regardless of the power-management setting you select.



If the battery level falls below 10 percent, you should either attach the AC adapter to recharge the battery or shut down your computer and insert a fully charged battery.

Normal Mode

This is the normal state of your computer when it is in use. The green power indicator light is on in this mode. To save power, you can turn off a specific device such as the LCD or the hard disk.

System Idle Mode

This mode is convenient if you do not need to use your computer for a brief period. The hard disk and video display enter a low power state, and the CPU clock and processor stop. The power indicator light is tan in this mode.

To activate System Idle mode

Press Fn+S, or use the PowerPanel utility.

To return to normal mode

Press any key. Note that resuming from System Idle using the touchpad or mouse is not possible. You must press a key, a PPK (see “Starting Your Favorite Software with Programmable Power Key (PPK) Setup” in the online document *Customizing Your VAIO® Notebook Computer*), or the power button.

System Suspend Mode

The computer saves the current state of the system in RAM and switches off power to the CPU. The tan power indicator light flashes in this mode.

To activate System Suspend mode

Press Fn+Esc, or press the power button and release it immediately. You can also use the PowerPanel utility to enter System Suspend mode.

To return to normal mode

Press any key.

System Hibernation Mode

The state of the system is saved on the hard drive and power is turned off. The power indicator light is off in this mode.

To activate System Hibernation mode

Press Fn+F12. The “Save to Disk Manager” screen appears, and then the computer enters System Hibernation mode. You can also use the PowerPanel utility to enter System Hibernation mode.

To return to normal mode

Turn on the computer by pressing the power button. The computer returns to its previous state.



When returning from System Hibernation mode, the system status stored on the hard disk is erased and the computer starts normally if you press the power button and hold for seven seconds.

❑ Time to return to normal mode

System Idle requires less time than System Suspend, and System Suspend requires less time than System Hibernation.

❑ Power consumption

System Idle uses more power than System Suspend, and System Suspend uses more power than System Hibernation.

Using a Second Battery Pack

You can purchase a second rechargeable battery pack. With two battery packs, you can extend the time that you use your computer with battery power. When using two battery packs, the battery pack you insert first charges first. The battery pack you insert second charges when the first battery pack is 85 percent full. You can monitor which battery pack is charging by observing the battery indicator lights.

To insert a second battery pack

- 1 If another device is in the multipurpose bay, remove the device. See “To remove the floppy disk drive” on page 24.
- 2 Insert the battery pack into the multipurpose bay.

If the battery is being used, the battery 2 indicator light turns on.

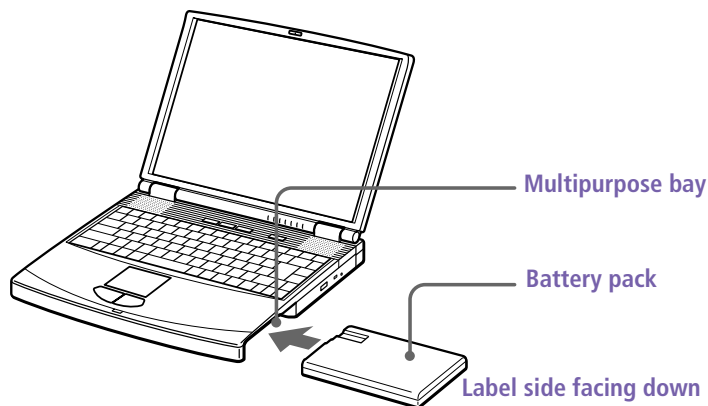

- 3 Attach the weight saver to the computer to stabilize the battery pack. There is a RELEASE lever on the bottom of the weight saver. Slide the lever toward the front of the computer to lock the weight saver. See also “Using the Weight Saver” on page 40.

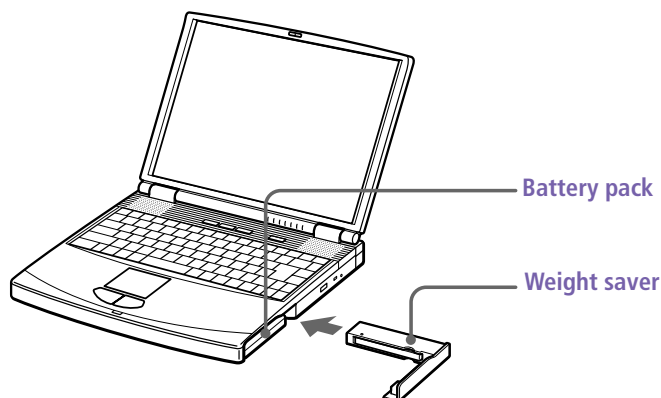

To charge the second battery pack

Keep the battery pack in the computer while it is connected to AC power. The battery indicator flashes while the battery is charging. See also “To charge the battery pack” on page 11 for more information.

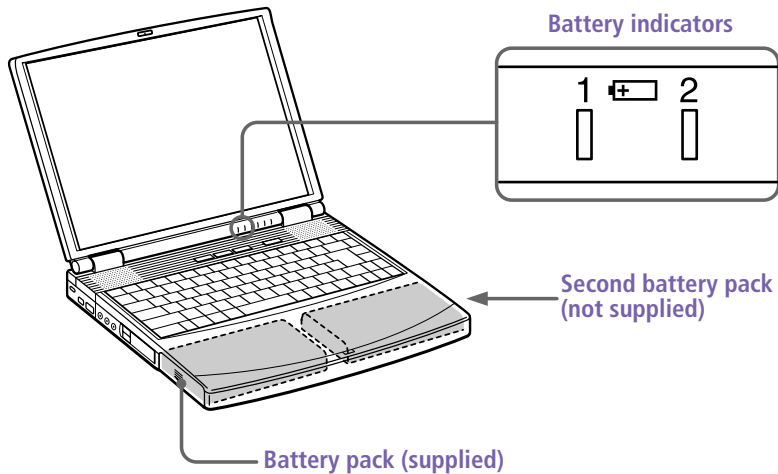

To determine the amount of time the battery lasts, see “Displaying Battery Information” in the online document *Customizing Your VAIO® Notebook Computer*.

To remove the second battery pack

If you attach two battery packs, you can remove either of them without shutting down the computer. When removing one battery pack, make sure that the other battery pack's indicator light is on. If the indicator light of the battery pack you are removing is on, right-click the battery icon on the task tray and click the "Switch discharge battery" option.

- 1 There is a Release lever on the bottom of the weight saver. To remove the battery pack, slide this lever in the direction of arrow 1, then slide the RELEASE lever on the bottom of the computer in the direction of arrow 2.

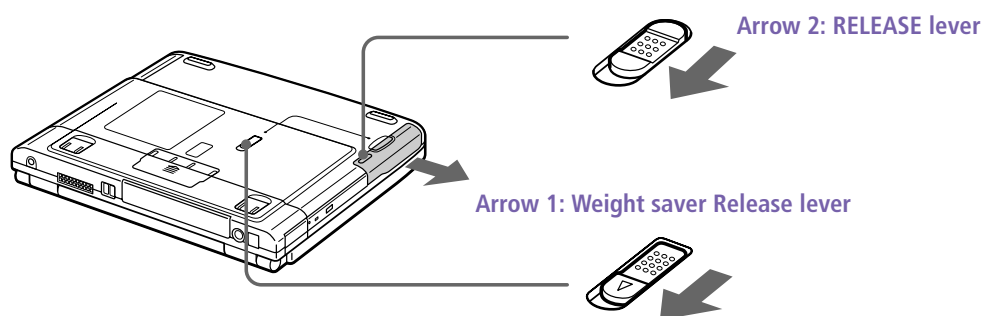

- 2 Remove the weight saver, and then pull out the battery pack.
- 3 Reinsert the weight saver. See "Using the Weight Saver" on page 40.

Using the Weight Saver

The weight saver protects the multipurpose bay when it is empty.

To attach the weight saver

- 1 If another device is in the multipurpose bay, remove the device. See “To remove the floppy disk drive” on page 24 or “To remove the second battery pack” on page 39.
- 2 Fold out the hinged arm of the weight saver and then push on the hinged arm to lock it into place. Slide the weight saver in the direction of the arrow until it clicks.

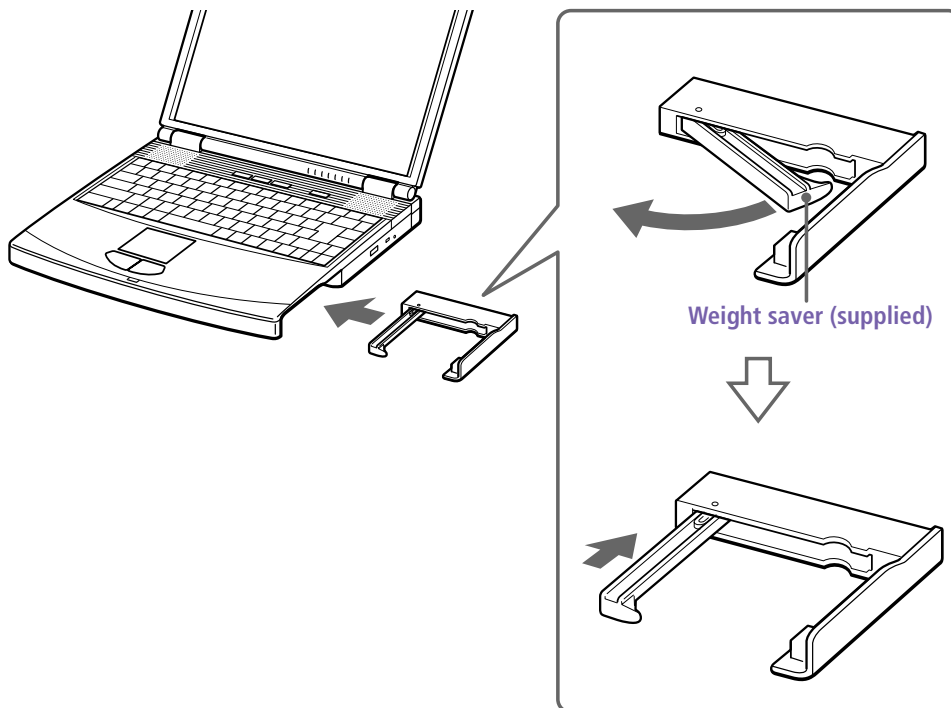

- 3 Manually lock the weight saver's Release lever.

To remove the weight saver

- 1 There is a release lever on the bottom of the weight saver. To remove the weight saver, slide this lever in the direction of arrow 1, then slide the Release lever on the bottom of the computer in the direction of arrow 2.

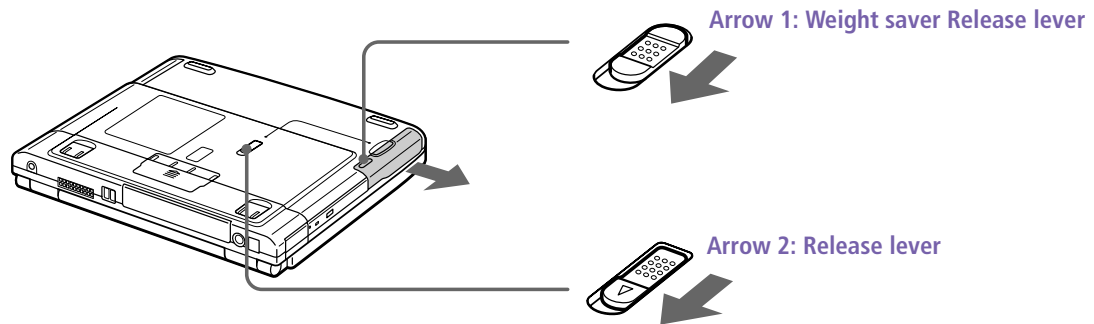

- 2 After removing the weight saver, pull out the weight saver's hinged arm and fold it into the weight saver.

Connecting Peripheral Devices

You can add functionality to your computer by connecting any of these peripherals:

- Phone line (page 44)
- Port replicator (page 45)
- Printer (page 49)
- External display (page 50)
- External mouse or keyboard (page 53)
- External speakers (page 54)
- External microphone (page 55)
- Digital still camera or other serial device (page 56)
- Digital video camera recorder (page 57)
- Universal Serial Bus (USB) device (page 58)

 Before you connect peripherals, turn off the computer and all peripherals.

You do not need to turn off your computer to connect USB devices.

Connect the power cord only after connecting all cables.

Turn on the computer only after turning on all peripherals.

Connecting a Phone Line

You need to connect a phone line to take advantage of online services and the Internet.

 In order to register your Sony VAIO notebook computer, register your software online, and use Sony Customer Support, you must connect to a phone line. You must register your computer to receive the extended warranty.

- 1 Plug one end of the phone cable into the phone line jack on the computer.

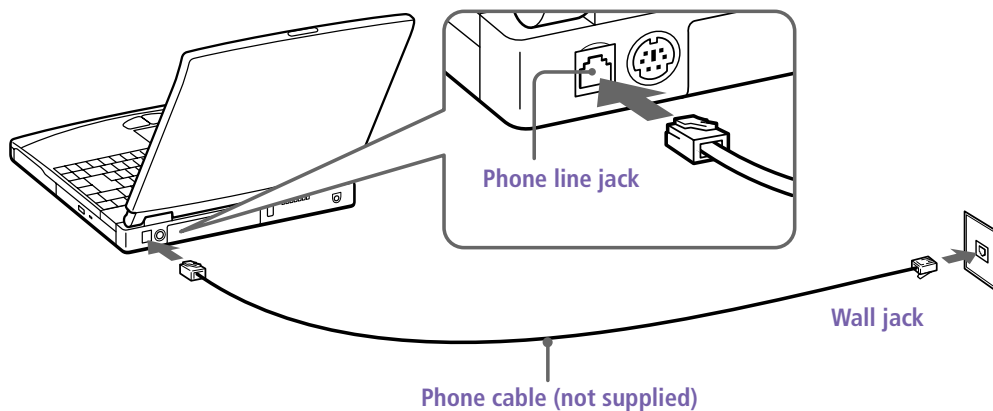

- 2 Plug the other end into the wall jack.

 Your computer does not work with party lines, cannot be connected to a coin-operated telephone, and may not work with multiple phone lines or a private branch exchange (PBX). Some of these connections may result in excess electrical current and could cause a malfunction in the internal modem.

Connecting the Port Replicator

Your notebook computer supports the use of an optional port replicator. Attaching a port replicator enables you to connect additional peripherals to your computer.

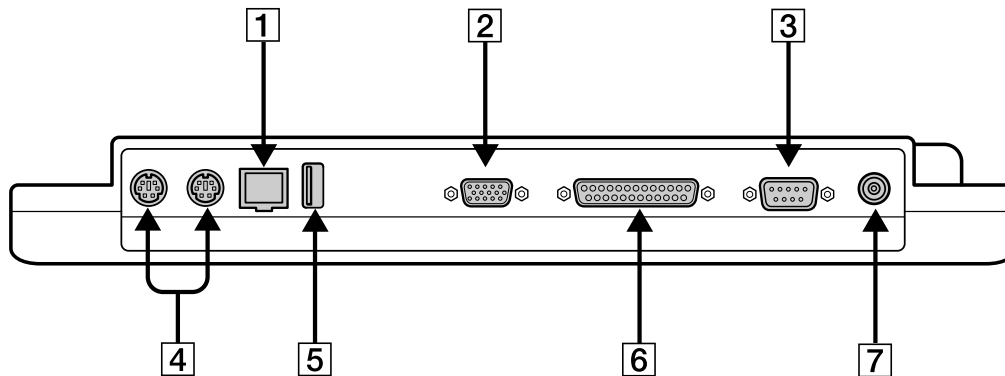

- | | | | |
|---|--|---|---|
| 1 |  Network (Ethernet) | 5 |  USB (page 58) |
| 2 |  Monitor (page 50) | 6 |  Printer (page 49) |
| 3 |  Serial (page 56) | 7 |  DC In (page 9) |
| 4 |  Mouse/Keyboard (page 53) | | |

 The port replicator can be powered only with an AC power adapter. Do not remove the AC adapter from the port replicator or the AC outlet while using the port replicator; this may cause data damage or hardware malfunctions.

When you attach your computer to the port replicator for the first time, the installation of the network driver starts automatically.

To attach your computer to the port replicator

To supply power to your computer while it is connected to the port replicator, you can connect the AC adapter directly to the port replicator.

 When attaching your computer to the port replicator, do not attempt to insert or remove the battery pack. Lifting and turning the computer with an attached port replicator could cause a temporary loss of power.

- 1 Turn off your computer and disconnect all peripherals.
- 2 On the bottom of the computer, slide the port replicator connector cover open.

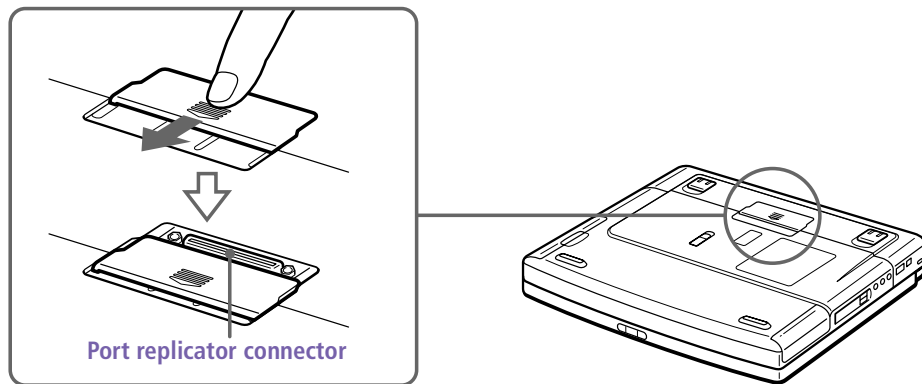

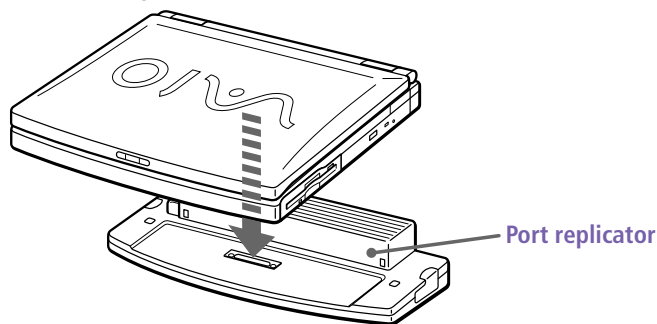

- 3 Attach the bottom of the computer to the port replicator until it clicks.

Notebook computer

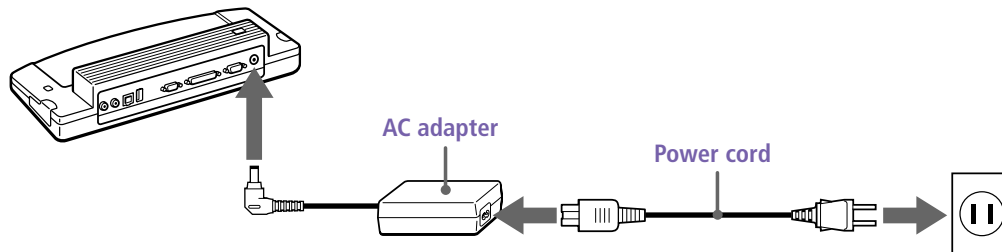

- 4 Plug the cable attached to the AC adapter into the **DC IN** connector on the port replicator. Plug the power cord into the AC adapter and an AC outlet.



 Use the AC adapter that comes with your computer or the optional Sony PCGA-ACX1 adapter.

The power indicator light turns green.

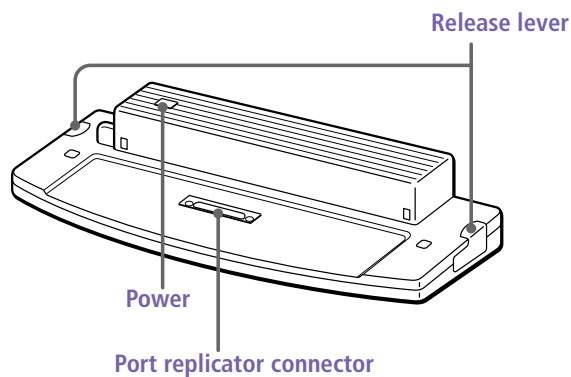

- 5 Turn on the computer.

To remove your computer from the port replicator when the power is off

- 1 Turn off your computer and the connected peripherals.
- 2 Pull the levers on each side of the port replicator to disengage the computer from the port replicator.

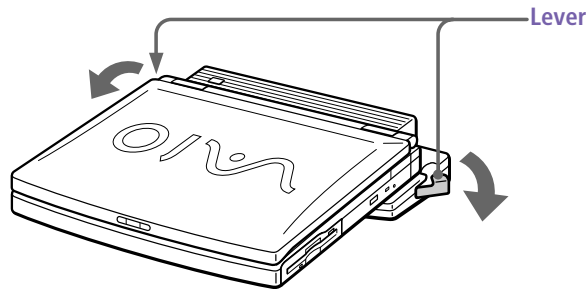

- 3 Lift the computer away from the port replicator.

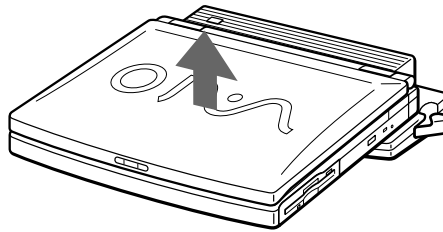

- 4 Close the port replicator connector cover on the bottom of your computer.



It is extremely important to close the port replicator connector cover after removing your computer from the port replicator. If the cover is left open, dirt may get inside and damage the computer.

Connecting a Printer

You can connect a Windows 98-compatible printer to your computer to print documents.

To connect a printer

- Use the  symbol to locate the Printer connector. Plug the printer cable (supplied with the printer) into this port on the computer.

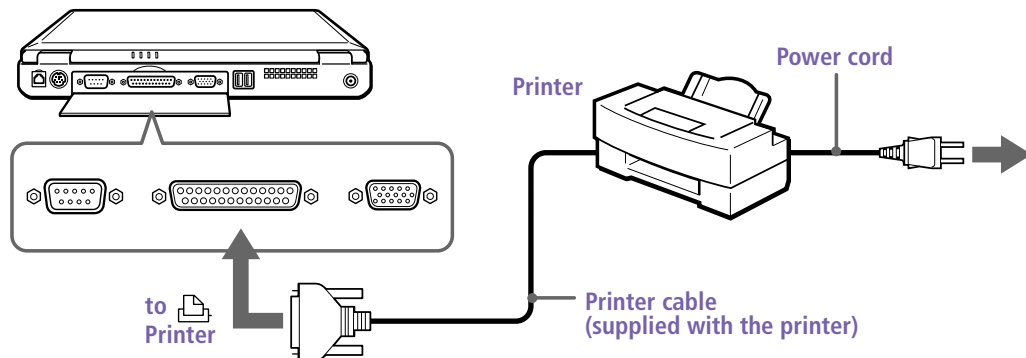

 See the manual that came with your printer for more information on installation and use.

If your printer stops functioning after resuming from a power-saving mode, see "I cannot print" on page 65.

Before using the printer, you may need to change the Printer setting in the Sony Notebook Setup software. See "Displaying the Sony Notebook Setup Screen" in the online document *Customizing Your VAIO® Notebook Computer*.

Connecting an External Display

You can connect an external display to your notebook computer. For example, you can use the computer with any of the following:

- ❑ Computer display (monitor) (page 50)
- ❑ Multimedia computer display (page 51)
- ❑ Projector (page 51)

To connect a computer display

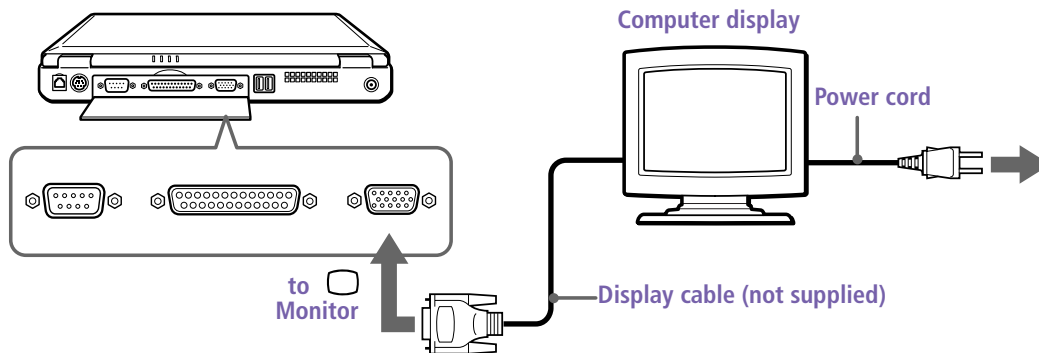

- ❑ Use the  symbol on the back of the computer to locate the Monitor connector. Plug the display cable (not supplied) into this connector on the back of the computer.
- ❑ If necessary, plug one end of the display power cord into the display, and the other end into an AC outlet.



See the manual that came with your computer display for more information on installation and use.

To connect a multimedia computer display

You can connect the notebook computer to a multimedia computer display that includes built-in speakers and a microphone.

- 1 Use the  symbol to locate the Monitor connector. Plug the display cable into this connector.
- 2 Use the  symbol to locate the Headphone connector. Plug the speaker cable into this connector.
- 3 Use the  symbol to locate the Microphone connector. Plug the microphone cable into this connector.

 See the manual that came with your multimedia computer display for more information on installation and use.

To connect a projector

You can use a projector, such as the Sony LCD Projector, as an external display.

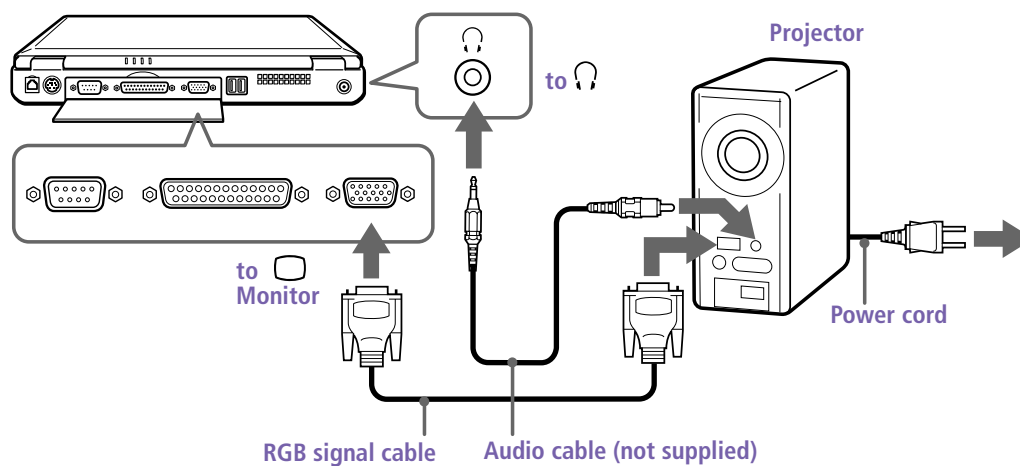

 See the manual that came with your projector for more information on installation and use.

To select a display

When you connect an external display to the monitor connector, you can toggle the output between the Liquid Crystal Display (LCD), the external monitor, or both devices.

Use the Fn+F7 keys to select a display. See also “Selecting the Display Mode” in the online document *Customizing Your VAIO® Notebook Computer* for more information.

<i>To</i>	<i>Press</i>	<i>Result</i>
Switch to an external display	Fn+F7	Toggles between the LCD, the external display connected to the Monitor connector, or both the LCD and external display.

```
graph TD; A[Only LCD] --> B[LCD and external display]; B --> C[Only external display]; C --> A;
```

Connecting an External Mouse or Keyboard

You can connect a PS/2[®]-style mouse or keyboard.

Plug the keyboard cable or mouse cable into this connector with the  mark facing up.

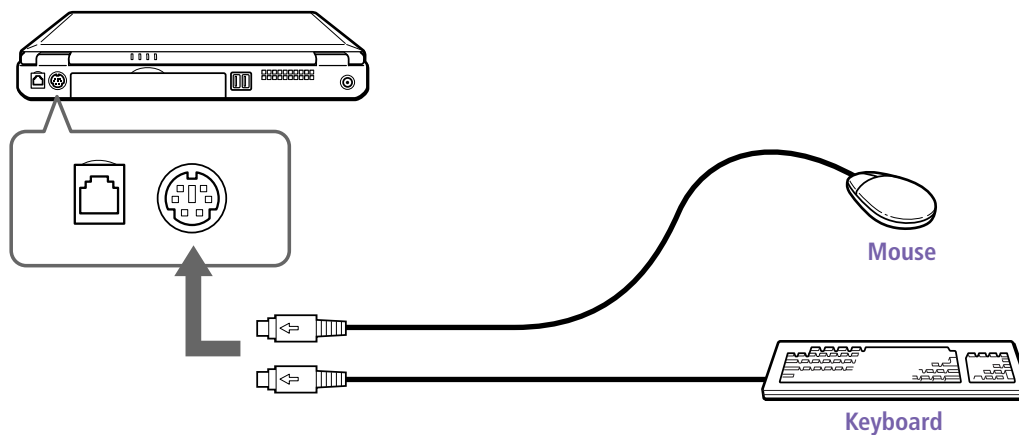

To connect both a mouse and keyboard at the same time, use the optional PS/2 division connector.



See "Using the Keyboard" on page 16 for more information on using the keyboard.

See the manual that came with your mouse or keyboard for more information on installation and use.

Before you connect or disconnect the mouse or keyboard, turn off the computer.

Do not connect or disconnect the PS/2 device (keyboard or mouse) when the computer is on. It may cause malfunction.

The Sony USB mouse PCGA-UMS1 (not supplied) is a USB device. So you must connect it to the USB connector.

Connecting External Speakers

You can enhance the sound quality of your computer by connecting external speakers.

 Make sure your speakers are designed for computer use.

Turn down the volume of the speakers before you turn them on.

Do not place diskettes on the speakers; the speakers' magnetic field may damage the data on the diskettes.

To connect external speakers

- Use the  symbol to locate the Headphone connector. Plug the speaker cable into this connector.

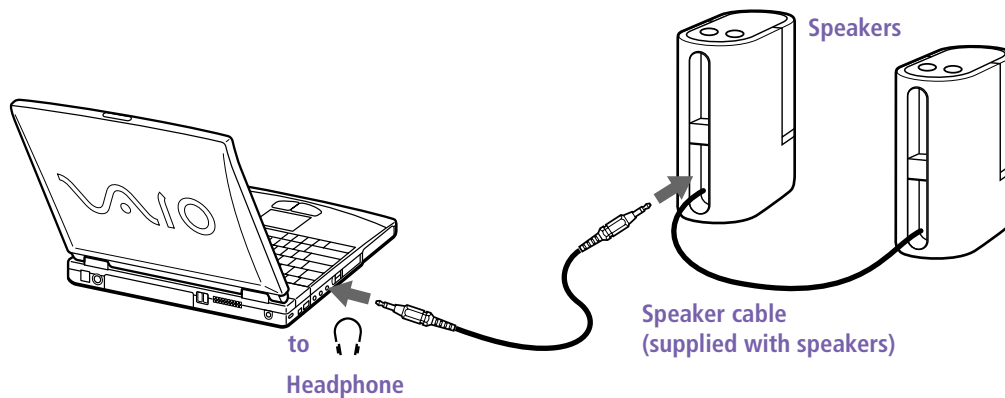

 See the manual that came with your speakers for more information on installation and use.

Connecting an External Microphone

You can enhance the quality of sound input by using an external microphone.

 Make sure your microphone is designed for computer use. The microphone should be compliant with the plug-in power microphone.

To connect an external microphone

- ❑ Use the  to locate the Microphone connector. Plug the microphone cable into this connector.

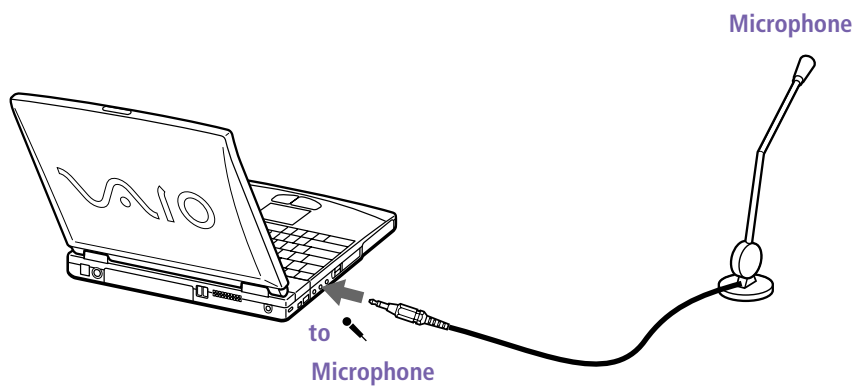



 See the manual that came with your microphone for more information on installation and use.

Connecting a Digital Still Camera or Other Serial Device

You can connect other computer peripherals, such as the Sony Digital Still Camera, to the Serial connector on your computer.

To connect a digital still camera

 If your digital video camera recorder includes a Memory Stick® Media slot, you can copy images from it to your computer via a Memory Stick card. Copy images to the Memory Stick card and insert the card into the optional Memory Stick/PC Card Adapter. Insert the adapter into the PC card slot on your computer.

- Use the  symbol to locate the Serial connector. Plug the connecting cable (not supplied) into this port on the computer and into the Digital I/O connector on the digital still camera.

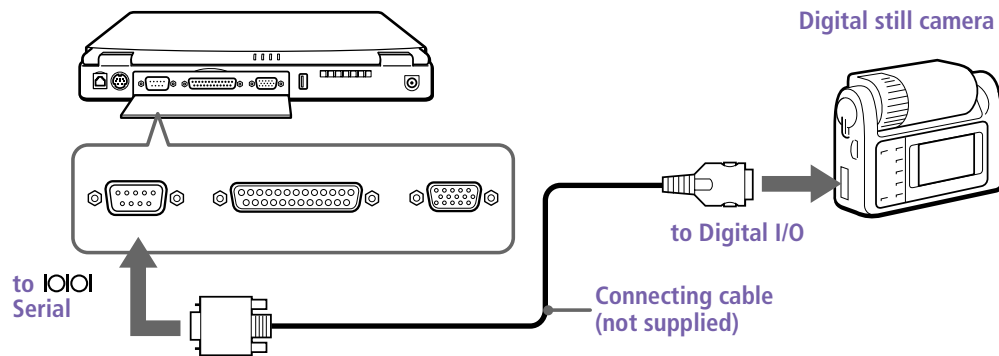

 The Sony Digital Still Camera is pictured; you may need to connect your camera differently.

See the manual that came with your digital camera or other serial device for more information on installation and use.

If you use a digital camera that has an infrared data communication system or other infrared communication device, see "Using Infrared Communication Devices" on page 33.

Connecting a Digital Video Camera Recorder

You can connect an i.LINK-enabled digital video camera recorder to the S400 i.LINK[®]  (IEEE-1394) connector.

To connect a digital video camera recorder

- ❑ Plug one end of the i.LINK cable (not supplied) into the i.LINK connector on the left side of the computer and the other end into the DV In/Out connector on the digital video camera recorder.

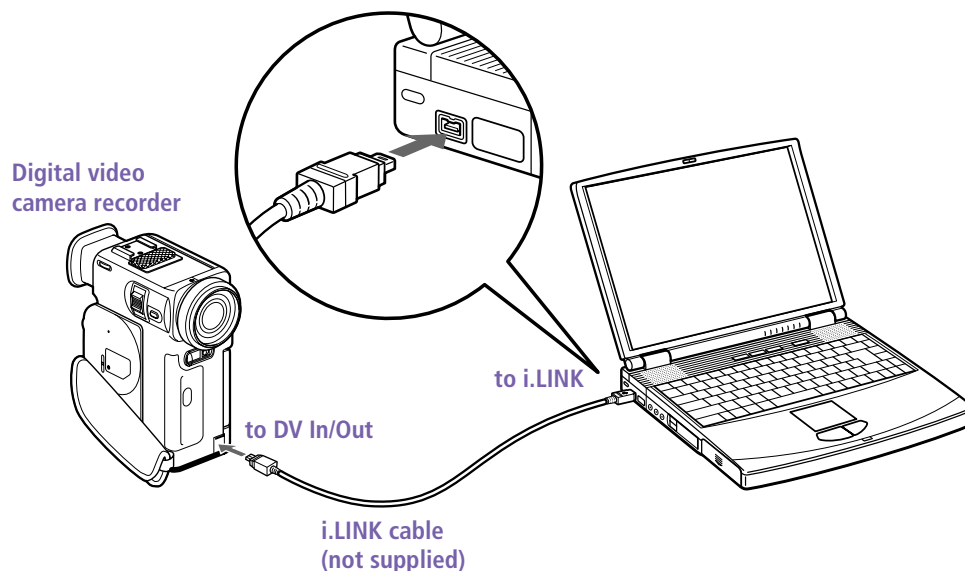

 The Sony digital video camera recorder is pictured; you may need to connect your camera differently.

On Sony digital video cameras, connectors labeled "DV In/Out" or "i.LINK" are i.LINK-compatible.

See the manual that came with your digital video camera recorder for more information on installation and use.

Do not connect more than one digital video camera at a time. The software supplied with your computer will not recognize multiple cameras.

The i.LINK connector on the computer does not supply power to external devices. If the external device requires power from the i.LINK connector, you cannot use the device with the computer.

The computer supports transfer rates up to 400 Mbps; however, the actual transfer rate is the lowest transfer rate of the external device.

The i.LINK features available may vary depending on the software applications you use. See the documentation that came with your software for more information.

Connecting a Universal Serial Bus (USB) Device

You can connect a USB device to your computer.

To connect a USB device

- Use the  symbol to locate the USB connector. Plug one end of the USB cable into this port and the other end into the USB device.

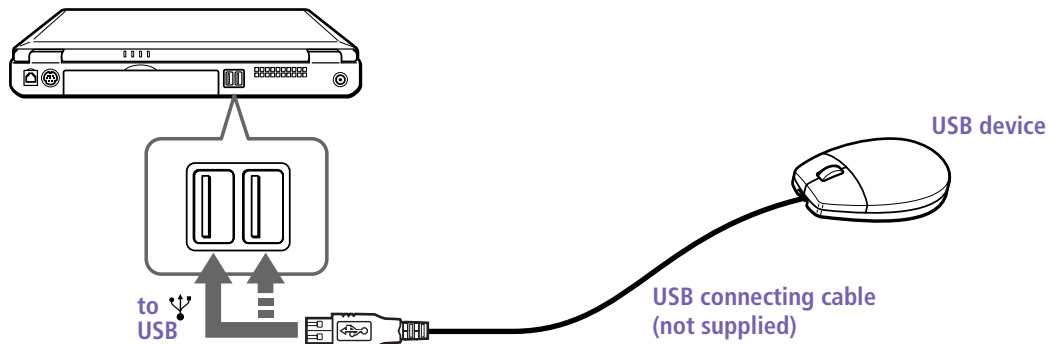

You can use the optional Sony USB mouse PCGA-UMS1 with this computer. The USB mouse software driver is preinstalled in the computer. Therefore you only need to plug the USB mouse into the USB connector.



See the manual that came with your USB device for more information on installation and use.

Troubleshooting

This section describes how to solve common problems you may encounter when using your computer. Many problems have simple solutions, so try these suggestions before you call Sony Customer Support.

 When you reconnect devices, be sure to turn off the computer as described in “Shutting Down Your Computer” on page 14. Turning off the computer using other methods may result in data loss.

My computer does not start

- Check that the computer is plugged into a power source and that it is turned on. Check that the power indicator on the front panel of the computer indicates that the power is on.
- Check that the battery packs are inserted properly and that they are charged.
- Make sure there is no diskette in the floppy disk drive.
- Confirm that the power cord and all cables are connected firmly, as described in “Connecting Peripheral Devices” on page 43.
- If you plugged the computer into a power strip or UPS, make sure the power strip or UPS is turned on and working.
- If you are using an external display, check that it is plugged into a power source and turned on. Check that the brightness and contrast controls are adjusted correctly. See the manual that came with your display for details.
- Moisture condensation may have occurred. Do not use the computer for at least one hour and then turn on the computer.
- When the internal backup battery is low on power, it may not be able to start your system properly. The message “Press <F1> to resume, <F2> to setup” would appear at the bottom of the display. Should this happen:

- 1 Press F2. The BIOS Setup menu appears.
- 2 Set the date (month/day/year). Press Enter to move to the next item. To enter 01/31/1999, for example, type 1, press Enter, type 31, press Enter, type 1999, then press Enter.
- 3 Press ↓ to select System Time, then set the time (hour: minute: second). Press Enter to move to the next item.
- 4 Press → to select Exit, then press ↓ to select Get Default Values. The message “Load default configuration now?” appears.
- 5 Check that Yes is selected, and press the Enter key. If No is selected, press ← to select Yes.
- 6 Select Exit (Save Changes), then press the Enter key. The message “Save Configuration changes and exit now?” appears.
- 7 Check that Yes is selected, then press the Enter key. The computer restarts.

When I turn on my computer, the message “Operating system not found” appears and Windows does not start

- ❑ Check the floppy disk drive to see if a nonbootable diskette is in the drive.
- ❑ If a nonbootable diskette is in the drive, turn off the computer, remove the diskette, and then turn on the computer again. Confirm that Windows starts properly. If Windows still does not start, follow the procedure below to initialize the BIOS.
- ❑ If the floppy disk drive is empty, follow the steps below to initialize the BIOS:
 - 1 Remove any peripheral devices connected to the computer.
 - 2 Turn the computer off and then turn it on again.
 - 3 Turn on the computer and press the F2 key when the Sony logo appears. The BIOS setup menu screen appears.
 - 4 Press the arrow keys to select the Exit menu.
 - 5 Press the arrow keys to select Get Default Values and then press the Enter key. The message “Load default configuration now?” appears.
 - 6 Check that Yes is selected, then press the Enter key.
 - 7 Press the arrow keys to select Exit (Save Changes) and then press the Enter key. The message “Save configuration changes and exit now?” appears.
 - 8 Check that Yes is selected, then press the Enter key. The computer restarts.

If your computer still displays the message “Operating system not found” and Windows does not start, contact Sony Customer Support.

My LCD does not display anything

- ❑ Check that the computer is plugged into a power source and that it is turned on. Check that the power indicator on the front panel of the computer is on.
- ❑ Check that the battery packs are inserted properly and that they are charged.
- ❑ The computer may be in LCD (Video) Standby mode. Press any key to activate the display.

The screen image on my external display is not centered or sized properly

Use the controls on your external display to adjust the image. See the manual supplied with your display for more information.

My computer "locks up"

- ❑ Try restarting the computer. On the Windows taskbar, click the Start button, click Shut Down, and then click Restart the computer.
- ❑ If you cannot restart as described in the preceding step, you can restart the computer by pressing Ctrl+Alt+Delete.
- ❑ If the previous step does not work, press the power button and hold it for at least four seconds. This turns off the power.
- ❑ If your computer locks up while playing a DVD-ROM/CD-ROM, stop the DVD-ROM/CD-ROM, and restart the computer by pressing Ctrl+Alt+Delete.



Pressing Ctrl+Alt+Delete may result in data loss in files that are currently open.

My software program "locks up" or crashes

Contact the software publisher or designated provider for technical support. See either the printed or the online version of *Read Me First* for a complete list of phone numbers. See the online *User Guide* for a list of technical support phone numbers.

My DVD-ROM drive tray does not open

- ❑ Make sure the computer is turned on.
- ❑ Press the Eject button on the DVD-ROM drive.
- ❑ If the Eject button does not work, you can open the tray by inserting a sharp, pointed object into the hole to the right of the Eject button.

I cannot play a CD-ROM

- ❑ Make sure the label of the CD-ROM is facing up.
- ❑ If the CD-ROM requires software, make sure the software is installed according to the program's instructions.
- ❑ Moisture condensation may have occurred. Leave the computer for at least one hour while the computer is turned on.
- ❑ Clean the CD-ROM.
- ❑ Check the speaker volume.

I cannot play a DVD-ROM

- ❑ If a region code warning appears when you are using the DVD player, it could be that the DVD-ROM you are trying to play is incompatible with the DVD-ROM drive in your notebook computer. The region code is listed on the disc's packaging.
- ❑ If you hear audio but cannot see video, your computer's video resolution may be set too high. For best results, change the Windows Control Panel/Display/Settings to 800 x 600 using 256 colors.
- ❑ If you see video but cannot hear audio, check all of the following: Make sure your DVD player's mute setting is off. Check the master volume setting in the audio Mixer. If you have connected speakers externally, check the volume settings in your computer speakers and check the connections between your speakers and the computer. Check the Windows Control Panel/System/Device Manager to see that the drivers are installed properly.
- ❑ A dirty or damaged disc may cause the computer to "hang" while it tries to read the disc. If necessary, reboot the computer, remove the disc, and then check that it is not dirty or damaged.

When I click an application icon a message appears, such as "You must insert the application CD into your CD-ROM drive," and the software does not start

- ❑ Some titles require specific files that are located on the application's CD-ROM. Insert the disc and try starting the program again.
- ❑ Make sure you place the disc in the tray with the label side facing up.

My floppy disk drive cannot write to a diskette

- ❑ If the diskette is write-protected, disable the write-protect feature or use a diskette that is not write-protected.
- ❑ Check that the diskette is properly inserted into the floppy disk drive.

My speakers have no sound

- ❑ If the built-in speakers are turned off, press Fn+F3 to turn on the speakers.
- ❑ If the speaker volume is turned to the minimum, press Fn+F4, and then press ↑ or → to increase the volume.
- ❑ If your computer is powered by batteries, check that the battery packs are inserted properly and that they are charged.
- ❑ If you are using an application that has its own volume control, check that the volume is turned up.
- ❑ Check the volume controls in Windows 98.
- ❑ If you connect external speakers, check that the speakers are properly connected and the volume is turned up. If the speakers have a mute button, make sure it is off. If the speakers are powered by batteries, check that the batteries are inserted properly and that they are charged.
- ❑ If you have connected an audio cable to the Headphone connector, disconnect the cable.

My modem does not work

- ❑ Check that the phone line is plugged into the line jack. See “Connecting a Phone Line” on page 44 for details.
- ❑ Check that the phone line is working. You can check the line by plugging in an ordinary phone and listening for a dial tone.
- ❑ Check that the phone number the program is dialing is correct.
- ❑ Check that the software you are using is compatible with the notebook computer modem. (All preinstalled programs are compatible.) Call the software publisher or Sony Customer Support.

My modem connection is slow

The computer's modem uses V.90 technology. Many factors influence modem connection speed, including telephone line noise or compatibility with telephone equipment (such as fax machines or other modems). If you think your modem is not connecting properly to other PC-based modems, fax machines, or your Internet Service Provider, check the following:

- ❑ Have your phone company check that your phone line is free from any line noise.

- ❑ If your problem is fax-related, check that there are no problems with the fax machine you are calling and that it is compatible with fax modems.
- ❑ If you are having a problem connecting with your Internet Service Provider (ISP), check that the ISP is not experiencing technical problems.
- ❑ If you have a second phone line available, try connecting the modem to that line.

My microphone does not work

If you are using an external microphone, check that the microphone is plugged into the Microphone connector. See “Connecting an External Microphone” on page 55 for details.

My mouse does not work

- ❑ If you are using an external mouse, check that the mouse is plugged into the mouse connector. See “Connecting an External Mouse or Keyboard” on page 53 for details.
- ❑ If you connected an external mouse while your computer is on, you must restart your computer.
- ❑ If you are using an optional Sony USB mouse PCGA-UMS1, check that the mouse is plugged into the USB connector.

My touchpad does not work

You may have disabled the touchpad while no mouse was connected to the computer. If so, you must restart the computer to make the touchpad work again.

I cannot use DV devices. The message “DV equipment seems to be disconnected or turned off” appears.

- ❑ Check that the DV device is turned on and that the cables are properly connected.
- ❑ If you are using multiple i.LINK® devices, the combination of the connected devices may cause unstable operation. In this case, turn off the power to all connected devices and disconnect unused devices. Check the connection, then turn on the power again.

My touchpad interprets a single tap as a double-click

Click the Mouse icon in the Control Panel and then change the button assignments in the Mouse Properties dialog box. One of the buttons is assigned to the double-click action.

My computer does not shut down

It is best to shut down your computer using the Shut Down command on the Windows 98 Start menu. Using other methods, including those listed here, may result in loss of unsaved data. If the Shut Down command does not work properly, follow these steps:

- ❑ Restart the computer by pressing Ctrl+Alt+Delete. If this does not work, press the power button and hold it for at least four seconds to turn off the power.
- ❑ Unplug the computer from the AC adapter and remove the battery pack from your computer.

My PC card is not working

- ❑ Make sure the PC card is compatible with Windows 98.
- ❑ Use the Sony Notebook Setup utility to disable devices you are not currently using.

The sound of my computer's fan is too loud

Use the PowerPanel utility to change the Thermal Control Strategy setting to Quiet. This setting slows down the CPU fan speed. See the PowerPanel Help for more information.

I cannot print

- ❑ The default setting for the printer port mode is correct for most printers. If you cannot print, try changing the printer port mode. In Sony Notebook Setup, select the Printer tab. If the printer port mode is set to ECP, change it to bidirectional. If the printer port mode is set to bidirectional, change it to ECP. See “Displaying the Sony Notebook Setup Screen” in the online document *Customizing Your VAIO® Notebook Computer* for details on using Sony Notebook Setup.
- ❑ Your connected printer may not function after the computer resumes from a power-saving mode. When this occurs, follow the procedures below to reset the printer connection:
 - 1 Right-click the My Computer icon on the desktop, and then select Properties.
 - 2 Click the Device Manager tab.
 - 3 Select Refresh, and then click OK. The printer should now function properly.

Power Management

The operating system may become unstable if a lower power state such as system hibernation is initiated and then changed before the operating system completely enters the lower power state. To restore the computer to its normal operating stability, close all open applications, press the power button, and hold it for four seconds or more to completely shut down the computer.

Changing the Window Design of Sony Software

To change the window design of Sony software:

- 1 Click the Start button, point to Settings, and then click Control Panel.
- 2 Double-click UI Design Selector.
- 3 Click <<or>> and select the desired design.
- 4 Click Apply. The UI Design Selector window design changes. The window design for your software will match the UI Design Selector window.
- 5 To choose another selection, click <<or>>.
- 6 Click OK. The UI Design Selector closes and the window design of your Sony software displays.

Using the System Recovery and Application Recovery CDs

The following sections describe how to use the System Recovery and Application Recovery utilities.

Using the System Recovery CD(s)

You can reinstall software titles that shipped with your computer if they are corrupted or accidentally erased. You may not need to recover the entire contents of your hard drive. If you experience a problem with your computer, reinstalling an individual device driver or software title may correct the problem. Use the Application Recovery CD(s) to reinstall individual applications or device drivers. See “Using the Application Recovery CD(s)” on page 70.

The System Recovery CD contains a backup copy of all the software originally installed on your hard disk drive. **It can be used only to recover the hard disk of the notebook computer you purchased.**

The System Recovery utility gives you three options:

- ❑ **Full Restore without Format** restores all the software titles that originally came with your computer without formatting the hard disk.
- ❑ **Full Restore with Format** formats the hard disk drive and then restores all the original software. If your hard drive is partitioned into C and D drives, the computer offers you the option to reformat the drive into a single partition.
- ❑ **Operating System Only** restores the Windows® 98 Second Edition operating system, the notebook computer utility programs, and the device drivers that shipped with your computer.

! If you choose the Full Restore with Format or Operating System Only option, your hard disk will be formatted, which removes all the information on the hard disk drive. You will lose any software you have installed and any other files you have created since you started to use your computer. This means you will have to reinstall any applications that were not included with the computer when you purchased it. If you choose the Full Restore without Format option, you may need to reinstall applications that were not included with the computer when you purchased it. If you have any questions on using the System Recovery CD, contact Sony Customer Support.

To use the System Recovery CD(s)

 You need to complete the Microsoft Windows 98 registration process when you use the System Recovery CD. Make sure you have the product ID number located on the cover of your Microsoft Windows 98 *Getting Started* manual. You will need this number to complete the recovery process.

1 Insert the Sony System Recovery CD in the DVD-ROM drive.

 The System recovery utility boots from the DVD-ROM drive. It must be in the DVD-ROM drive when you turn on the computer.

2 Shut down your computer as described in “Shutting Down Your Computer” on page 14.

3 Wait four seconds and turn on your computer.

4 Click OK to signify you have read and accept the Microsoft End-User License Agreement.

5 When the System Recovery menu appears, follow the on-screen instructions to complete the recovery process.

 Your system may include one or two System Recovery CDs. If you have two System Recovery CDs, insert the first CD to run the System Recovery program. You are prompted to insert the second CD once the information from the first CD has been installed.

The recovery process takes 30 to 60 minutes to complete.

If your computer does not start from the Recovery CD

1 Press the power button and hold it for more than four seconds to turn off the computer.

2 Turn on the computer. When the Sony logo is displayed, press the F2 key. The BIOS setup menu screen appears.

3 Press the arrow keys to select the Exit menu.

4 Press the arrow keys to select Get Default Values and then press the Enter key. The message “Load default configuration now?” appears.

- 5 Check that Yes is selected, then press the Enter key.
- 6 Press the arrow keys to select Exit (Save Changes) and then press the Enter key. The message “Save configuration changes and exit now?” appears.
- 7 Check that Yes is selected, then press the Enter key. The computer restarts from the Recovery CD.

Using the Application Recovery CD(s)

The Application Recovery CD(s) allows you to reinstall individual applications and device drivers if they are corrupted or accidentally erased. Reinstalling an individual device driver or software title may correct a problem you are experiencing with your computer, and you may not need to recover the entire contents of your hard drive. If you do need to reinstall all the software titles that shipped with your computer, use the System Recovery CD(s). See “Using the System Recovery CD(s)” on page 68.

You can also use the Application Recovery CD to install Windows NT® Workstation 4.0 drivers on your computer.



You must be in Windows to run the Application Recovery CD. The application will not run from MS-DOS®. If you have any questions on using the Application Recovery CD, contact Sony Customer Support.

To use the Application Recovery CD(s)

- 1 Turn on your computer. If your computer is already on, close all applications.
- 2 When the Windows desktop appears, insert the Sony Application Recovery CD in the DVD-ROM drive. The Application Recovery utility loads automatically.
- 3 When the Application Recovery menu appears, select the icon for the application you want to restore and then follow the on-screen instructions to complete the recovery process.



Your system may include one or two Application Recovery CDs. If you have two Application Recovery CDs, insert the first CD to run the Application Recovery program. You may be prompted to insert the second CD, depending on the application you wish to restore.

About the Software on Your Computer

Your VAIO notebook computer is ready to help you work, play, learn, and communicate as soon as you turn it on. This section gives you an overview of the activities you can perform with your software titles. For support information, see “For Answers to Your Software Questions” on page 76.

Adobe Acrobat® Reader

Adobe Systems Inc.

Acrobat Reader software allows you to view, navigate, and print electronic documents in Adobe Portable Document Format (PDF), an open file format that is intended to preserve the fidelity of documents created on all major computer platforms.

Adobe PhotoDeluxe® Business Edition

Adobe Systems Inc.

Create amazing photo effects with Adobe PhotoDeluxe. Without learning complex software, you can enhance, restore, and be creative with your photos. Includes built-in guided activities, stock photos, clip art and templates to assist you.

America Online®

America Online

America Online is a popular Internet online service. Stay in touch with family and friends with easy-to-use e-mail, manage your personal finances, get the latest news and sports scores, and chat with thousands of others who share your interests.

AT&T WorldNet® Service

AT&T

Fast, reliable Internet access from AT&T WorldNet Service. AT&T WorldNet Service provides Web-based e-mail, a personalized start page from Excite,SM easy access to the Excite search engine, free Web pages, online and live agent technical support, instant messaging, and special shopping discounts at Market Square.

CompuServe® 2000

CompuServe, Inc.

CompuServe is the most comprehensive source of organized business and educational information online today. CompuServe allows you to access the vastness of the Internet, without wasting time wading through it. Maximize your time online with CompuServe.

DVgate™ Still*Sony Electronics*

Connect a digital video camera recorder to the i.LINK® connector and capture your own still images. You can save your images in a variety of popular file formats.

DVgate™ Motion*Sony Electronics*

Connect a digital video camera recorder to the i.LINK connector and capture your own video images. You can edit clips from your video, add others, and combine clips into new movie segments.

EarthLink Network TotalAccess™*EarthLink Network, Inc.*

An Internet Service Provider that supplies access, information, and assistance to its customers, introducing them to the Internet. Member benefits include e-mail, newsgroups, a personal start page, a free 6 MB Web site, a member newsletter, and 24-hour technical support.

McAfee VirusScan®*Network Associates, Inc.*

Protect your computer from viruses. VirusScan can detect viruses from floppy disks, Internet downloads, e-mail attachments, intranets, shared files, CD-ROMs, and online services.

Media Bar™*Sony Electronics*

Media Bar software is your all-in-one solution for audio/video playback. Media Bar software handles all common computer multimedia formats and controls selected Sony devices. In addition to audio/video library cataloging and playlist management, Media Bar software includes digital video quality control and effects features. Media Bar software seamlessly integrates a variety of new media formats with an easy-to-use software interface.

Microsoft® Internet Explorer for Windows® 98*Microsoft Corporation*

Internet Explorer delivers the Web the way you want it. It is safe, easy to use, and you can personalize how you access the Web. Outlook Express and other tools in Internet Explorer also help you have a great experience when you are on the Web.

Microsoft® Outlook® Express*Microsoft Corporation*

Outlook Express, the messaging tool that takes your e-mail and newsgroup communication to new heights! Outlook Express is easy to set up and use, and provides you with secure, personalized, and complete features that make creating, sending, and reading your e-mail a more rich and dynamic experience.

Microsoft® Word 2000*Microsoft Corporation*

Microsoft Word 2000 makes it easy to create common Web, e-mail, and print documents for use around the world. It embraces HTML as a first-class file format and extends Word's ease-of-use to the Web and e-mail. Word 2000 also extends that ease of use to international users, making it easy to create multilingual documents.

Netscape Communicator®*Netscape Communications*

Netscape Communicator is an all-in-one Internet tool that makes it easy to browse the Web, send Internet e-mail, chat, read newsgroups, and compose great Web documents.

PictureGear™*Sony Electronics*

This image management software displays images from your hard drive, a Sony digital still camera, or a Sony Mavica® camera. The images appear in a convenient light-table format, so that you can easily view the contents of an entire folder.

Prodigy Internet™*Prodigy Communications Corporation*

An online service that helps you find what you need online faster and smarter. Prodigy delivers powerful online content such as sports scores, stock quotes, news, and easy access to Excite, plus quality customer service — all at a competitive price.

Quicken® Basic 99*Intuit, Inc.*

Quicken is a fast, easy way to organize your finances. Quicken works just like your checkbook, so it is easy to learn and use. Quicken manages all your finances, bank accounts, credit cards, investments, and loans. You can even pay your bills online.

Smart Capture

Sony Electronics

Smart Capture is a fun new way to send multimedia messages via e-mail. Smart Capture manages the i.LINK connection between your computer and a Sony Digital Handycam® Camcorder that supports the i.LINK interface. It allows you to capture compressed video or still images that you can save or share via e-mail. A smart solution to computer, digital audio/video, and network convergence.

Smart Connect

Sony Electronics

Smart Connect allows you to use an i.LINK cable to connect your VAIO computer to another VAIO computer that supports Smart Connect. You can then use one computer to copy, delete, and edit files on the other computer. You can also print from a printer attached to either computer.

Smart Label

Sony Electronics

This tool allows you to record your voice and play it back at any time to remind you of important information, such as telephone numbers or appointments. It can also be used as a normal text memo pad. It can record a voice memo up to 60 seconds long. You can combine this with pictures and/or text to create a memo that you can place on your computer desktop.

Smart Pad

Sony Electronics

Smart Pad enables you to record handwritten information such as text, symbols, simple maps, and drawings.

Smart Publisher

Sony Electronics

Smart Publisher makes it easy for you to send Web pages to the Internet, using e-mail or FTP.

Smart Write

Sony Electronics

A word processor that allows you to create documents that incorporate pictures and sound. With Smart Write, you can record your voice right into the page and draw directly onto your documents with a computer “pencil.”

WinFax® Basic Edition

Symantec Corporation

WinFax Basic incorporates an easy-to-use interface that allows you to send and receive faxes easily. Upgrade to WinFax Pro to receive additional features.

About Your Recovery CDs

Application Recovery CD(s)

Sony Electronics

This program allows you to reinstall individual applications and device drivers. Use it to restore corrupted or accidentally erased files.

System Recovery CD(s)

Sony Electronics

This program allows you to restore the software titles that shipped with your computer if they become corrupted or are erased accidentally. It can be used only to restore the hard disk of this Sony computer.

For Answers to Your Software Questions

Acrobat® Reader, Adobe PhotoDeluxe® Business Edition (Adobe Systems Incorporated)

Web site	http://www.adobe.com/
phone	206-628-2746 (fee-based support)
fax	206-628-5737
e-mail	techdocs@adobe.com
hours	M-F, 6 AM-5 PM PT

America Online® (America Online)

Web site	http://www.aol.com/
phone	800-827-3338
hours	7 days a week, 24 hours a day

AT&T WorldNet® Service (AT&T)

Web site	http://www.worldnet.att.net
phone	800-400-1447
e-mail	worldnet@attmail.com
hours	7 days a week, 24 hours a day

CompuServe® 2000 (CompuServe, Inc.)

Web site	http://www.compuserve.com/
phone	800-848-8990
hours	M-F, 8 AM - 1 AM ET, S-S 10 AM - 10 PM ET

EarthLink Network® (EarthLink Network, Inc.)

Web site	http://help.earthlink.net/techsupport/
phone	800-395-8410
e-mail	support@earthlink.net
hours	7 days a week, 24 hours a day

McAfee VirusScan® (Network Associates, Inc.)

Web site	http://support.mcafee.com
phone	408-988-3832
e-mail	cybr@nai.com
hours	M-F 9AM-5PM Central Time

Netscape Communicator® (Netscape Communications Corporation)

Web site	http://www.netscape.com/
phone	888-4SONYPC (888-476-6972)*
hours	7 days a week, 24 hours a day

* Support from 1-888-4SONY PC is free of charge for 90 days after the original date of purchase.

Prodigy Internet™ (Prodigy Communications Corporation)

Web site	http://www.prodigy.com/
phone	800-213-0992
hours	7 AM - 3 AM ET

Quicken® Basic (Intuit Inc.)

Web site	http://www.intuit.com/support/
phone	900-555-4688
hours	7 days a week, 24 hours a day

Windows 98 Operating System, Word, Internet Explorer, Outlook Express (Microsoft Corporation)

Web site	http://www.microsoft.com/support/
phone	888-4SONYPC (888-476-6972)*
hours	7 days a week, 24 hours a day

* Support from 1-888-4SONY PC is free of charge for 90 days after the original date of purchase.

Sony Service Center

For the Sony Service Center nearest you, call 1-888-4SONYPC (1-888-476-6972).

Adding Memory

In the future you may want to install memory modules to expand the functionality of your computer. You can increase memory up to 256 MB (128MB x 2), by installing optional memory modules; 64 MB of memory are already installed (64MB x 1). You can add an expansion memory module in a slot. Up to 128 MB expansion memory modules are available as optional memory modules.

 The size of your memory may differ if you purchased a specially configured system.

! Make sure you observe the proper safety precautions when you install memory modules in your computer. See the bulleted list below. Be careful when adding memory. Mistakes when installing or removing a memory module may cause a malfunction.

- ❑ The procedures described below assume familiarity with the general terminology associated with personal computers and with the safety practices and regulatory compliance required for using and modifying electronic equipment.
- ❑ Disconnect the system from its power source and from any telecommunications links, networks, or modems before you open the system or follow any of the procedures described below. Failure to do so may result in personal injury or equipment damage.
- ❑ Electrostatic discharge (ESD) can damage memory modules and other components. Perform the procedures described below only at an ESD workstation. If such a station is not available, do not work in a carpeted area, and do not handle materials that produce or hold static electricity (cellophane wrappers, for example). Ground yourself by maintaining contact with an unpainted metal portion of the chassis while performing the procedure.
- ❑ Do not open the memory module package until you are ready to install the module. The package protects the module from ESD.

- ❑ Use the special bag for preventing ESD or use aluminum foil when you store the memory module.

Typical expansion memory configuration

Total System Memory (MB)	Slot 1 (MB)	Slot 2 (MB)
64 [†]	64	0
128	64	64
192	64	128
256	128	128

[†] 64 MB is the default memory amount.

To remove a memory module

- 1 Shut down your computer and disconnect all peripheral devices, such as your printer.
- 2 Unplug the computer and remove the battery packs.
- 3 Wait until the computer cools down. Then unscrew the screw at the bottom of your computer. Loosen the screw with an appropriate screwdriver.

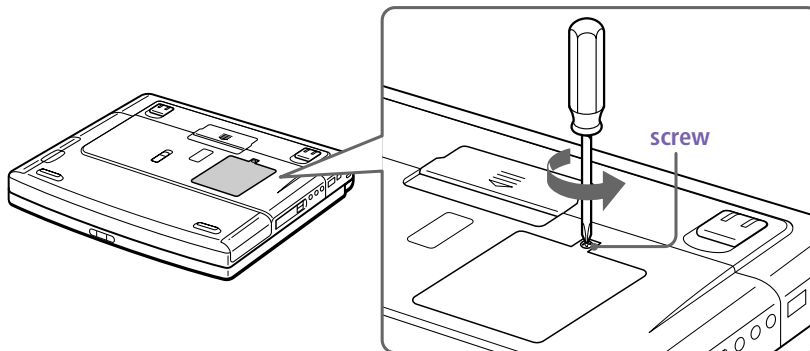

- 4 Touch a metal object (such as the connector panel on the back of your computer) to discharge static electricity.
- 5 Remove the memory module.

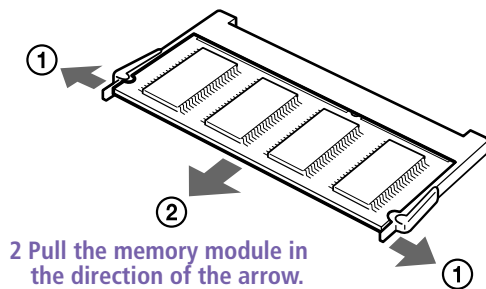

2 Pull the memory module in the direction of the arrow.

1 Pull the tabs in the direction of the arrows. The memory module is released.

6 Tighten the screw on the bottom of the computer.

 Your computer comes with a memory module installed in the memory slot. To upgrade your memory you will need to remove this module from the slot before installing your upgrade memory.

To install a memory module

- 1 Follow steps 1 to 4 of “To remove a memory module.”
- 2 Remove the memory module from its packaging.
- 3 Install the memory module.

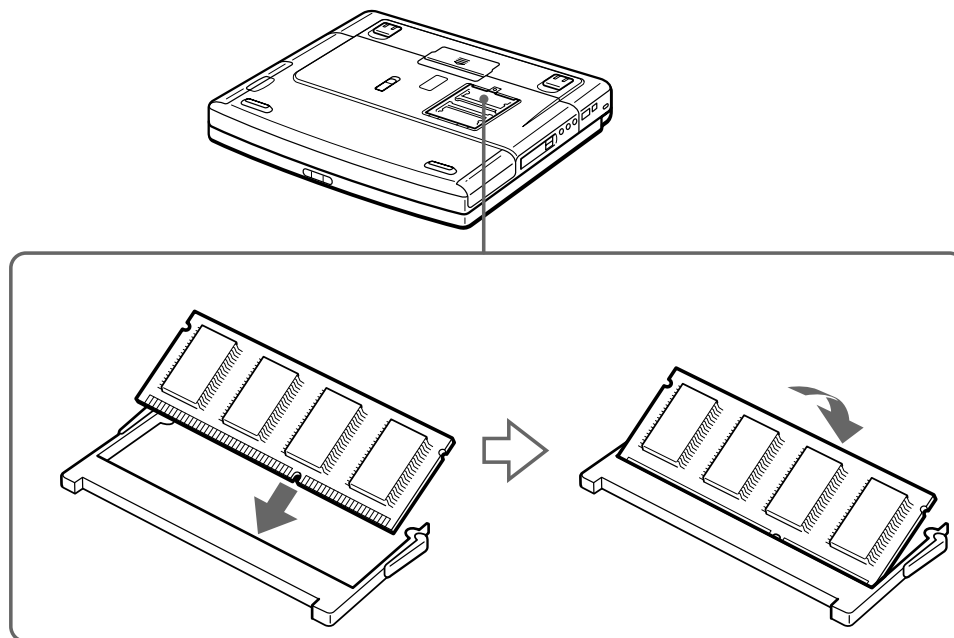

1 Slide the memory module into the slot.

2 Press the module into place until it clicks.

4 Tighten the screw on the bottom of the computer.

To view the amount of memory

- 1 Turn on the computer.
- 2 Click the Start button, point to VAIO, and click “Sony Notebook Setup.” The Sony Notebook Setup screen appears.
- 3 Click the “About This Computer” tab to view the amount of system memory. If the additional memory is not shown, repeat steps 1-4 in “To install a memory module.”

Specifications

Model	PCG-F430	PCG-F450
Processor	450 MHz* Pentium III	500 MHz* Pentium III
Hard Disk Drive	6.0 GB [†]	9.0 GB [†]
Standard RAM	64 MB SDRAM, expandable to 256 MB	64 MB SDRAM, expandable to 256 MB
LCD Screen	14.1" XGA TFT	14.1" XGA TFT
L2 Cache Memory	256 KB (on die)	256 KB (on die)
MPEG	MPEG2 Digital Video; supports full-screen playback	
Graphics	128-bit accelerator with 2.5 MB Video RAM	
Sound Capabilities	16-bit CD-quality stereo sound	
Diskette Drive	Removable 3.5" 1.44 MB	
DVD-ROM Drive	Reads CD data from 10.3X to 24X variable transfer rate. [‡] Reads DVD data from 1.7X to 4X variable transfer rate.**	
Laser Diode Properties	DVD-ROM drive wave length 780 nm and 650 nm; laser output 4.59 μW	
Modem	K56flex™ technology/V.90 compatible modem ^{††}	
Infrared	Supports 4 Mbps, 1.1 Mbps, and 115 Kbps IrDA Standard	
Drive Bay	Supports floppy disk drive (included) Supports second rechargeable battery (optional)	
Expansion Capabilities	Type II PC cards and Type III PC card Card Bus support	
Built-in Capabilities	Microphone Stereo speakers Digital touch pad	
Telecommunication Capabilities	Data and fax send/receive ^{††}	
Connection Capabilities	2 USB Ports i.LINK Serial Port Keyboard/mouse (PS/2®-style) VGA Monitor Video out Parallel (printer) Phone line (RJ-11) Microphone Headphone Port Replicator	
Supplied Accessories	Video cable Floppy disk drive Rechargeable battery AC adapter and power cord Weight Saver	
Service	90-day limited express service ^{†††} Extendible to one year from original date of purchase upon registration	

<i>Model</i>	<i>PCG-F430</i>	<i>PCG-F450</i>
<i>Limited Warranty</i>	90-day parts/labor standard ^{††} Extendible to one year from original date of purchase upon registration	
<i>Power Requirements</i>	49.5 watts maximum (19.5V DC/AC 120-240V)	
<i>Power Management</i>	Energy Star compliant Advanced Configuration and Power Interface (ACPI)	
<i>Battery</i>	Lithium-ion, supports dual battery operation	
<i>Dimensions</i>	12.8" (w) x 1.8" (h) ^{***} x 10.5" (d) (324 x 46.9 x 265.5 mm)	
<i>Weight</i>	6.8 lbs. (3.1 kg) (with battery and weight saver) 7.3 lbs. (3.3 kg) (with battery and floppy disk drive)	
<i>Operating Temperature</i>	41° F to 95° F (+5° C to 35° C) temperature gradient less than 18° F (10° C) per hour	
<i>Operating Humidity</i>	20% to 80% (not condensed), provided that humidity is less than 65% at 95° F (35° C), hygrometer reading of less than 84° F (29° C)	
<i>Storage Temperature</i>	-4° F to 140° F (-20° C to 60° C), temperature gradient less than 18° F (10° C) per hour	
<i>Storage Humidity</i>	10% to 90% (not condensed) provided that humidity is less than 20% at 140° F (60° C), hygrometer reading of less than 95° F (35° C)	

* MHz denotes microprocessor internal clock speed; other factors may affect application performance.

† The size of your hard disk may differ if you purchased a specially configured system. GB means one billion bytes when referring to hard drive capacity. Accessible capacity may vary.

‡ Data on a CD-ROM disc is read at a variable transfer rate, ranging from 10.3X at the innermost track to 24X at the outermost track (the data transfer standard 1X rate is 150 kbytes/s). The average data transfer rate is 17.2X or 2580 kbytes/s.

** Data on a DVD-ROM disc is read at a variable transfer rate, ranging from 1.7X at the innermost track to 4X at the outermost track (the data transfer standard 1X rate is 1392 kbytes/s). The average data transfer standard is approximately 2.85X or 3823 kbytes/s. A DVD-ROM drive reads data on a CD-ROM disc at a variable transfer rate, ranging from 10.3X at the innermost track to 24X at the outermost track. The average data transfer rate is approximately 17.15X or 2936 kbytes/s or 2576 kbytes/s.

†† Maximum speed for faxing is 14.4 kbps. Your modem is capable of downloading at 56 kbps using K56flex technology or V.90. Your online service or Internet Service Provider, however, may not support this technology or operate at this speed.

‡‡ Certain restrictions apply.

*** Height measured at thickest point. Thinnest height is 35.8mm.

If a region code warning appears when you are using the DVD player, it could be that the DVD-ROM you are trying to play is incompatible with the DVD-ROM drive in your VAIO Notebook. Region code indicators such as a "1" or "ALL" are labeled on some DVD discs to indicate what type of player can play the discs. Unless a "1" or "ALL" is labeled on your DVD disc or on the packaging, you cannot play the disc on this player.

Specifications are subject to change without notice.

Index

A

- About the Software on Your Computer **71**
- About Your Recovery CDs **75**
- AC adapter **9**
- AC power **9**
- adding
 - hardware **43**
 - memory **79**
 - peripherals **43**
 - printers **49**
- adjusting
 - brightness **13, 20**
 - contrast **20**
- Alt key **17**
- Application Recovery CD **70**
- Applications key **17**
- attaching port replicator **46**

B

- battery packs **10**
 - charging **11, 38**
 - indicator light status **11**
 - indicator lights **5, 11, 19, 37**
 - inserting **10**
 - inserting into battery bay **10**
 - loading **10**
 - power status **11**
 - rechargeable **9**
 - removing **12, 37, 39**
- brightness
 - adjusting **13, 20**
- built-in speakers **5**
 - See also speakers **20**
- buttons

- Eject **25, 26**
 - left **5**
 - right **5**
 - Start (Windows 98) **14**

C

- cables
 - power cord **9**
- cameras
 - digital video recorder **57**
 - Sony Digital Still **56**
- canceling commands **17**
- Caps Lock **5**
 - indicator light **19**
- CD-ROM/DVD-ROM discs
 - ejecting **26**
 - inserting **25**
 - troubleshooting **62**
- charge status indicator light **11**
- charging battery packs **11, 38**
- choosing
 - power source **10**
- coin-operated telephones **44**
- computer
 - lithium ion battery **v**
 - starting **13**
 - troubleshooting **59, 61**
 - unpacking **2**
- connecting
 - coin-operated telephones **44**
 - digital still camera **56**
 - digital video recorder **57**
 - external keyboard **45**
 - external speakers **54**
 - hard drives **29**

- microphone **55**
- monitor **45, 50**
- mouse **45**
- multimedia computer display **51**
- multiple phone lines **44**
- network **29, 45**
- party phone lines **44**
- PBX **44**
- phone line **44**
- port replicator **45, 46**
- power source **9**
- printer **49**
- projector **51**
- serial device **56**
- USB device **58**
- weight saver **40**
- connectors
 - DC In **9, 45**
 - headphone **6**
 - i.LINK **6**
 - infrared **33**
 - keyboard **5, 7, 45**
 - Line In **6**
 - microphone **6**
 - monitor **45**
 - mouse **7, 45**
 - network **45**
 - Printer **7, 49**
 - printer **49**
 - Serial port **45**
 - USB **7, 45**
- contrast
 - adjusting **20**
- correction keys **16, 17**
- Ctrl key **17**
- cursor-movement keys **17**
- D**
 - DC In **9, 45**
 - digital still camera **33**
 - connecting **56**
 - digital video camera **57**
 - disconnecting port replicator **48**
 - diskettes
 - ejecting **23**
 - inserting into drive **23**
 - troubleshooting **62**
 - display
 - options **52**
 - See also monitor
 - selecting **52**
 - disposal of lithium ion battery **v**
 - drives
 - installing additional hard disk **29**
 - DV devices
 - troubleshooting **64**
 - DV In/Out **57**
 - DVD-ROM drive
 - closing tray **26**
 - opening tray **25**
 - using **25**
 - DVD-ROM drive tray
 - troubleshooting **61**
 - DVD-ROM/CD-ROM discs
 - troubleshooting **62**
- E**
 - Eject button **23, 25, 26**
 - ejecting
 - battery packs **39**
 - CD-ROM/DVD-ROM discs **26**
 - diskettes **23**
 - weight saver **41**
 - Energy Star **ii**
 - Escape key **16**
 - expansion memory configuration **80**
 - Express Service technical support **15**
 - external devices
 - display **52**
 - See also monitor
 - speakers **20, 54**
- F**
 - fan **65**
 - faxes
 - laws governing **v**
 - floppy disk drive
 - disconnecting **24**
 - troubleshooting **62**
 - Fn **21**
 - Fn key **17**
 - combination commands **20**

function keys **16, 17**

H

hard drives

indicator light **5, 19**

installing additional **29**

headphone connector **6, 51**

Help

Mouseware **22**

I

i.LINK **6, 57**

IEEE-1394 **57**

indicator lights **19**

battery **5, 11, 19, 37**

Caps Lock **5, 19**

charge status **11**

hard drive **5, 19**

Num Lock **5, 19**

power **5**

Scroll Lock **5, 19**

infrared communication devices **33**

other computers **33**

infrared port **33**

infrared transmission

active distance **34**

troubleshooting **34**

input devices **iv**

Insert key **17**

inserting

battery pack **10**

CD-ROM/DVD-ROM discs **25**

diskettes into drive **23**

installing

hard drives **29**

hardware **43**

memory module **81**

peripherals **43**

interference **iv**

internal microphone **7**

internal speakers

See speakers

K

keyboard **17, 45**

connector **5, 7**

L

LCD **5**

lock lever **13**

selecting to display output **52**

troubleshooting **61**

LCD (Video) Standby mode **61**

LED indicator **23**

left button **5**

lever

LCD **13**

weight saver release **39**

Limited Warranty card **15**

Line In **6**

Liquid Crystal Display screen

See LCD

lithium ion battery

disposal **v**

safety precautions **v**

loading

battery pack **10**

M

memory module

expansion **80**

installing **81**

removing **80**

Memory Stick **56**

microphone **6**

connecting **55**

connector **51**

internal **7**

troubleshooting **64**

modem

laws governing **v**

troubleshooting **63**

monitor **7, 45**

connecting **50**

connector **51**

selecting **52**

switching among **20**

mouse

connector **7**

troubleshooting **64**

Mouse Properties screen **22**

Mouseware

- accessing help **22**
- features **22**
- multimedia computer display **51**
- multiple phone lines **44**

N

- navigation keys **16, 17**
- network
 - connecting **29**
 - connector **45**
 - port replicator **45**
- Num Lock **5**
 - indicator light **19**
- numeric keypad area **16**

O

- opening
 - DVD-ROM drive tray **25**
- operator keys **17**
- output devices **iv**
 - adding **49**

P

- party phone lines **44**
- PBX **44**
- PC card
 - inserting **29**
 - release button **29**
 - removing **31**
 - slot protector **30**
 - slots **29**
 - troubleshooting **65**
- phone
 - connecting line **44**
 - jack **44**
 - laws governing **v**
- port replicator
 - connecting **45, 46**
 - disconnecting **48**
 - lever **48**
 - network **45**
- power **19**
 - cord **9**
 - indicator light **5**
 - switch **13**
- power saving modes **35**

- System Hibernation **21, 36**
- System Idle **21, 35**
- System Suspend **36**
- Video Standby **21**
- power sources **10**
 - connecting **9**
- Print Screen key **17**
- printer **7**
 - connecting **45, 49**
 - connector **49**
 - port **49**
 - troubleshooting **65**
- Printer connector **7, 45, 49**
- projector **51**

R

- radio interference **iv**
- rechargeable battery packs **9, 10**
- recharging battery packs **11**
- Recovery CD **70**
- registering
 - your computer **15**
- removing
 - battery packs **12**
 - diskettes **23**
 - floppy disk drive **24**
 - memory module **80**
- replacing
 - battery packs **37**
- restoring data **70**
- right button **5**

S

- screen
 - See LCD
- Scroll Lock **5**
 - indicator light **19**
- second battery pack **10, 37**
- selecting
 - display **52**
 - LCD **52**
 - monitor **52**
 - power source **10**
- Serial connector **45, 56**
- serial devices
 - connecting **56**

- digital still camera **56**
- Shift key **17**
- Shut Down Windows dialog box **14**
 - shutting down **14**
 - troubleshooting **65**
- Software Questions **76**
- Sony Service Center **77**
- speakers **5**
 - built-in **5**
 - external **54**
 - switching **20**
 - troubleshooting **63**
 - volume **20**
- Specifications **82**
- Start button **14**
- starting
 - computer **13**
- startup problems **14**
- switching
 - display **20**
 - monitor **20**
- System Hibernation mode **21, 36**
- System Idle mode **21, 35**
- System Recovery CD **68**
- System Suspend mode **20, 36**

T

- touchpad **5, 22, 64**
- troubleshooting **59**
 - startup **14, 59**
- turning on
 - computer **13**
- TV
 - interference **iv**

U

- unpacking the computer **2**
- USB
 - connecting **58**
 - connector **7, 45, 58**
 - mouse **58**

V

- ventilation slot **8**
- video camera **57**
- Video Standby mode **21**

- viewing the amount of memory **81**
- volume control **20**
 - of fan **65**
 - troubleshooting **63**

W

- warranty **15**
- weight saver
 - attaching **37**
 - connecting **40**
 - fold-out arm **40**
 - removing **41**
- Windows **98**
 - Control Panel **34**
 - Explorer **18**
 - Find window **18**
 - help **18**
 - key **17**
 - key combinations **18**
 - Start button **14**
 - taskbar **14, 61**

