

**SONY®**

***VAIO® Notebook  
User Guide***

**PCG-F640**

# Notice to Users

© 2000 Sony Electronics Inc. All rights reserved. This manual and the software described herein, in whole or in part, may not be reproduced, translated, or reduced to any machine-readable form without prior written approval.

SONY ELECTRONICS INC. PROVIDES NO WARRANTY WITH REGARD TO THIS MANUAL, THE SOFTWARE, OR OTHER INFORMATION CONTAINED HEREIN AND HEREBY EXPRESSLY DISCLAIMS ANY IMPLIED WARRANTIES OF MERCHANTABILITY OR FITNESS FOR ANY PARTICULAR PURPOSE WITH REGARD TO THIS MANUAL, THE SOFTWARE, OR SUCH OTHER INFORMATION. IN NO EVENT SHALL SONY ELECTRONICS INC. BE LIABLE FOR ANY INCIDENTAL, CONSEQUENTIAL, OR SPECIAL DAMAGES, WHETHER BASED ON TORT, CONTRACT, OR OTHERWISE, ARISING OUT OF OR IN CONNECTION WITH THIS MANUAL, THE SOFTWARE, OR OTHER INFORMATION CONTAINED HEREIN OR THE USE THEREOF.

Sony Electronics Inc. reserves the right to make any modification to this manual or the information contained herein at any time without notice. The software described herein is governed by the terms of a separate user license agreement.

This product contains software owned by Sony and licensed by third parties. Use of such software is subject to the terms and conditions of license agreements enclosed with this product. Some of the software may not be transported or used outside the United States. Software specifications are subject to change without notice and may not necessarily be identical to current retail versions.

Updates and additions to software may require an additional charge. Subscriptions to online service providers may require a fee and credit card information. Financial services may require prior arrangements with participating financial institutions.



As an ENERGY STAR Partner, Sony Corporation has determined that this product meets the ENERGY STAR guidelines for energy efficiency.

The International ENERGY STAR Office Equipment Program is an international program that promotes energy saving through the use of computers and other office equipment. The program backs the development and dissemination of products with functions that effectively reduce energy consumption. It is an open system in which business proprietors can participate voluntarily. The targeted products are office equipment such as computers, displays, printers, facsimiles and copiers. Their standards and logos are uniform among participating nations. ENERGY STAR is a U.S. registered mark.

Sony, Handycam, i.LINK, Mavica, Media Bar, MovieShaker, PictureGear, VAIO and the VAIO logo are trademarks of Sony Corporation. Microsoft, Windows Me, Windows Media, Windows, Windows NT, and the Windows logo are registered trademarks of Microsoft Corporation. Intel, SpeedStep, and Pentium are trademarks of Intel Corporation. PS/2 is a registered trademark of IBM.

This product incorporates copyright protection technology that is protected by method claims of certain U.S. patents and other intellectual property rights owned by Macrovision Corporation and other rights owners. Use of this copyright protection technology must be authorized by Macrovision Corporation, and is

intended for home and other limited viewing uses only unless otherwise authorized by Macrovision Corporation. Reverse engineering or disassembly is prohibited.

All other trademarks are trademarks of their respective owners.

## Owner's Record

The model number and serial number are located on the bottom of your Sony VAIO® Notebook. Refer to the model and serial number when you call your Sony Service Center.

Model Number: PCG-934A

Serial Number: \_\_\_\_\_

## Safety Information

### WARNING

- ❑ To prevent fire or shock hazard, do not expose your notebook computer to rain or moisture.
- ❑ To avoid electrical shock, do not open the cabinet. Refer servicing to qualified personnel only.
- ❑ Never install modem or telephone wiring during a lightning storm.
- ❑ Never install telephone jacks in wet locations unless the jack is specifically designed for wet locations.
- ❑ Never touch uninsulated telephone wire or terminals unless the telephone line has been disconnected at the network interface.
- ❑ Use caution when installing or modifying telephone lines.

- ❑ Avoid using the modem during an electrical storm.
- ❑ Do not use the modem or a telephone to report a gas leak in the vicinity of the leak.
- ❑ A socket outlet should be as close as possible to the unit and easily accessible.

**!** To change the backup battery, please contact your nearest Sony Service Center.

**!** Caution - The use of optical instruments with this product will increase eye hazard. As the laser beam used in this product is harmful to the eyes, do not attempt to disassemble the cabinet. Refer servicing to qualified personnel only.

**!** For DVD-ROM: Danger - Visible and invisible laser radiation when open. Avoid direct exposure to beam.

**!** Caution: To reduce the risk of fire, use only No. 26 AWG or larger telecommunication line cord.

### AVERTISSEMENT

- ❑ Pour prévenir tout risque d'incendie ou d'électrocution, garder cet appareil à l'abri de la pluie et de l'humidité.
- ❑ Pour prévenir tout risque d'électrocution, ne pas ouvrir le châssis de cet appareil et ne confier son entretien qu'à une personne qualifiée.

- ❑ Ne jamais effectuer l'installation de fil modem ou téléphone durant un orage électrique.
- ❑ Ne jamais effectuer l'installation d'une prise téléphonique dans un endroit mouillé à moins que la prise soit conçue à cet effet.
- ❑ Ne jamais toucher un fil téléphonique à découvert ou un terminal à moins que la ligne téléphonique n'ait été débranché de l'interface réseau.
- ❑ Soyez très prudent lorsque vous installez ou modifiez les lignes téléphoniques.
- ❑ Évitez d'utiliser le modem durant un orage électrique.
- ❑ N'utilisez pas le modem ni le téléphone pour prévenir d'une fuite de gaz vous êtes près de la fuite.
- ❑ L'appareil doit être le plus près possible d'une prise murale pour en faciliter l'accès

**! Pour changer la pile de recharge, veuillez contacter votre centre de service Sony le plus près.**

**! Avertissement - L'utilisation d'instruments optiques avec ce produit augmente les risques pour les yeux. Puisque le faisceau laser utilisé dans ce produit est dommageable pour les yeux, ne tentez pas de désassembler le boîtier. Adressez-vous à un agent de service qualifié.**

**! Pour les DVD-ROM : Danger : Radiation laser visible et invisible si ouvert. Évitez l'exposition directe au faisceau.**

**! Attention : Afin de réduire les risques d'incendie, n'utilisez qu'un cordon de communication NO. 26 AWG ou plus gros.**

If you have questions about this product, you can reach the Sony Customer Information Service Center at 1-888-4SONYPC; or write to the Sony Customer Information Service Center at 12451 Gateway Blvd., Ft. Myers, FL 33913 or find Sony Customer Service on the web at: <http://www.sony.com/pcsupport>

---

## Regulatory Information

### Declaration of Conformity

Trade Name:	SONY
Model No.:	PCG-934A
Responsible Party:	Sony Electronics Inc.
Address:	1 Sony Drive Park Ridge, NJ 07656
Telephone:	201-930-6972
This phone number is for FCC-related matters only.	
This device complies with Part 15 of the FCC rules. Operation is subject to the following two conditions:	
(1) This device may not cause harmful interference, and	
(2) this device must accept any interference received, including interference that may cause undesired operation.	

This equipment has been tested and found to comply with the limits for a Class B digital device, pursuant to Part 15 of the Rules. These limits are designed to provide reasonable protection against harmful interference in a residential installation. This equipment generates, uses, and can radiate radio frequency energy and, if not installed and used in accordance with the instructions, may cause harmful interference to radio communications. However, there is no guarantee that interference will not occur in a particular installation. If this equipment does cause harmful interference to radio or television reception, which can be determined by turning the equipment off and on, the user is encouraged to try to correct the

interference by one or more of the following measures:

- Reorient or relocate the receiving antenna.
- Increase the separation between the equipment and the receiver.
- Connect the equipment into an outlet on a circuit different from that to which the receiver is connected.
- Consult the dealer or an experienced radio/TV technician for help.

You are cautioned that any changes or modifications not expressly approved in this manual could void your authority to operate this equipment.

Only peripherals (computer input/output devices, terminals, printers, etc.) that comply with FCC Class B limits may be attached to this computer product. Operation with non-compliant peripherals is likely to result in interference to radio and television reception.

All cables used to connect peripherals must be shielded and grounded. Operation with cables, connected to peripherals, that are not shielded and grounded, may result in interference to radio and television reception.

### FCC Part 68

This equipment complies with Part 68 of the FCC rules. On the bottom of this equipment is a label that contains, among other information, the FCC equivalence number (REN) for this equipment. If requested, this information must be provided to the telephone company.

This modem uses the USOC RJ-11 telephone jack.

The REN is used to determine the quantity of devices which may be connected to the telephone line. Excessive RENs on the telephone line may result in the devices not ringing in response to an incoming call. In most, but not all areas, the sum of the RENs should not exceed five (5.0). To be certain of the number of devices that may be connected to the line, as determined by the total RENs, contact the telephone company to determine the maximum REN for the calling area.

If the terminal equipment causes harm to the telephone network, the telephone company will notify you in advance that temporary discontinuance of service may be required. But if advance notice is not practical, the telephone company will notify the customer as soon as possible. Also, you will be advised of your right to file a complaint with the FCC if you believe it is necessary.

The telephone company may make changes in its facilities, equipment, operations or procedures that could affect the operations of the equipment. If this happens, the telephone company will provide advance notice in order for you to make the necessary modifications in order to maintain uninterrupted service.

If trouble is experienced with this equipment, you can reach the Sony Customer Information Service Center at 1-888-4SONYPC; or write to the Sony Customer Information Service Center at 12451 Gateway Blvd., Ft. Myers, FL 33913 or find Sony Customer Service on the web at: <http://www.sony.com/pcsupport>

Repair of this equipment should be made only by a Sony Service Center or Sony authorized agent. For the Sony Service Center nearest you, call 1-888-4SONYPC (1-888-476-6972).

This equipment cannot be used on public coin service provided by the telephone company. Connection to Party Line Service is subject to state and possible provincial tariffs. (Contact the state or provincial utility service

commission, public service commission, or corporation commission, for information.)

### **Telephone Consumer Protection Act of 1991 (United States)**

The Telephone Consumer Protection Act of 1991 makes it unlawful for any person to use a computer or other electronic device to send any message via a telephone facsimile machine unless such message clearly contains, in a margin at the top or bottom of each transmitted page or on the first page of the transmission, the date and time it is sent and an identification of the business, other entity, or individual sending the message, and the telephone number of the sending machine or such business, other entity, or individual.

In order to program this information into your facsimile machine, see your fax software documentation.

### **Telephone Consumer Guidelines (Canada)**

Please refer to your telephone directory under 'Privacy Issues' and/or 'Terms of Service.' For more detailed information, please contact:

CRTC  
Terrasses de la Chaudière, Tour centrale  
1 promenade du Portage, 5 étage Hull  
PQ K1A 0N2.

This Class B digital apparatus complies with Canadian ICES-003.

Cet appareil numérique de la classe B est conforme à la norme NMB-003 du Canada.

---

## DISPOSAL OF LITHIUM ION BATTERY

You can return your unwanted lithium ion batteries to your nearest Sony Service Center or Factory Service Center.

 In some areas the disposal of lithium ion batteries in household or business trash may be prohibited.

For the Sony Service Center nearest you, call 1-888-476-6972 in the United States or 1-800-961-7669 in Canada.

**!** Do not handle damaged or leaking lithium ion batteries.

**!** Ne pas manipuler les batteries au lithium-ion qui fuient ou sont endommagées.

**!** Danger of explosion if battery is incorrectly replaced. Replace only with the same or equivalent type recommended by the manufacturer. Discard used batteries according to the manufacturer's instructions.

**!** Une batterie non conforme présente un danger d'explosion. La remplacer seulement par une batterie identique ou de type équivalent recommandé par le fabricant. Évacuer les batteries usées selon les directives du fabricant.

**!** The battery pack used in this device may present a fire or chemical burn hazard if mistreated. Do not disassemble, heat above 212°F (100°C) or incinerate.

**Dispose of used battery promptly. Keep away from children.**

**!** La manutention incorrecte du module de batterie de cet appareil présente un risque d'incendie ou de brûlures chimiques. Ne pas démonter, incinérer ou exposer à une température de plus de 100°C. Évacuer promptement la batterie usée. Garder hors de portée des enfants.

## INDUSTRY CANADA NOTICE

NOTICE: The Industry Canada label identifies certified equipment. This certification means that the equipment meets certain telecommunications network protective, operational and safety requirements as prescribed in the appropriate Terminal Equipment Technical Requirements document(s). The Department does not guarantee the equipment will operate to the user's satisfaction.

Before installing this equipment, users should ensure that it is permissible to be connected to the facilities of the local telecommunications company. The equipment must also be installed using an acceptable method of connection.

The customer should be aware that compliance with the above conditions may not prevent degradation of service in some situations.

Repairs to certified equipment should be coordinated by a representative designated by the supplier. Equipment malfunctions or any repairs or alterations made by the user to this



equipment may give the telecommunications company cause to request that the user disconnect the equipment.

Users should ensure for their own protection that the electrical ground connections of the power utility, telephone lines and internal metallic water pipe system, if present, are connected together. This precaution may be particularly important in rural areas.

**Caution:** Users should not attempt to make such connections themselves, but should contact the appropriate electric inspection authority, or electrician, as appropriate.

**NOTICE:** The Ringer Equivalence Number (REN) assigned to each terminal device provides an indication of the maximum number of terminals allowed to be connected to a telephone interface. The termination on an interface may consist of any combination of devices subject only to the requirement that the sum of the Ringer Equivalence Numbers of all the devices does not exceed 5. The Ringer Equivalence Number for this equipment is 0.0.

## **AVIS DE L'INDUSTRIE CANADA**

**AVIS:** L'étiquette d'Industrie Canada identifie le matériel homologué.

Cette étiquette certifie que le matériel est conforme aux normes de protection, d'exploitation et de sécurité des réseaux de télécommunications, comme le prescrivent les documents concernant les exigences techniques relatives au matériel terminal. Le Ministère n'assure toutefois pas que le matériel fonctionnera à la satisfaction de l'utilisateur.

Avant d'installer ce matériel, l'utilisateur doit s'assurer qu'il est permis de le raccorder aux installations de l'entreprise locale de télécommunication. Le matériel doit également être installé en suivant une méthode acceptée de raccordement. L'abonné ne doit pas oublier

qu'il est possible que la conformité aux conditions énoncées ci-dessus n'empêche pas la dégradation du service dans certaines situations.

Les réparations de matériel homologué doivent être coordonnées par un représentant désigné par le fournisseur. L'entreprise de télécommunications peut demander à l'utilisateur de débrancher un appareil à la suite de réparations ou de modifications effectuées par l'utilisateur ou à cause de mauvais fonctionnement.

Pour sa propre protection, l'utilisateur doit s'assurer que tous les fils de mise à la terre de la source d'énergie électrique, des lignes téléphoniques et des canalisations d'eau métalliques, s'il y en a, sont raccordés ensemble. Cette précaution est particulièrement importante dans les régions rurales.

**Avertissement:** L'utilisateur ne doit pas tenter de faire ces raccordements lui-même; il doit avoir recours à un service d'inspection des installations électriques, ou à un électricien, selon le cas.

**AVIS:** L'indice d'équivalence de la sonnerie (IES) assigné à chaque dispositif terminal indique le nombre maximal de terminaux qui peuvent être raccordés à une interface.

La terminaison d'une interface téléphonique peut consister en une combinaison de quelques dispositifs, à la seule condition que la somme d'indices d'équivalence de la sonnerie de tous les dispositifs n'excède pas 5. L'indice d'équivalence de la sonnerie de ce matériel est de 0.0.



# Contents

<b>Welcome .....</b>	<b>13</b>
Features .....	13
Unpacking Your Notebook .....	14
Ergonomic Considerations .....	17
<b>Setting Up Your VAIO® Notebook .....</b>	<b>21</b>
Locating Controls and Connectors .....	21
Connecting a Power Source .....	25
Starting Your Computer .....	31
Shutting Down Your Computer .....	32
<b>Using Your VAIO® Notebook .....</b>	<b>33</b>
Using the Keyboard .....	33
Using the Touchpad .....	38
Using the Floppy Disk Drive .....	40
Using the DVD-ROM Drive .....	43
Using PC Cards .....	48
Using Infrared Communication Devices .....	51
Using a Second Battery Pack .....	52
Using the Weight Saver .....	56
Using Smart Connect .....	58

**Connecting Peripheral Devices .....59**

Connecting an i.LINK® Device ..... 60  
Connecting a Phone Line ..... 62  
Using Ethernet to Connect to a Network ..... 63  
Connecting a Printer ..... 63  
Connecting an External Mouse or Keyboard ..... 65  
Connecting an External Display ..... 66  
AV Devices ..... 69  
Connecting the Port Replicator ..... 70  
Connecting External Speakers ..... 74  
Connecting an External Microphone ..... 75  
Connecting a Universal Serial Bus (USB) Device .. 76

**Power Saving Modes ..... 77**

**Adding Memory ..... 81**

**About the Software on Your Notebook .. 85**

**About Your Software ..... 89**

PictureGear™ ..... 92  
About Your Recovery CDs ..... 94  
For Answers to Your Software Questions ..... 94  
Using the System and Application Recovery CDs .. 97

**Troubleshooting ..... 101**

**Specifications ..... 113**

**Index ..... 117**



# Welcome

Congratulations on your purchase of the Sony VAIO® notebook. Sony has combined leading-edge technology in audio, video, computing, and communications to provide you with state-of-the-art personal computing.

## Features



For a complete description of the specifications of your VAIO® Notebook, see page 113.

- ❑ **Exceptional performance** — Your notebook includes a mobile Intel® Pentium® III processor featuring Intel® SpeedStep™ and a V.90 compatible K56flex modem.\*
- ❑ **Portability** — Rechargeable battery pack provides hours of use without AC power.
- ❑ **Sony audio and video quality** — High-quality MPEG1/MPEG2 video, which supports full-screen display and enables you to take advantage of today's advanced multimedia applications, games, and entertainment software.
- ❑ **Multimedia features** — Enjoy the stereo speakers or use a headphone (not supplied) to listen to audio and video CDs.
- ❑ **Microsoft® Windows® operating system** — Your system includes Microsoft® Windows® Millennium Edition.
- ❑ **Communications** — Access popular online services, send e-mail, browse the Internet, and use fax features.
- ❑ **DVD** — This new optical storage technology provides increased storage capacity and a rich multimedia computing experience. DVD-ROM drives play both DVD-ROM and CD-ROM discs.

---

\* Actual upload and download speeds may vary due to line conditions, ISP support, and government regulations.

## Unpacking Your Notebook

Remove the following hardware items from the box:

**Main unit\***

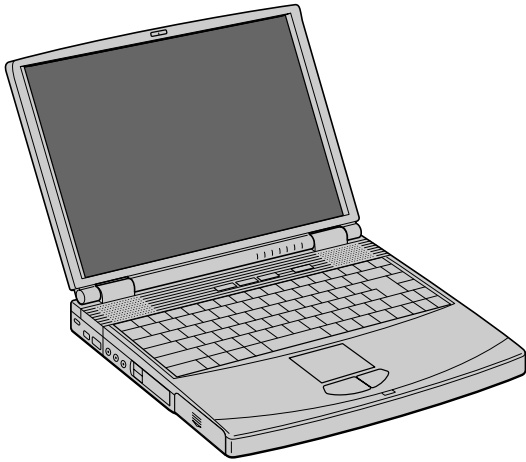

**Power cord**

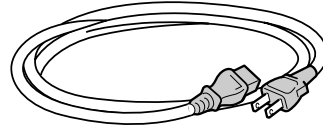

**AC adapter**

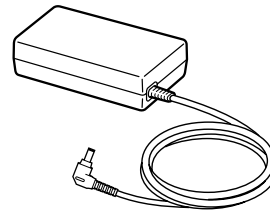

**Video cable**

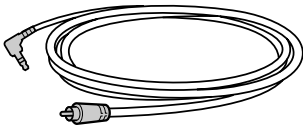

**Rechargeable battery pack**

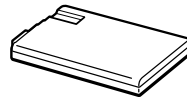

**Weight saver**

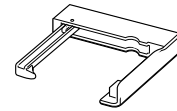

\* Removable floppy disk drive is in the multipurpose bay.

## Manuals

- ❑ **VAIO® User Guide** — Contains information on setting up your notebook, supplementary updates and software information. This manual describes the features and specifications of your notebook, the applications included with your system, how to contact software vendors, and solve common problems.
  
- ❑ **Microsoft® Windows® Millennium Edition Getting Started manual** — Explains how to use the basic features of this latest Windows operating system.

### Software CDs

- ❑ **Microsoft® Word 2000** — Allows you to reinstall Microsoft Word to the VAIO notebook you purchased.

### Recovery CDs

- ❑ **System Recovery CD(s)** — Allows you to restore the software titles that shipped with your computer if they become corrupted or are erased. It can only be used to restore the hard disk of the VAIO notebook you purchased.
- ❑ **Application Recovery CD(s)** — Allows you to reinstall individual applications or device drivers if they become corrupted or erased.

### Other

- ❑ Setting up your VAIO® Notebook (poster)
- ❑ Packet containing special product offers





## Ergonomic Considerations

You will be using your notebook computer as a portable device in a variety of environments. Whenever possible, you should attempt to apply the following ergonomic considerations to both stationary and portable environments.

### Ergonomic Position

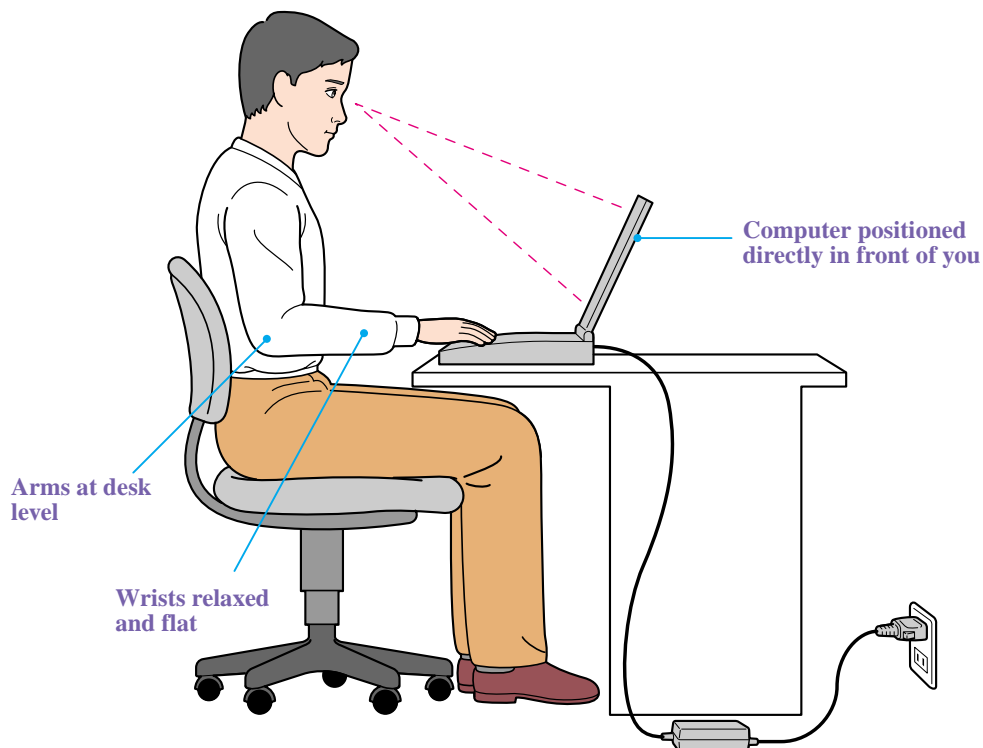

- ❑ **Position of your computer** — Place the computer directly in front of you as you work. Keep your forearms horizontal, with your wrists in a neutral, comfortable position while using the keyboard, touchpad, or external mouse. Let your upper arms hang naturally at your sides. Take breaks during sessions with your computer. Excessive use of the computer may strain muscles or tendons.
- ❑ **Furniture and posture** — Sit in a chair with good back support and armrests. Adjust the level of the chair so your feet are flat on the floor. A footrest may make you more comfortable. Sit in a relaxed, upright posture and avoid slouching forward or leaning far backward.

- ❑ **Viewing angle of the computer's display** — Use the display's tilting feature to find the best position. You can reduce eye strain and muscle fatigue by adjusting the tilt of the display to the proper position. Adjust the brightness setting of the display also.
- ❑ **Lighting** — Choose a location where windows and lights do not create glare and reflection on the display. Use indirect lighting to avoid bright spots on the display. You can also purchase accessories for your display that help reduce glare. Proper lighting adds to your comfort and work effectiveness.
- ❑ **Placement of an external display** — When using an external display, set the display at a comfortable viewing distance. Make sure the display screen is at eye level or slightly lower when you are sitting in front of the monitor.

### Notes on Setup

- ❑ Do not place your computer in a location subject to:
  - ❑ Heat sources, such as radiators or air ducts
  - ❑ Direct sunlight
  - ❑ Excessive dust
  - ❑ Moisture or rain
  - ❑ Mechanical vibration or shock
  - ❑ Strong magnets or speakers that are not magnetically shielded
  - ❑ Ambient temperature of more than 95° F (35° C) or less than 18° F (10° C)
  - ❑ High humidity
- ❑ Do not place electronic equipment near your computer. The computer's electromagnetic field may cause a malfunction.
- ❑ Provide adequate air circulation to prevent internal heat buildup. Do not place your computer on porous surfaces such as rugs or blankets, or near materials such as curtains or draperies that may block its ventilation slots. Leave a space of at least 8 inches (20 cm) behind the back panel of the computer.
- ❑ If the computer is brought directly from a cold location to a warm one, moisture may condense inside your computer. In this case, allow at least an hour before turning on your computer. If any problems occur, unplug your computer, and contact your Sony Service Center.

- ❑ The computer uses high-frequency radio signals and may cause interference to radio or TV reception. Should this occur, relocate the computer a suitable distance away from the set.
- ❑ Use only specified peripheral equipment and interface cables; otherwise, problems may result.
- ❑ Do not use cut or damaged connection cables.
- ❑ If the telephone company makes a service call to your home or office and determines that your computer is responsible for a problem, the telephone company may bill you for the service call. Also, if you do not disconnect your computer when it is adversely affecting the telephone line, the telephone company has the right to disconnect your service until you correct the problem.

### ***Handling Your Notebook***

- ❑ Clean the cabinet with a soft, dry cloth or a soft cloth lightly moistened with a mild detergent solution. Do not use any type of abrasive pad, scouring powder, or solvent such as alcohol or benzine, as these may damage the finish of your computer.
- ❑ Should any solid object or liquid fall into the computer, shut down your computer and then unplug it. You may want to have the computer checked by qualified personnel before operating it any further.
- ❑ Do not drop the computer or place heavy objects on top of the computer.

### ***Cleaning Your Notebook***

- ❑ Make sure to disconnect the power cord before cleaning the computer.
- ❑ Avoid rubbing the LCD screen as this can damage the screen. Use a soft, dry cloth to wipe the LCD screen.
- ❑ Clean the computer with a soft cloth lightly moistened with a mild detergent solution. Do not use any type of abrasive pad, scouring powder or solvent, such as alcohol or benzine.

### ***Handling the LCD Screen***

- ❑ Do not leave the LCD facing the sun as it can damage the LCD. Be careful when using the computer near a window.

- ❑ Do not scratch the LCD or exert pressure on it. This could cause malfunction.
- ❑ Using the computer in low temperature conditions may produce a residual image on the screen. This is not a malfunction. When the computer returns to normal temperature, the screen returns to normal.
- ❑ The screen becomes warm during operation. This is normal and does not indicate a malfunction.
- ❑ The LCD is manufactured using high-precision technology. You may, however, see tiny black points and/or bright points (red, blue, or green) that continuously appear on the LCD. This is a normal result of the manufacturing process and does not indicate a malfunction.

# Setting Up Your VAIO® Notebook

This section describes how to start using your notebook and how to use your computer's internal and external devices, such as the touchpad, floppy disk drive, and DVD-ROM drive.

## Locating Controls and Connectors

### Front

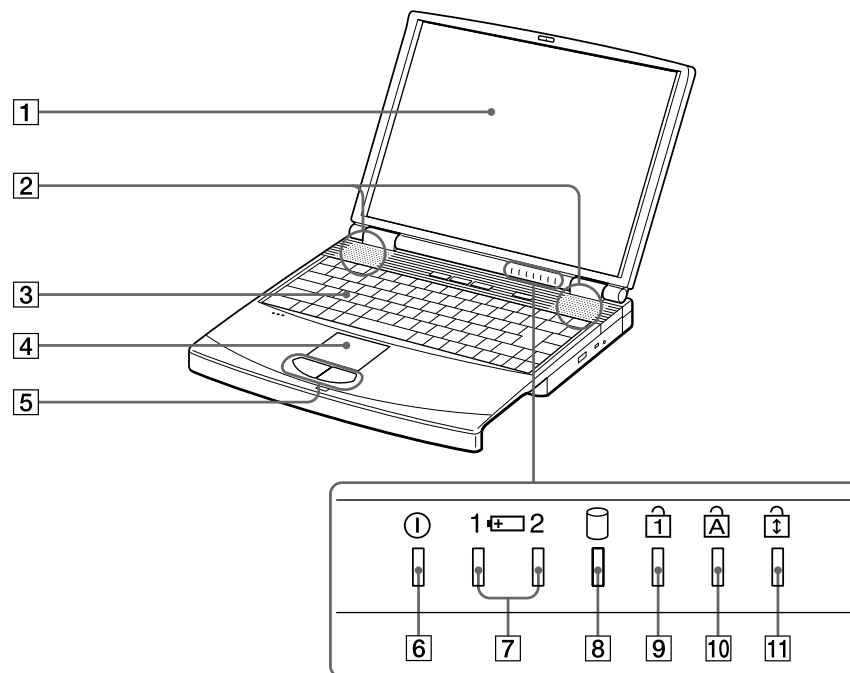

- |           |                                            |
|-----------|--------------------------------------------|
| <b>1</b>  | <b>LCD (Liquid Crystal Display) screen</b> |
| <b>2</b>  | <b>Speakers</b>                            |
| <b>3</b>  | <b>Keyboard</b>                            |
| <b>4</b>  | <b>Touchpad</b>                            |
| <b>5</b>  | <b>Left/right buttons</b>                  |
| <b>6</b>  | <b>Power indicator</b>                     |
| <b>7</b>  | <b>Battery 1 and 2 indicators</b>          |
| <b>8</b>  | <b>Hard disk drive indicator</b>           |
| <b>9</b>  | <b>Num Lock indicator</b>                  |
| <b>10</b> | <b>Caps Lock indicator</b>                 |
| <b>11</b> | <b>Scroll Lock indicator</b>               |

**Left**

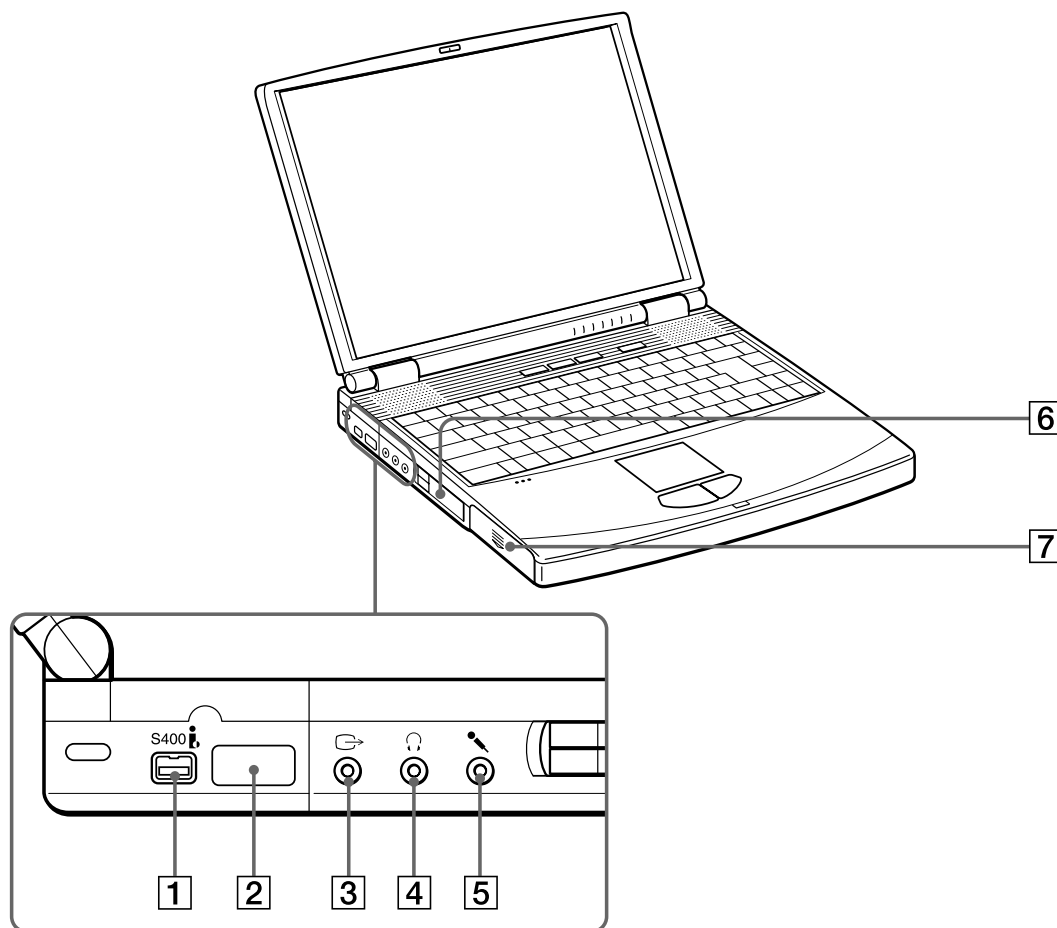

**1**  *i.LINK® (IEEE1394) S400 connector*

**2** *Infrared port*

**3** *Video out*

**4**  *Headphone connector*

**5**  *Microphone connector*

**6** *PC card slots*

**7** *Battery bay*





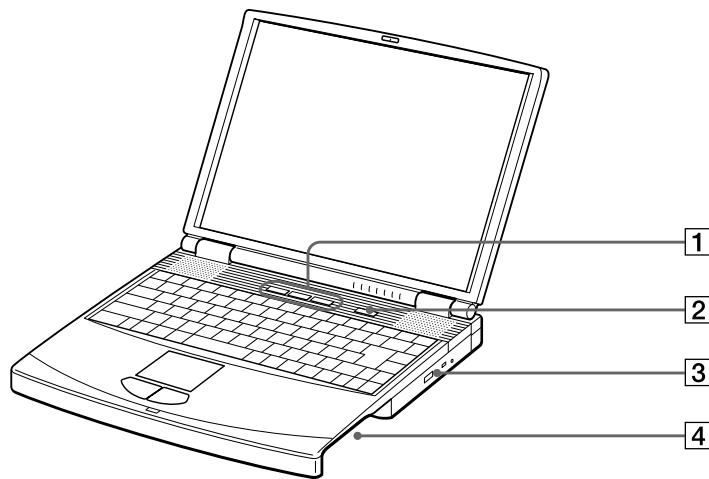

**Right**

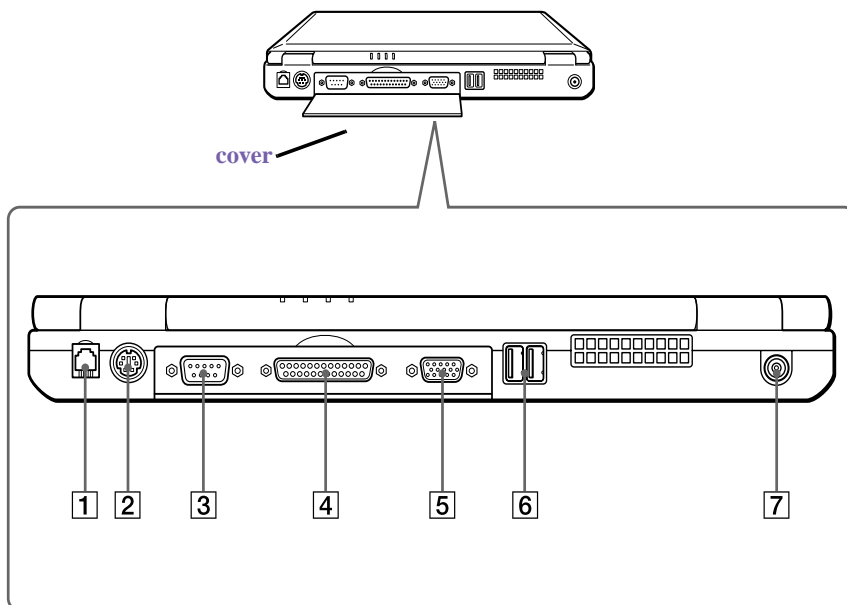

- 1 **PPK buttons**
- 2 **Power button**
- 3 **DVD-ROM drive**
- 4 **Multipurpose bay**

**Back**



- 
- |          |                                                                                                            |
|----------|------------------------------------------------------------------------------------------------------------|
| <b>1</b> | <b>Modem jack</b>                                                                                          |
| <b>2</b> | <b>PS/2 Mouse/Keyboard connector</b>                                                                       |
| <b>3</b> | <b>Serial connector</b>                                                                                    |
| <b>4</b> | <b>Printer connector</b>                                                                                   |
| <b>5</b> |  <b>Monitor connector</b> |
| <b>6</b> |  <b>USB connectors</b>    |
| <b>7</b> |  <b>DC In connector</b>   |
- 

 There is a ventilation slot located between the USB connector and the DC In connector. Do not cover the ventilation slot when your computer is on.

### Bottom

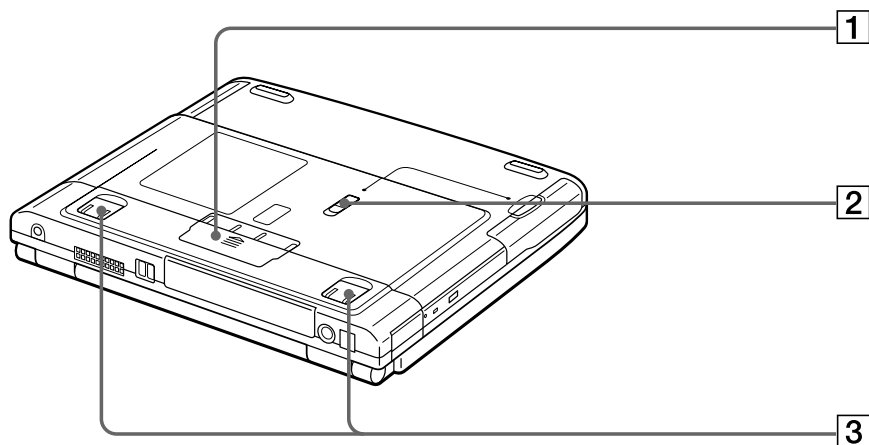

- 
- |          |                                        |
|----------|----------------------------------------|
| <b>1</b> | <b>Port replicator connector cover</b> |
| <b>2</b> | <b>Multipurpose bay RELEASE lever</b>  |
| <b>3</b> | <b>Tilt stands</b>                     |
-

## Connecting a Power Source

You can use either AC power or a rechargeable battery pack as a power source.

### Using the AC Adapter

- 1 Plug the cable attached to the AC adapter into the DC In connector on the computer.
- 2 Plug one end of the power cord into the AC adapter.
- 3 Plug the other end of the power cord into an AC outlet.

### Connecting the AC adapter

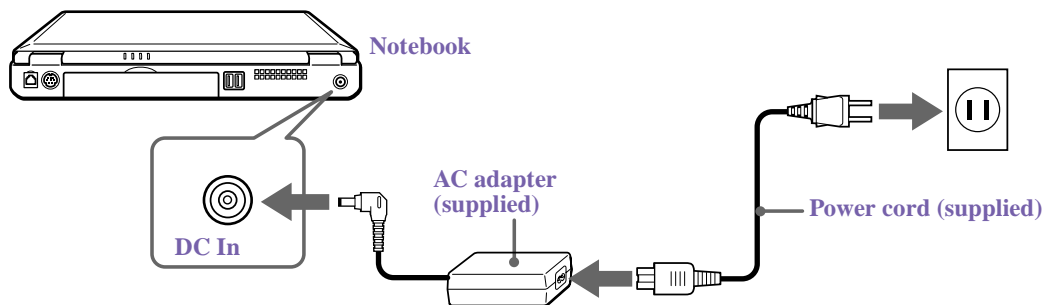

### Notes on the AC Adapter

- ❑ Your computer operates on 100V-240V AC 50/60 Hz.
- ❑ Do not share the AC outlet with other power-consuming equipment, such as a copy machine or shredder.
- ❑ You can purchase a power strip with a surge protector. This device prevents damage to your computer caused by sudden power surges such as those that may occur during an electrical storm.
- ❑ Do not place heavy objects on the power cord.
- ❑ To disconnect the cord, pull it out by the plug. Never pull the cord itself.
- ❑ Unplug your computer from the wall outlet if you will not be using the computer for a long time.
- ❑ When the AC adapter is not used, unplug it from the AC outlet.
- ❑ Use only the AC adapter supplied. Do not use any other AC adapter.

## ***Using Battery Power***

You can use one or two battery packs as a source of power. The second battery pack inserts into the multipurpose bay on the right side of the computer. (See “Power Saving Modes” on page 77.) Additional battery packs are available as a separate option.

The battery pack that comes with your computer is not fully charged at the time of purchase. Follow the steps below to insert and charge the battery pack.

### ***To insert the battery pack***

- 1 To open the battery bay, press cover down.

 Cover swings out but does not detach.

### ***Battery bay***

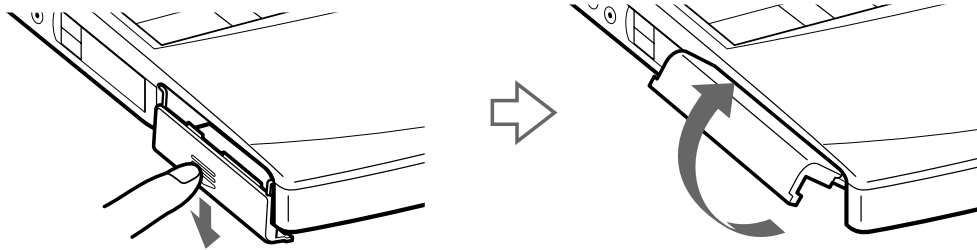

- 2 Insert the battery pack into the battery bay on the left side of the computer.

### Inserting battery pack

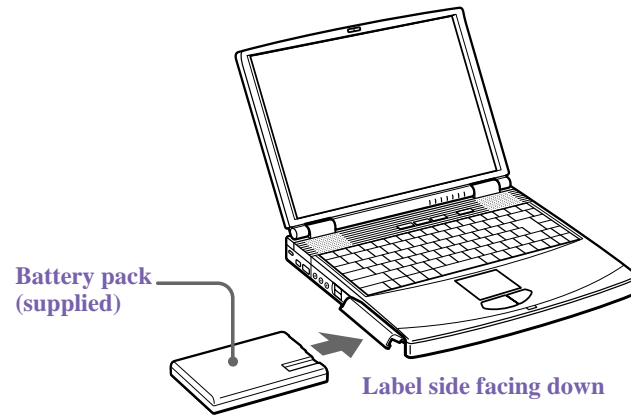

- 3 Close the cover of the battery bay until it clicks.

 If the port replicator is attached to your computer, do not attempt to insert or remove the battery pack. Lifting and turning the computer with a port replicator attached could cause a temporary loss of power.

### To charge the battery pack

- 1 Connect the AC adapter to the computer.
- 2 Insert the battery pack.

The computer automatically charges the battery (the battery indicator light flashes in a double blink pattern as the battery charges).

- 3 When the battery is 85% full, the battery indicator light turns off. This process takes approximately two hours.

 To charge the battery completely, continue charging for an additional hour. See “Displaying Battery Information” in the online manual “*Customizing Your VAIO® Notebook*”.

*There are two battery indicator lights on the computer*

**Battery indicator lights**

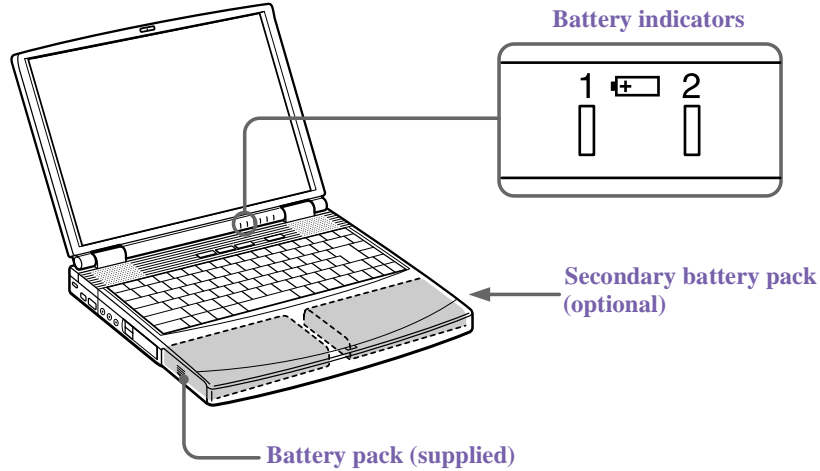

<b>Battery Indicator</b>	<b>Meaning</b>
1	<i>Indicates the status of the battery pack in the battery bay on the left side of the computer.</i>
2	<i>Indicates the status of the battery pack in the multipurpose bay on the right side of the computer.</i>

<b>Battery Indicator Light Status</b>	<b>Meaning</b>
<i>On</i>	<i>The computer is using battery power.</i>
<i>Single blink</i>	<i>The battery is running out of power.</i>
<i>Double blink</i>	<i>The battery is charging.</i>
<i>Off</i>	<i>The computer is using AC power.</i>

### **To remove the battery pack**

- 1 Open the battery bay cover.
- 2 Pull out the battery pack.

### **Removing the battery pack**

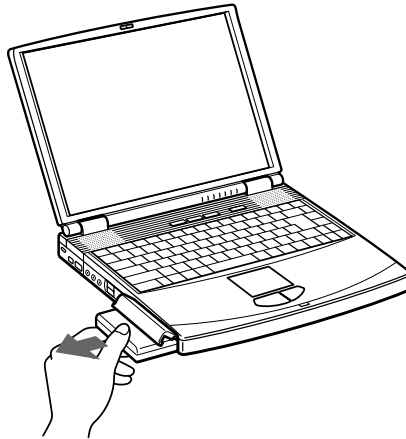

- 3 Close the cover of the battery bay.



**You will lose data if you remove the battery pack while the computer is on and not connected to the AC adapter or if you remove the battery while the computer is in a power-saving mode**

### **Notes on the battery**

- ❑ To determine the remaining battery charge, see “Displaying Battery Information” in the online manual *“Customizing Your VAIO® Notebook”*
- ❑ When the battery power is running low, both the battery and power indicators blink.
- ❑ When the computer is directly connected to AC power and has a battery pack in the battery bay, it uses power from the AC outlet.
- ❑ See “Power Saving Modes” on page 77 for information on installing and charging a battery pack in the multipurpose bay.
- ❑ Keep the battery pack in the computer while it is directly connected to AC power. The battery pack continues to charge while you are using the computer.



- ❑ If the battery level falls below 10%, you should either attach the AC adapter to recharge the battery or shut down your computer and insert a fully charged battery.
- ❑ You can extend battery life by changing the power-management modes in the PowerPanel utility. See “Power Saving Modes” on page 77.
- ❑ The battery pack supplied with your computer is a lithium-ion battery and can be recharged at any time. Charging a partially discharged battery does not affect battery life.
- ❑ The battery indicator light is on while you use the battery pack as a power source. When battery life is nearly depleted, the battery indicator starts flashing.
- ❑ For some software applications and some peripheral devices, your computer may not enter System Hibernation mode when the battery life is low. To avoid loss of data when using battery power, you should save your data frequently and manually activate a power-management mode, such as System Suspend or System Hibernation.
- ❑ Never leave the battery pack in temperatures above 140° F (60° C), such as under direct sunlight or in a car parked in the sun.
- ❑ Battery life is shorter in a cold environment. This is due to decreased battery efficiency at low temperatures.
- ❑ Charge the batteries at temperatures between 50° F and 80° F (10° C to 30° C). Lower temperatures require a longer charging time.
- ❑ While the battery is in use or being discharged, the battery pack heats up. This is normal and is not cause for concern.
- ❑ Keep the battery pack away from all sources of heat.
- ❑ Keep the battery pack dry.
- ❑ Do not open or try to disassemble the battery pack.
- ❑ Do not expose the battery pack to any mechanical shock.
- ❑ If you are not using the computer for an extended period of time, remove the battery pack from the computer to prevent damage to the battery.
- ❑ If, after fully charging the battery pack, the battery power is still low, the battery pack may be reaching the end of its life and should be replaced.
- ❑ You do not need to discharge the battery before recharging.
- ❑ If you have not used the battery pack for a considerable amount of time, recharge the battery.

## Starting Your Computer

- 1 Slide the LCD lock lever in the direction of the arrow, and lift the cover.

### Opening the computer

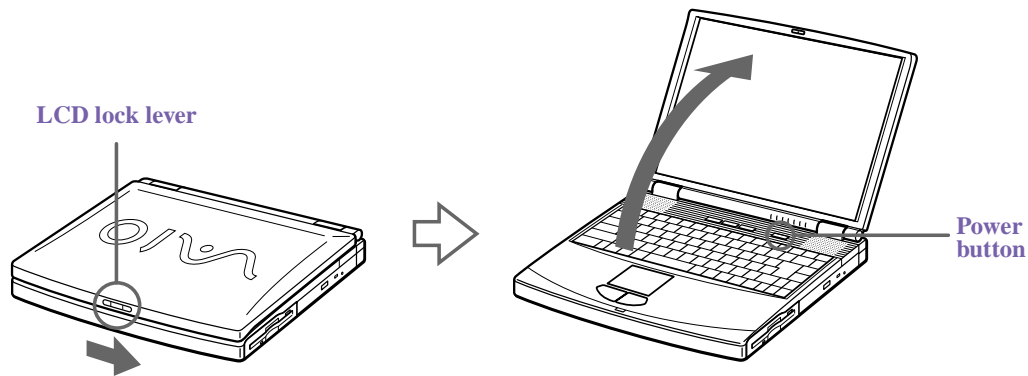

- 2 Press the power button on top of the computer until the green power indicator light turns on.

 When starting your notebook for the first time, the VAIO InitManager dialog box will appear. Please select “OK” to begin initial setup. If you do not execute the initial setup, you cannot use VAIO original hardware functions such as PPK, Power Management tools, the scroll function of the touchpad, and keyboard shortcut key combined with Fn key.

### Power button

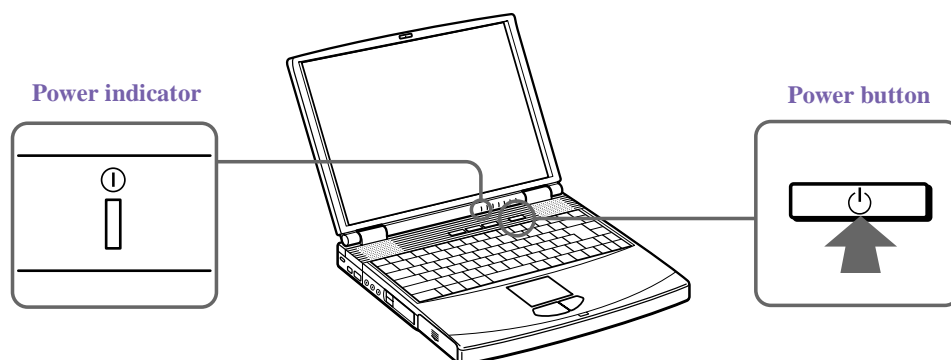

 If you hold the power button in the On position for more than four seconds, the computer turns off.

- 3 If necessary, adjust the brightness controls for the LCD display:
  - Decrease brightness, press Fn+F5 and then the down or left arrow key.
  - Increase brightness, press Fn+F5 and then the up or right arrow key.

## Shutting Down Your Computer

**To avoid potential loss of data, follow these steps to shut down your computer.**

- 1 Click the Start button on the Windows® taskbar.
- 2 Click Shut Down at the bottom of the Start menu to display the Shut Down Windows dialog box.
- 3 Select Shut down.
- 4 Click OK.

 Respond to any prompts warning you to save documents.

- 5 Wait for your computer to turn off automatically—power indicator turns off.
- 6 Turn off any peripherals connected to your computer.

 During a period of inactivity, you can conserve battery life by using System Suspend mode. See “Controlling Power Management” in the online manual “*Customizing Your VAIO® Notebook*”.

### *If you are unable to shut down your computer:*

- 1 Close or end all operations:
  - close all applications
  - remove the PC cards
  - disconnect USB devices
  - end Infrared Communication
- 2 Then, restart the computer. You can restart your computer by pressing Ctrl+Alt+Delete keys (at the same time).

 If you are still unable to shut down the computer, you can press the power button and hold it for four seconds. This operation may result in data loss.

# Using Your VAIO® Notebook



## Using the Keyboard

Your keyboard is very similar to a typewriter's, but the keyboard has additional keys that perform specific computer-related tasks.

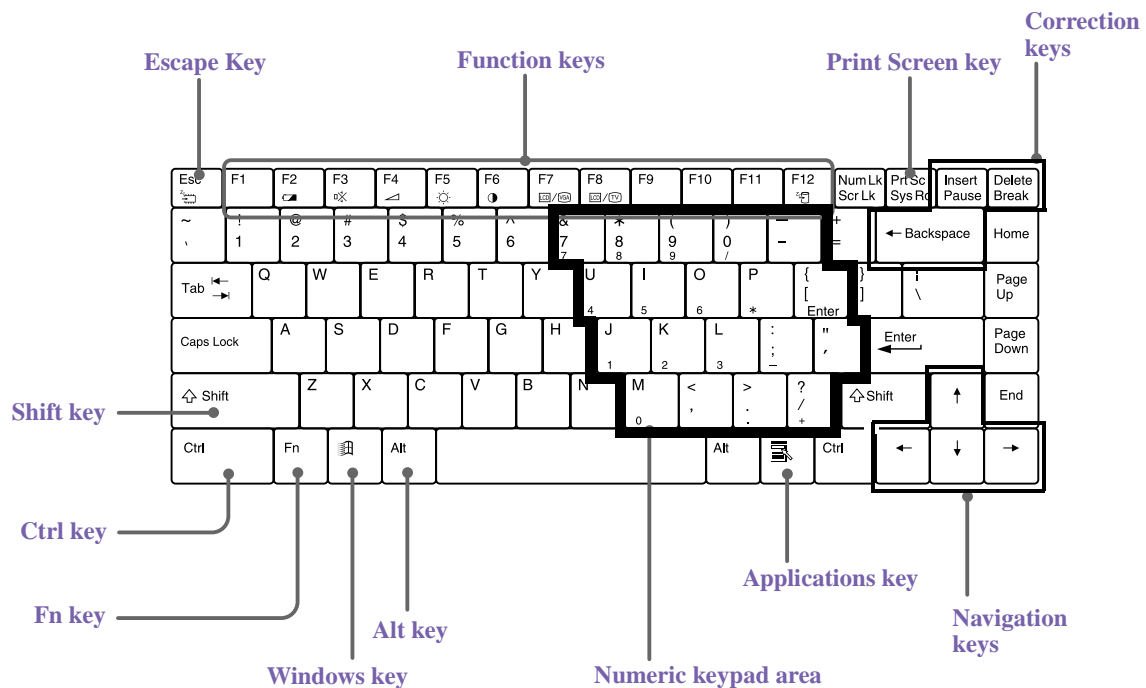



### Keyboard







Key	Description
Numeric keypad area	Contains the keys found on a typical calculator. Use the numeric keypad area to type numbers or to perform mathematical calculations such as addition and subtraction. Note that you must press the Num Lock key to activate the numeric keypad. (When you do so, the Num Lock light will be on.)
Navigation keys	Several keys are devoted to moving the cursor on the screen.
Correction keys	The Insert, Back Space, and Delete keys enable you to make corrections in your documents.





<i>Key</i>	<i>Description</i>
Function keys	The twelve function keys along the top of the keyboard are used to perform designated tasks. For example, in many applications, F1 is the Help key. The task associated with each function key may vary from one application to the next.
Escape key	The Esc (Escape) key is used to cancel commands.
Print Screen key	The Print Screen key takes an electronic snapshot of the screen and places it in the Windows Clipboard. You can then paste the screen shot into a document and print it.
Operator keys	Several keys are always used with at least one other key: Ctrl, Alt, and Shift. When held down with another key, the Ctrl (Control) and Alt (Alternate) keys offer another way to give commands. For example, in many applications, instead of choosing the Save command from a menu, you can hold down Ctrl and press S (referred to as Ctrl+S). The Shift key operates the same way as on a typewriter; it is used to produce capital letters or special symbols such as @ and \$.
Windows key 	The key with the Windows logo displays the Windows Start menu; it is the equivalent of clicking the Start button on the taskbar. See “Combinations and Functions with the Windows Key” on page 34.
Fn key	The Fn key is used in combination with other keys to issue commands. See “Combinations and Functions with the Fn Key” on page 36.
Applications key 	The Applications key displays a shortcut menu of context-sensitive choices. Pressing this key is the equivalent of clicking the right mouse button.

## **Combinations and Functions with the Windows Key**

<i>Combination</i>	<i>Function</i>
 + F1	Displays Windows Help.
 + Tab	Switches the selected button on the taskbar.
 + E	Displays Windows Explorer.
 + F	Displays the Windows Find: All Files window to find a file or folder. This is the equivalent of selecting Find and then Files or Folders from the Start menu.

<i>Combination</i>	<i>Function</i>
 + Ctrl + F	Displays the Windows Find: Computer window where you can locate other computers. This is the equivalent of selecting Find and then Computer from the Start menu.
 + M	Minimizes all displayed windows.
Shift +  + M	Returns all minimized windows to their previous size.
 + R	Displays the Run window. This is the equivalent of selecting Run from the Start menu.
Fn +  + Insert	Displays the Properties window. This is the equivalent of double-clicking the System icon in the Control Panel.









## Indicators

<i>Indicator</i>	<i>Function</i>
Power 	Light is green when the power to the computer is turned on. Light is red in System Idle mode, and flashes red in System Suspend mode. The light turns off when the computer is in System Hibernation mode or powered off.
Battery 1 	Indicates the status of the battery inserted in the battery bay on the left side of the computer.
Battery 2 	Indicates the status of the battery inserted in the multipurpose drive bay on the right side of the computer.
Hard disk 	Lights when data is being read from or written to the hard drive. Do not enter System Suspend mode or turn off the computer when this indicator light is on.



**Indicator (continued)**

<b>Light</b>	<b>On</b>	<b>Off</b>
Num Lock	The number keys in the numeric keypad are active.	The alphanumeric character keys in the keypad area are active.
Caps Lock	The letters appear in uppercase as you type. The Shift key lowers the case of typed letters when Caps Lock is on.	Letters appear in lower case as you type (unless you hold down the Shift key).
Scroll Lock	The screen scrolls differently. (Exactly how it scrolls depends on the specific application. It has no effect in many applications.)	Information moves across the display normally.

**Combinations and Functions with the Fn Key**

<b>Combinations/ Feature</b>	<b>Function</b>
Fn+  (ESC) System Suspend	Puts the system into System Suspend mode, a power-management state. To return the system to the active state, press any key or press the power button on your computer.
Fn+  (F2) Display power source status	Displays the power source status, as in the example below: <div style="display: flex; justify-content: space-around; align-items: center;"> <div style="text-align: center;">  Using AC power         </div> <div style="text-align: center;">  Charging a battery pack         </div> </div>
Fn+  (F3) Mute On/Off	Toggles the built-in speaker off and on.
Fn+  (F4) Speaker volume	Adjusts the built-in speaker volume. To increase volume, press Fn+F4, then <b>↑</b> or <b>→</b> . To decrease volume, press Fn+F4, then <b>↓</b> or <b>←</b> .
Fn+  (F5) Brightness control	Adjusts the brightness of the LCD. To increase light intensity, press Fn+F5 and then <b>↑</b> or <b>→</b> . To decrease light intensity, press Fn+F5 and then <b>↓</b> or <b>←</b> .
Fn+  (F6) Contrast control	Adjust the screen contrast.

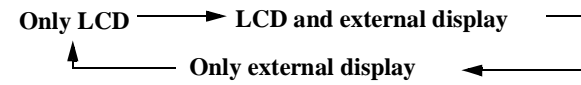
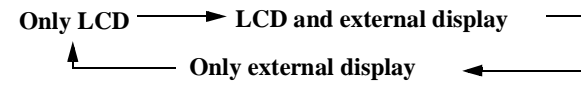
## Combinations and Functions with the Fn Key (Continued)

Combinations/ Feature	Function
Fn+ <b>LCD</b> / <b>VGA</b> (F7) Switch to the external monitor/LCD	Toggles through the LCD, external display (connected to the  Monitor connector) and both LCD and external display. 
Fn+ <b>LCD</b> only/ <b>TV</b> (F8) Control TV out	Toggles between LCD-only and dual LCD/TV display modes. 
Fn+  (F12) System Hibernation	Provides for the lowest level of power consumption. When you execute this command, the state of the system and state of the peripheral devices are written to the hard disk and the system power is turned off. To return the system to its original state, use the power button to turn on power.
Fn+D Video standby	Turns off the LCD to save power. To turn the LCD back on, press any key.
Fn+S System Idle	Puts the system into System Idle mode, a power-management state. To return the system to the active state, press any key.

 Some functions are not available until Windows launches.



## Using the Touchpad

The keyboard contains a cursor-pointing device called a touchpad. You can point to, select, drag, and scroll objects on the screen using the built-in touchpad.

### Touchpad

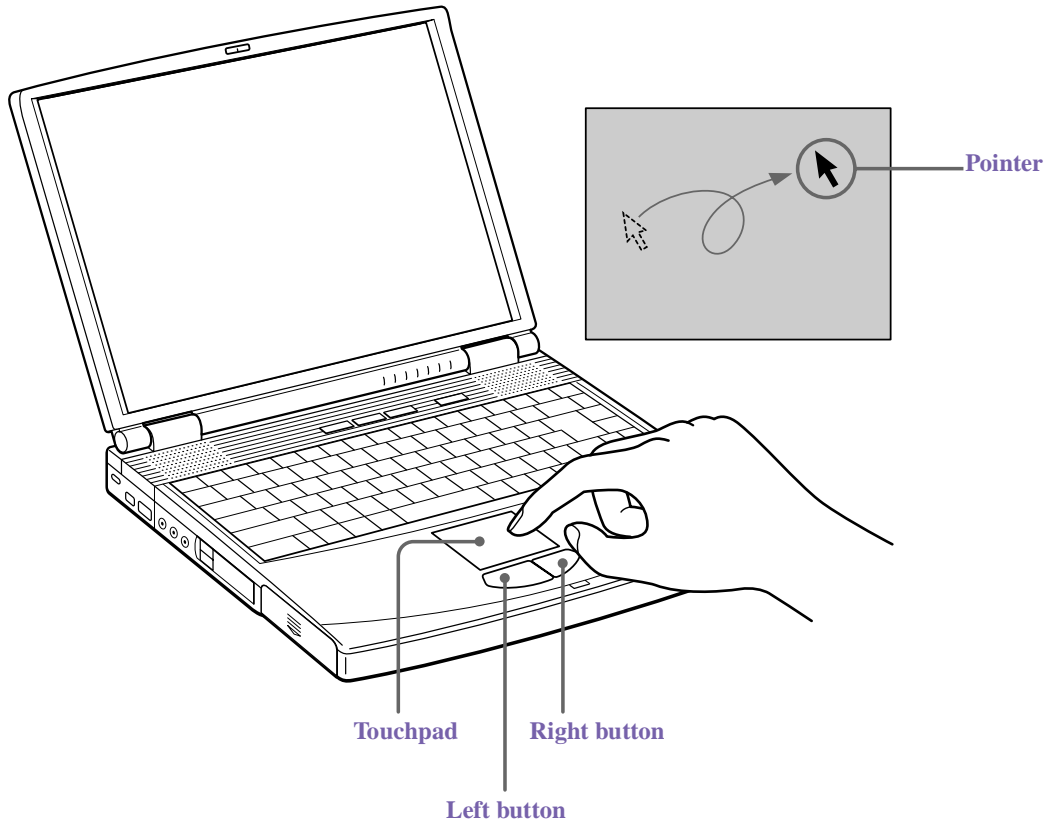

<i><b>Action</b></i>	<i><b>Description</b></i>
Point	Slide one finger on the touchpad to place the pointer on an item or object.
Click	Press the left button once.
Double-click	Press the left button twice.

<i>Action</i>	<i>Description</i>
Right-click	Press the right button once. In many applications, this action displays a shortcut menu of context-sensitive choices.
Drag	Slide one finger while pressing the left button.
Scroll	Move your finger along the right edge of the touchpad to scroll vertically. Move your finger along the bottom to scroll horizontally. (The scroll function is available only with applications that support a touchpad scroll feature.)

 See Mouse Properties for information on touchpad features, such as clicking both buttons simultaneously, adjusting touchpad speed, and Easy Launcher functions. To access Mouse Properties, click the Start button, point to Settings, point to Control Panel, and then click the Mouse icon in the Control Panel.

## Using the Floppy Disk Drive

Your computer comes with the floppy disk drive in the multipurpose bay.

### To insert a diskette

- 1 Hold the diskette the label side facing up.
- 2 Gently push the diskette into the drive until it clicks into place.

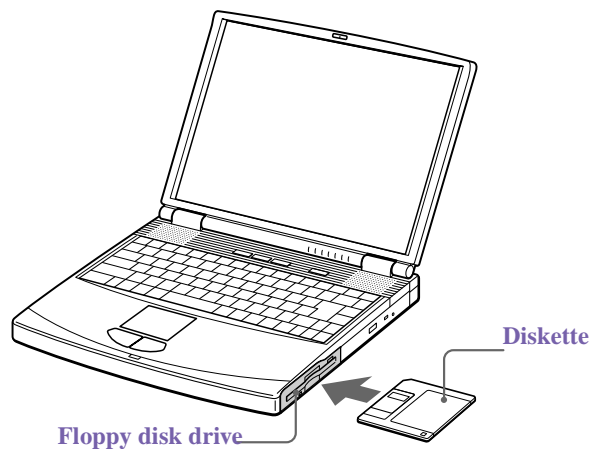

### To remove a diskette

- When you finish using the diskette, wait until the LED indicator light turns off and then press the Eject button to remove the diskette.

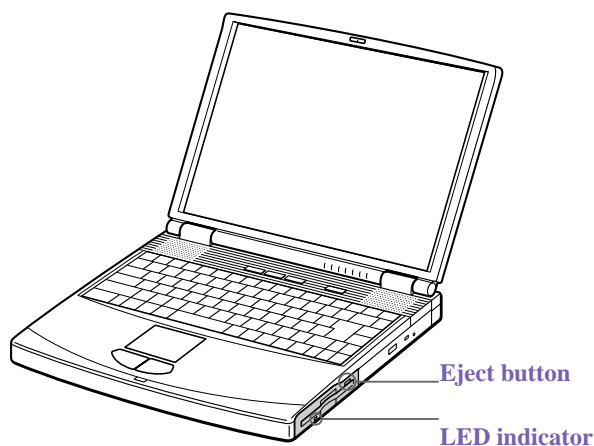

 Do not push the eject button when the LED indicator is turned on. Otherwise, data maybe lost.

***To remove the floppy disk drive***

- 1 Turn off the computer.
- 2 There is a RELEASE lever on the bottom of the computer. Slide this lever in the direction of the arrow.

***Multipurpose bay release lever***

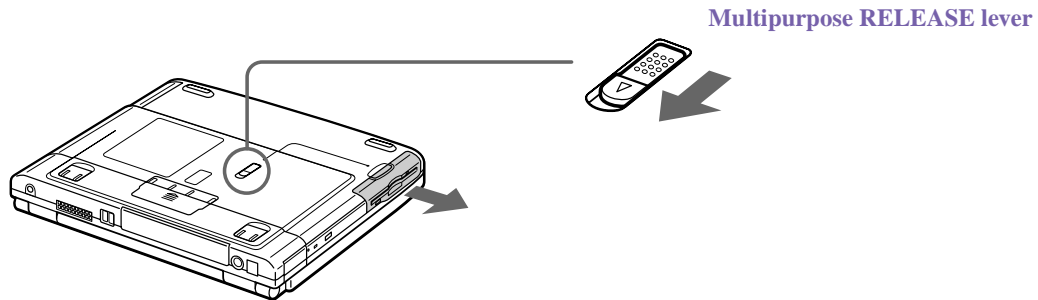

- 3 Slide the drive out of the multipurpose bay.
- 4 Insert the weight saver. See “Using the Weight Saver” on page 56.

***To reinsert the floppy disk drive***

- 1 Turn off the computer.
- 2 If another device is in the multipurpose bay, remove the device. See “To remove the second battery pack” on page 54.

- 3 Insert the floppy disk drive into the multipurpose bay with the VAIO label facing up. Continue pushing the drive into the bay until the RELEASE lever locks into place.

*Inserting the floppy disk drive*

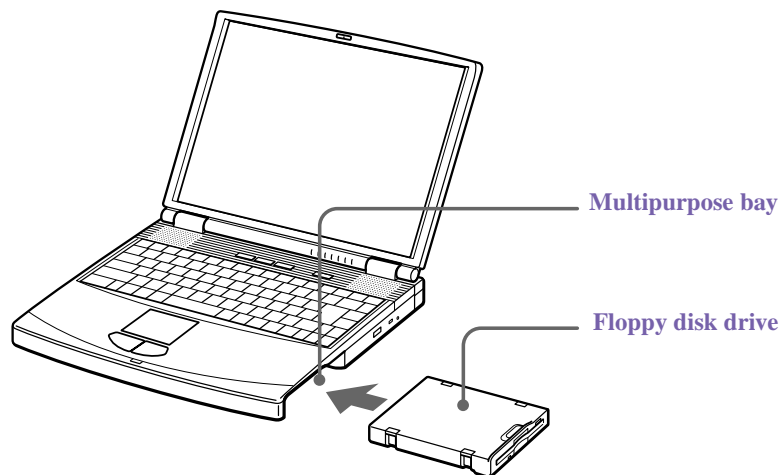

## Using the DVD-ROM Drive

Your computer comes with a DVD-ROM drive, which plays both DVD and CD.

### To insert a disc

- 1 Turn on the computer.

 When the computer is in System Suspend or System Hibernation mode, you cannot insert a disc. See “Controlling Power Management” in the online manual “Customizing Your VAIO® Notebook” for more information on System Suspend and System Hibernation modes.

- 2 Press the Eject button to open the DVD-ROM drive.

The tray slides out.

### DVD eject

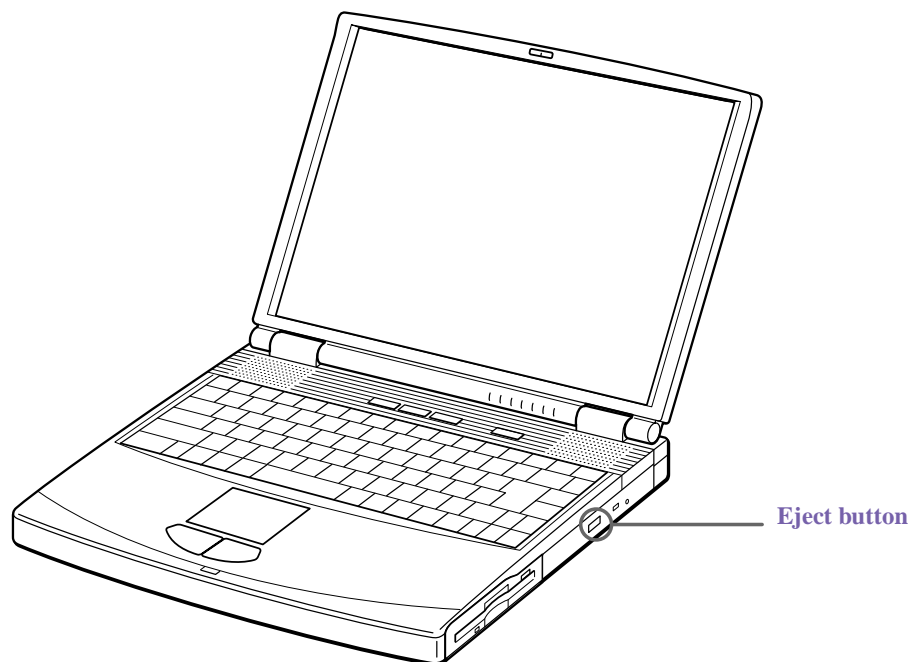

- 3 Place a CD or DVD on the tray with the label side facing up. For DVDs which can be played on both sides, the side of the disc facing up is the side that plays.

- 4 Push the disc onto the hub until the disc clicks securely into place.

*Inserting a DVD/CD*

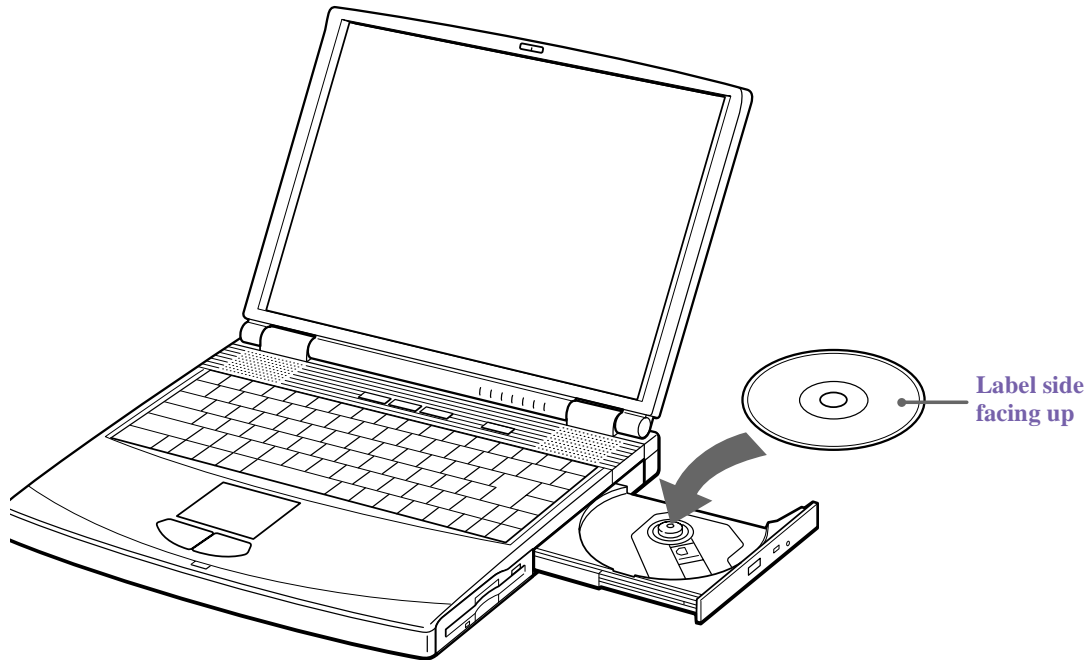

5 Close the tray by pushing it gently.

 Be sure to seat the disc firmly over the hub fingers. If you do not seat the disc firmly, you could damage your DVD-ROM drive and you may not be able to open the tray.

When you finish using a disc, wait until the LED indicator light turns off, then press the Eject button to remove the disc.

When the computer is in Power Saving modes, you cannot remove a disc. See “Controlling Power Management” in the online manual “*Customizing Your VAIO® Notebook*” for more information about Power Saving modes.

If the disc does not come out when you press the Eject button, turn off the computer and insert a thin, pointed object into the manual eject hole.

**Manual eject hole**

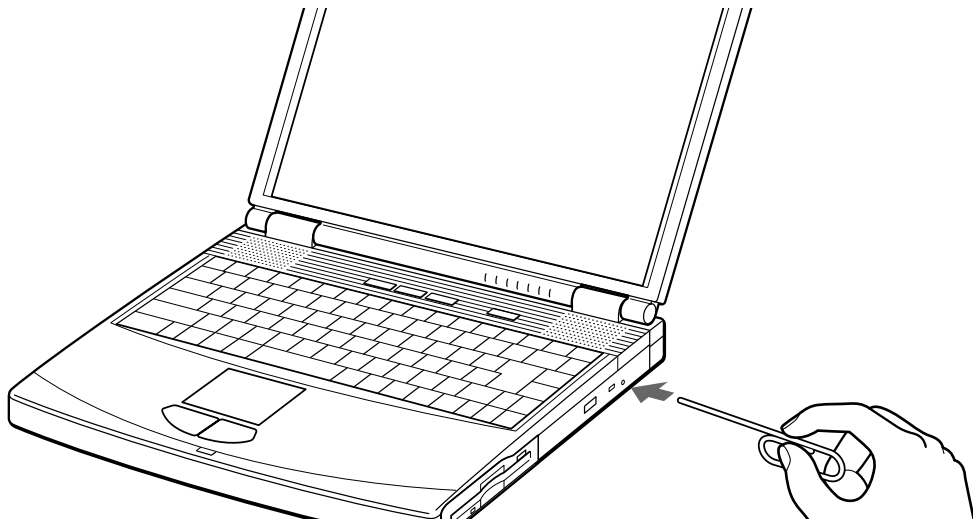



## Playing a DVD

To achieve optimum performance when playing DVDs, it is recommended that your computer not be connected to the port replicator while playing DVD movies or using DVD applications. Close any open applications before playing a DVD movie.

 When playing DVD movies on battery power, set the power management profile to DVD. With other profiles, the movies are choppy. As an alternative, you can set the power management profile to Automatic Profile Selection, which will cause the DVD profile to be selected automatically whenever you insert a DVD. See “Controlling Power Management” in the online manual “*Customizing Your VAIO® Notebook*” for information on how to set the power management profile.

- You can play DVDs using a DVD-ROM drive and the Media Bar software. See the online manual that came with the Media Bar software for details.

**Some discs recorded at 20 or 24 bits may produce noise while playing. If you have audio devices connected, this may cause damage to your hearing and the speakers. Reduce the volume before playing such discs.**

**You cannot switch between LCD and TV if you press Fn+F8 when a DVD is inserted in the DVD-ROM drive.**

If you have connected a TV, follow the instructions in “Selecting the Display Mode” in the online manual *Customizing Your VAIO® Notebook*.

When a TV is connected, a part of the video screen will not appear with the factory setting. Adjust the display resolution to 1024 x 768 as described in the online manual “*Customizing Your VAIO® Notebook*” .

### **Notes on CD and DVD media**

- ❑ Do not drop or bend the disc.
- ❑ Do not touch the surface of the disc. Fingerprints and dust on the surface of a disc may cause read errors. Proper care of the disc is essential to maintain its reliability. Do not use solvents such as benzine, thinner, commercially available cleaners or anti-static spray, as they may cause damage to the disc.
- ❑ For normal cleaning, hold the disc by its edge and use a soft cloth to wipe the surface from the center out.
- ❑ If the disc is badly soiled, moisten a soft cloth with water, wring it out well, and use it to wipe the surface of the disc from the center out. Wipe off any remaining moisture with a dry soft cloth

## Using PC Cards

Your computer includes two PC card slots. PC cards allow you to connect portable external devices such as another hard disk drive, or to connect a network.

 The PC card slots can accommodate two Type II PC cards, or one Type III PC card. These slots are compatible with Card Bus. Use the lower slot for Type III PC cards. You do not need to shut down your notebook before inserting or removing a PC card.

### To insert a PC card

- 1 Pull the PC card release button out from the computer, and then push it in toward the computer. This will extend the PC card slot protector.

#### PC card release lever

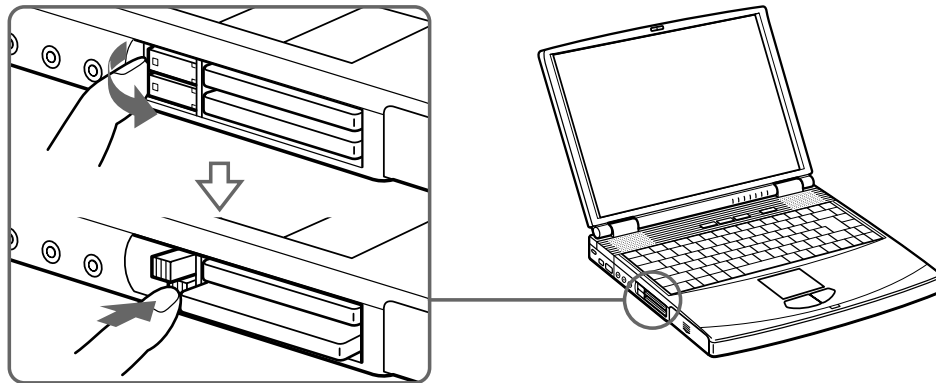

- 2 Remove the PC card slot protector.

When you use a Type III PC card, you need to remove both the top and bottom PC card slot protectors.

### PC card slot protector

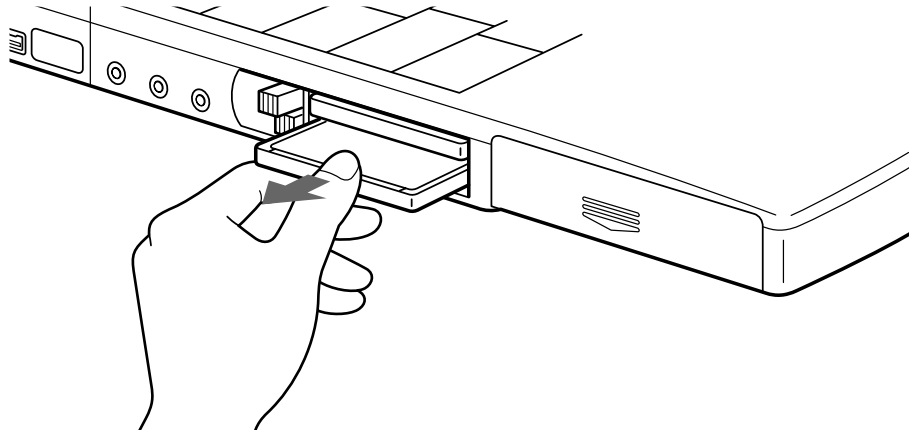

- 3 Insert the PC card into the PC card slot, front label facing up. Gently push the card into the slot until the card is fixed into the connector.
- 4 The release button extends. Fold the release button back down into the notebook.

### Inserting a PC card

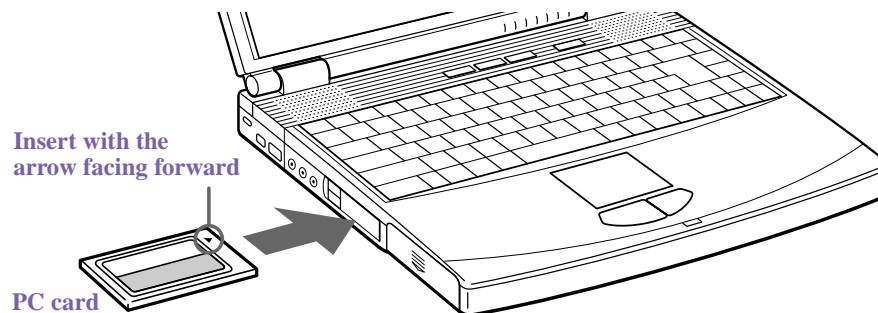

**Do not force a PC card into the slot as this may damage the connector pins. Do not carry your computer while touching the head of a PC card (such as a wireless LAN card), pressure or shock may damage the connector pins.**

## To remove a PC card

 If your computer is turned off, you do not have to follow these instructions.

- 1 Double-click  in the system task tray.
- 2 The “Unplug or Eject hardware” dialog box appears.
- 3 In the Unplug or Eject Hardware dialog box, select the appropriate option, and then click Stop.
- 4 Confirm the device and click OK.
- 5 A message appears informing you that the device can now be safely removed from the system.
- 6 Press the PC card RELEASE button to remove the PC card.

### Notes on using PC cards

- For some PC cards, if you alternate between normal power operation and the System Suspend or System Hibernation power-management modes while the card is inserted, you may find that a device connected to your system is not recognized. Reboot your system to correct the problem.
- Some PC cards may require that you disable idle devices when using the PC card. You can use Sony Notebook Setup to disable devices. See “Displaying the Sony Notebook Setup Screen” in the online manual “*Customizing Your VAIO® Notebook*” for details.
- Be sure to use the most recent software driver provided by the PC card manufacturer.
- If an “!” mark appears on the Device Manager tab in the System Properties dialog box, remove the software driver and then reinstall it.
- You may not be able to use some PC cards or some functions of the PC card with this computer. If you have difficulty inserting a card, check that you are orienting the card correctly. See the manual that came with your PC card for more information on use.

## Using Infrared Communication Devices

Your computer includes an infrared port, located on the left side. You can use this port to communicate with other infrared-equipped devices with compatible protocols, such as a digital still camera or other computers.

### To use infrared communication with another computer

- 1 Align the infrared ports on the two computers so that they are in a direct line.

### Connecting with Infrared

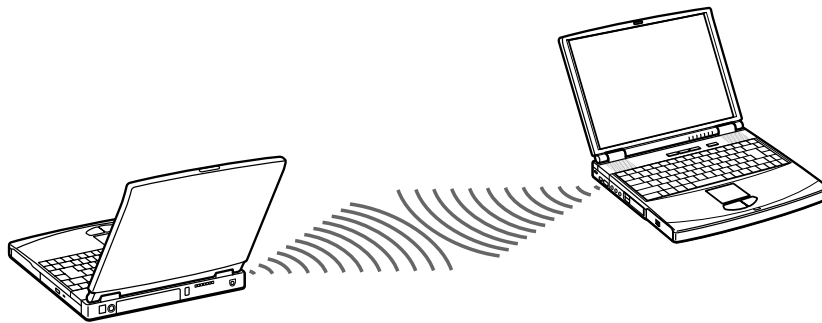

Infrared communication capability can be turned on and off. By default, it is disabled when your system is shipped. Use the infrared icon in the Windows Control Panel to enable/disable infrared communication.

### To enable infrared

- 1 Click Wireless Link icon in the Windows Control Panel.  
Wireless link dialogue box displays.
- 2 Select File Transfer Options Allow others to send files to your computer using infrared communications and/or Display status while receiving files.
- 3 Click OK.
- 4 Infrared Monitor icon appears in the task tray, open the monitor to verify that your computer has detected a nearby unit.
- 5 Once another unit is detected, your computer is ready to send/receive data.

## Infrared range

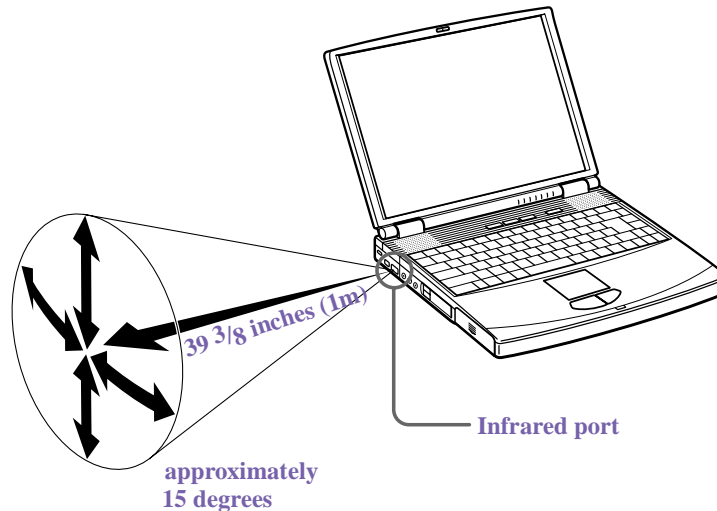

### Notes on using the Infrared Port

- If the devices are too far apart or too close together, data transfer may be interrupted or there may be noise in the transmission. The active area of infrared transmission extends about 39 <sup>3</sup>/<sub>8</sub> inches (1 meter) with a radius of approximately 15 degrees.
- Covering the infrared ports with your hand or any other object will disrupt data transfer.
- Avoid direct sunlight, fluorescent light, or flashing incandescent light near the infrared ports.
- Disable infrared communication when you are not using it to conserve battery life.

## Using a Second Battery Pack

You can purchase a second rechargeable battery pack. With two battery packs, you can extend the time that you use your computer with battery power. When using two battery packs, the battery pack you insert first charges first. The battery pack you insert second charges when the first battery pack is 85 percent full. You can monitor which battery pack is charging by observing the battery indicator lights.

### To insert a second battery pack

- 1 If another device is in the multipurpose bay, remove the device.
- 2 Insert the battery pack into the multipurpose bay.  
If the battery is being used, the battery 2 indicator light turns on.

### Second battery in multipurpose bay

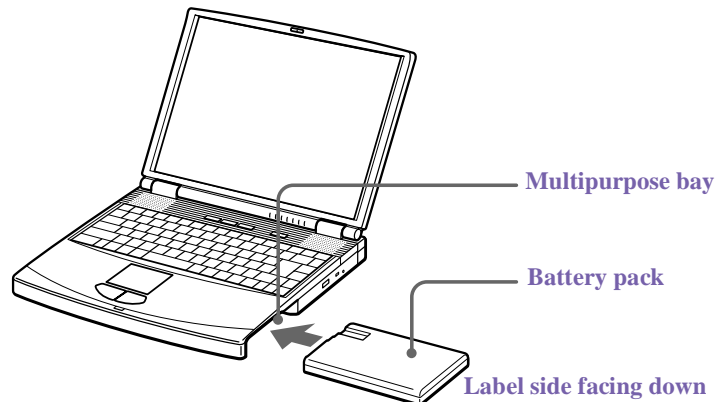

- 3 Attach the weight saver to the computer to stabilize the battery pack. There is a RELEASE lever on the bottom of the weight saver. Slide the lever toward the front of the computer to lock the weight saver. See also “Using the Weight Saver” on page 56.

### Using weight saver for second battery cover

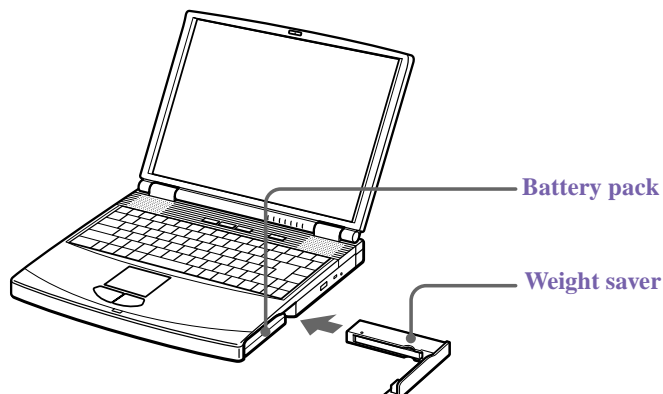



## To charge the second battery pack

Keep the battery pack in the computer while it is connected to AC power. The battery indicator flashes while the battery is charging. See also “To charge the battery pack” on page 27 for more information.

### Charging the second battery

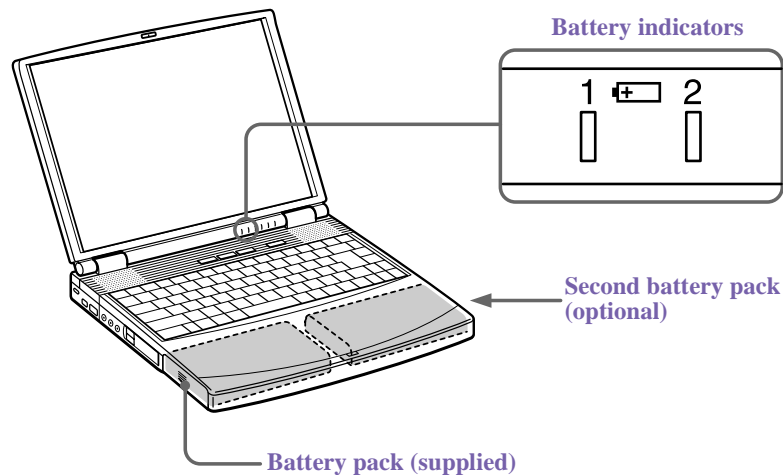

To determine the amount of time the battery lasts, see “Displaying Battery Information” in the online manual “*Customizing Your VAIO® Notebook*”.

## To remove the second battery pack

If you attach two battery packs, you can remove either of them without shutting down the computer. When removing one battery pack, make sure that the other battery pack’s indicator light is on. If the indicator light of the battery pack you are removing is on, right-click the battery icon on the task tray and click the “Switch discharge battery” option.

- 1 There is a Release lever on the bottom of the weight saver. To remove the battery pack, slide this lever in the direction of arrow 1, then slide the RELEASE lever on the bottom of the computer in the direction of arrow 2.

**Multipurpose bay release levers**

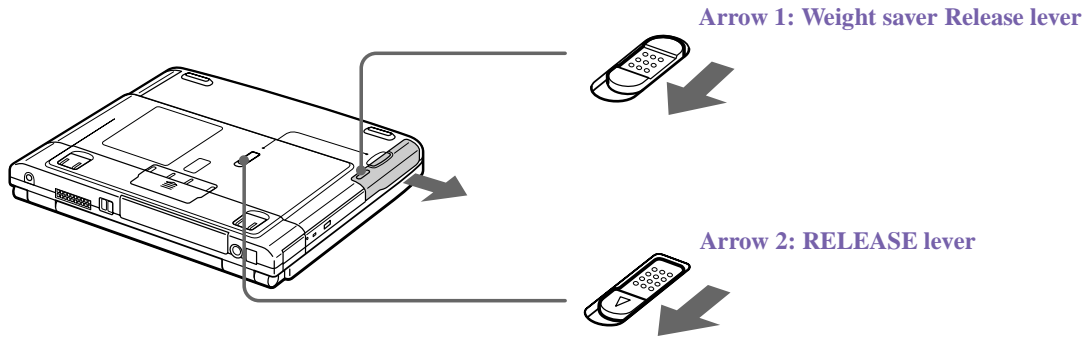

- 2 Remove the weight saver, and then pull out the battery pack.
- 3 Reinsert the weight saver. See “Using the Weight Saver” on page 56.

## Using the Weight Saver

The weight saver protects the multipurpose bay when it is empty.

### To attach the weight saver

- 1 If another device is in the multipurpose bay, remove the device. See “To remove the second battery pack” on page 54.
- 2 Fold out the hinged arm of the weight saver and then push on the hinged arm to lock it into place. Slide the weight saver in the direction of the arrow until it clicks.

### Inserting the weight saver

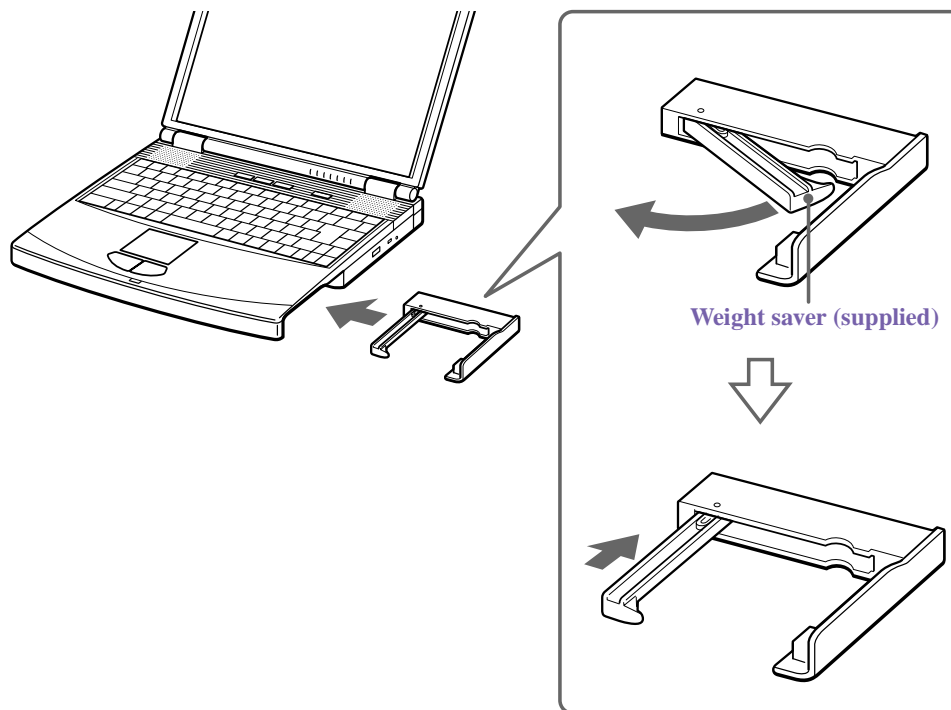

- 3 Manually lock the weight saver's Release lever.

### To remove the Weight Saver

- 1 There is a release lever on the bottom of the weight saver. To remove the weight saver, slide this lever in the direction of arrow 1, then slide the Release lever on the bottom of the computer in the direction of arrow 2.

### Multipurpose bay release levers

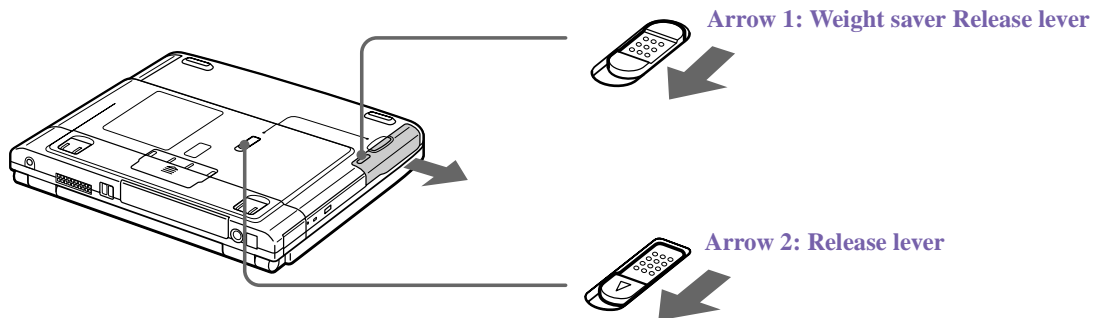

- 2 After removing the weight saver, pull out the weight saver's hinged arm and fold it into the weight saver.

## Using Smart Connect

### Windows Me™

You can connect your VAIO® notebook to another VAIO computer that has the preinstalled Windows Me operating system or the Sony Smart Connect 3.0 software preinstalled. You may use an i.LINK® cable (optional) to connect the two systems and then use one computer to edit, copy, or delete files on the other computer. You can also print from a printer that is attached to either computer. Select the STD mode in Smart Connect 3.0 software to connect with another computer that has Windows Me preinstalled.

### Connecting with an i.Link cable

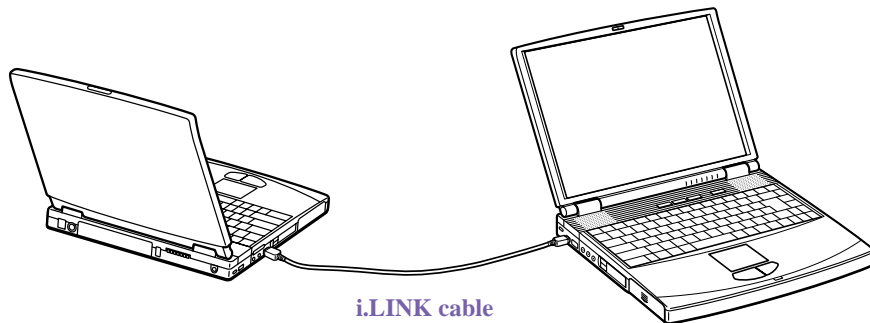

 When you connect two VAIO computers, you must assign each computer a unique name. The computers can be identified by this unique name when the two computers are networked together.

 If you have previously purchased a VAIO computer or notebook that does not have the Windows Me operating system or Smart Connect 3.0 software preinstalled, consult the Sony website for support options (<http://www.sony.com/pcsupport>).

# Connecting Peripheral Devices

You can add functionality to your computer by connecting any of these peripherals:

- i.LINK device (page 60)
- Phone line (page 62)
- Local Area Network (LAN) (page 63)
- Printer (page 63)
- Mouse or keyboard (page 65)
- External display (page 66)
- AV devices (page 69)
- Port replicator (page 70)
- Speakers (page 74)
- Microphone (page 75)
- Universal Serial Bus (USB) device (page 76)

## Connecting an i.LINK® Device

You can connect an i.LINK-enabled digital video camera recorder to the i.LINK® S400  (IEEE1394) connector.

### To connect a digital video camera recorder

- ❑ Plug one end of the i.LINK cable (not supplied) into the i.LINK connector on the left side of the computer and the other end into the DV In/Out connector on the digital video camera recorder.

 i.LINK cables compatible with your VAIO notebook include cables with the following part numbers: VMC-IL4415 (a 1.5-meter cable with a 4-pin connector at each end), VMC-IL4615 (a 1.5 meter-cable with a 4-pin connector at one end and a 6-pin connector at the other), and VMC-IL4408A (a 0.8-meter cable with a 4-pin connector at each end). You can purchase these cables from your local retailer, through the Sony VAIO® Direct Web site (<http://www.sonydirect.com/>), or by calling 1-888-315-7669 (toll free).

### Connecting digital video camera recorder to i.LINK connector

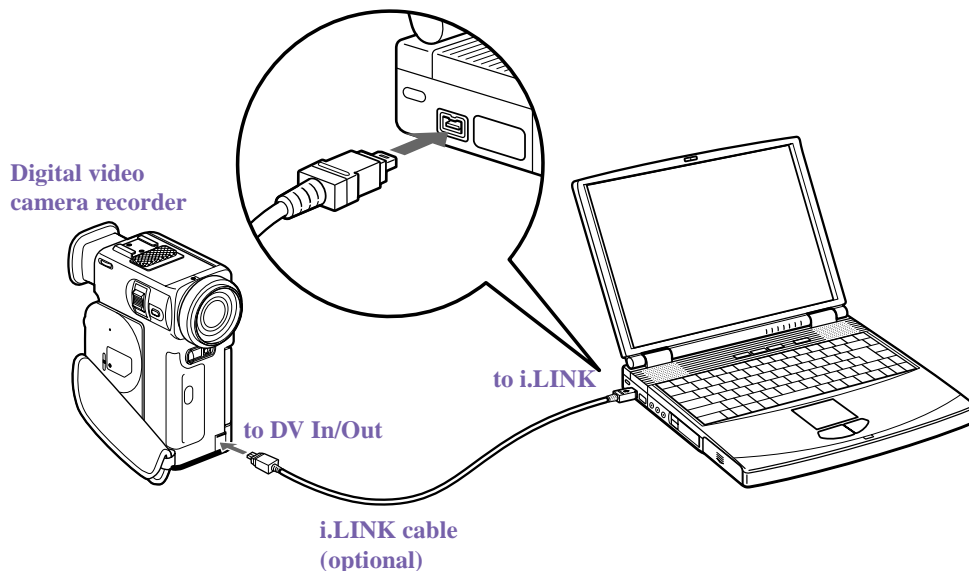

 The Sony digital video camera recorder is pictured; you may need to connect your camera differently.

On Sony digital video cameras, connectors labeled “DV In/Out” or “i.LINK” are i.LINK-compatible.

See the manual that came with your digital video camera recorder for more information on installation and use.

Do not connect more than one digital video camera at a time. The software supplied with your computer will not recognize multiple cameras.

The i.LINK connector on the computer does not supply power to external devices. If the external device requires power from the i.LINK connector, you cannot use the device with the computer.

The computer supports transfer rates up to 400 Mbps; however, the actual transfer rate is the lowest transfer rate of the external device.

The i.LINK features available may vary depending on the software applications you use. See the documentation that came with your software for more information.



## Connecting a Phone Line

You need to connect a phone line to take advantage of online services and the Internet.

 In order to register your Sony VAIO notebook, register your software online, and use Sony Customer Support, you must connect to a phone line.

- 1 Plug one end of the phone cable into the phone line jack on the computer.

### Connecting phone cable

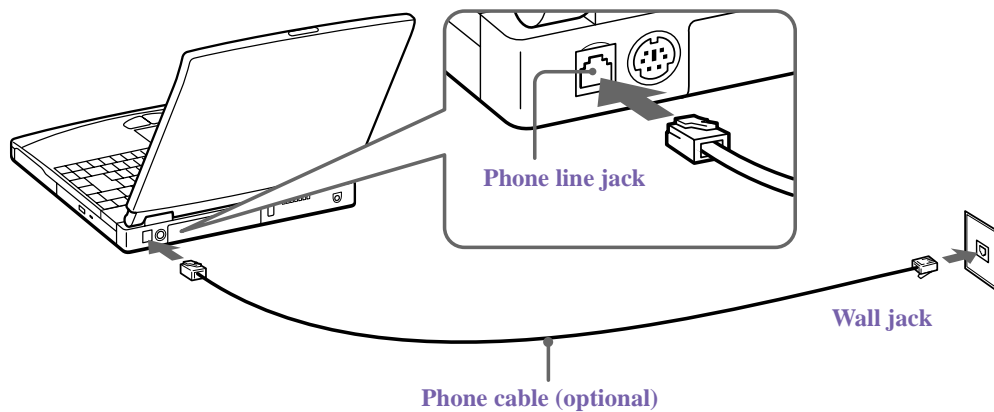

- 2 Plug the other end into the wall jack.

 Your computer does not work with party lines, cannot be connected to a coin-operated telephone, and may not work with multiple phone lines or a private branch exchange (PBX). Some of these connections may result in excess electrical current and could cause a malfunction in the internal modem.

If you connect a phone line coming through a splitter, the modem or connected device may not work properly.

## Using Ethernet to Connect to a Network

You can exchange data with other devices on a network by connecting your notebook to your Local Area Network (LAN).

To connect the notebook to a network, you need a network PC card or a port replicator (PCGA-PRF1A). For more information on using PC cards, see “Using PC Cards” on page 48 . Consult the network system administrator to find out about the accessory settings required to access the network.

### Setting Up Your Ethernet Connection

- 1 Right-click Network Neighborhood and select Properties.
- 2 Click Add to add a client, adapter, protocol, or service.
- 3 Click File and Print Sharing to enable these functions.
- 4 Select a Primary Network Logon.
- 5 Click the Identification tab to set the computer name, workgroup, and computer description.
- 6 Click the Access Control tab to set the share level or user level access control.

## Connecting a Printer

You can connect a Windows Me-compatible printer to your computer to print documents.

### To connect a printer

- Use the  symbol to locate the Printer connector. Plug the printer cable (supplied with the printer) into this port on the computer.

### Printer connector

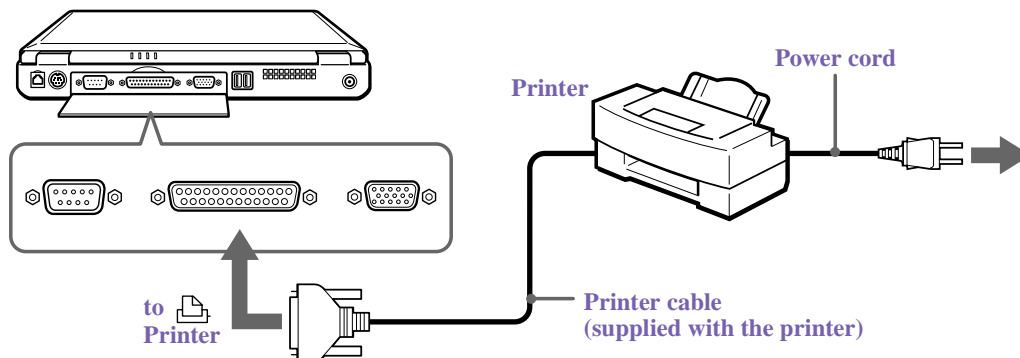

 See the manual that came with your printer for more information on installation and use.

If your printer stops functioning after resuming from a power-saving mode, see “Troubleshooting the printer” on page 111.

Before using the printer, you may need to change the Printer setting in the Sony Notebook Setup software. See “Displaying the Sony Notebook Setup Screen” in the online manual *“Customizing Your VAIO® Notebook”*.

## Connecting an External Mouse or Keyboard

You can connect a USB or PS/2® style mouse or keyboard.

Plug the keyboard cable or mouse cable into the appropriate connector with the  mark facing up.

### USB and PS/2 ports

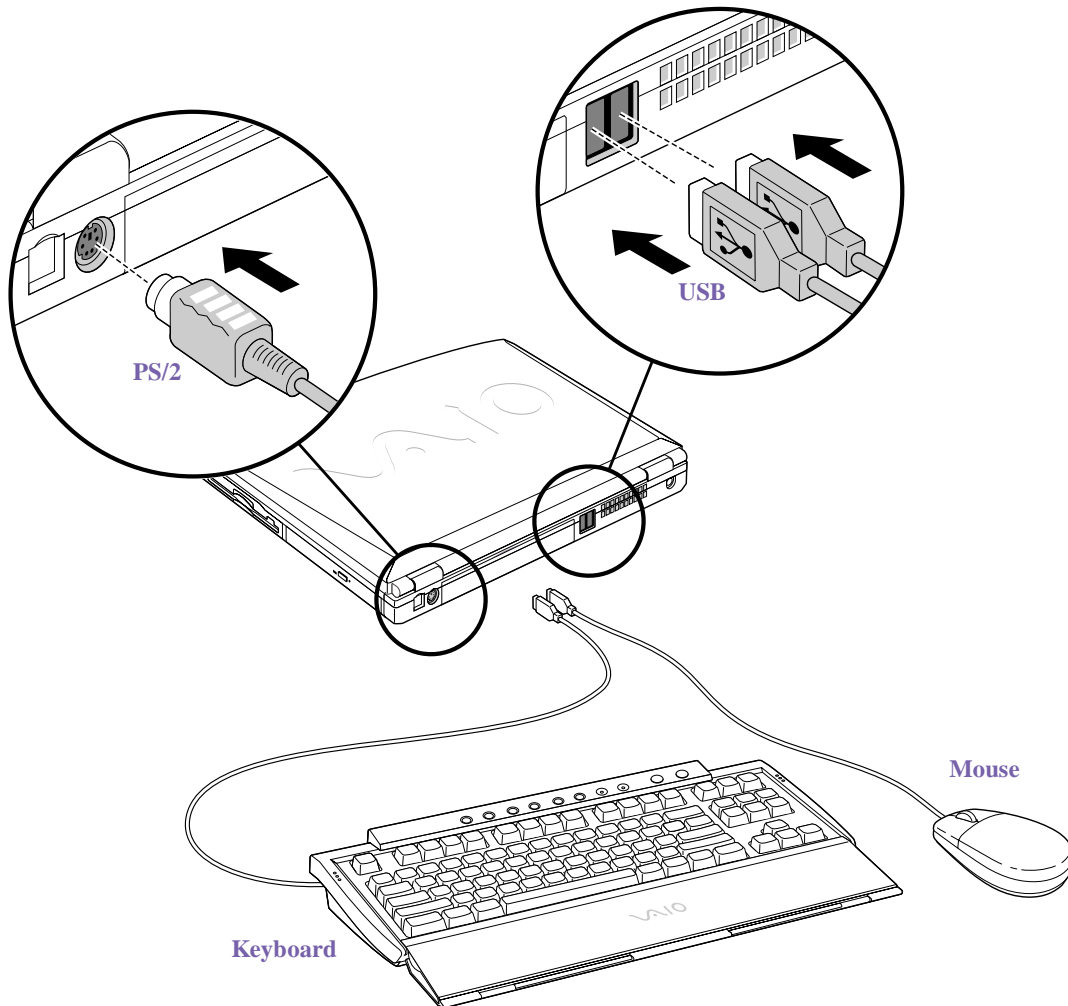

To connect both a PS/2 mouse and keyboard at the same time, use an optional PS/2 division connector.

You can also use one or both of the USB ports to connect a mouse and keyboard at the same time.

 See “Using the Keyboard” on page 33 for more information on using the keyboard.

See the manual that came with your mouse or keyboard for more information on installation and use.

Before you connect or disconnect the mouse or keyboard, turn off the computer.

Do not connect or disconnect the PS/2 device (keyboard or mouse) when the computer is on. It may cause malfunction.

A Sony USB mouse PCGA-UMS1 series(not supplied) is a USB device. You must connect it to the USB connector.

## Connecting an External Display

You can connect an external display to your notebook. For example, you can use the computer with any of the following:

- Computer display (monitor) (page 66)
- Multimedia computer display (page 67)
- Projector (page 67)

### To connect a computer display

- Use the  symbol on the back of the computer to locate the Monitor connector. Plug the display cable (not supplied) into this connector on the back of the computer.
- If necessary, plug one end of the display power cord into the display, and the other end into an AC outlet.

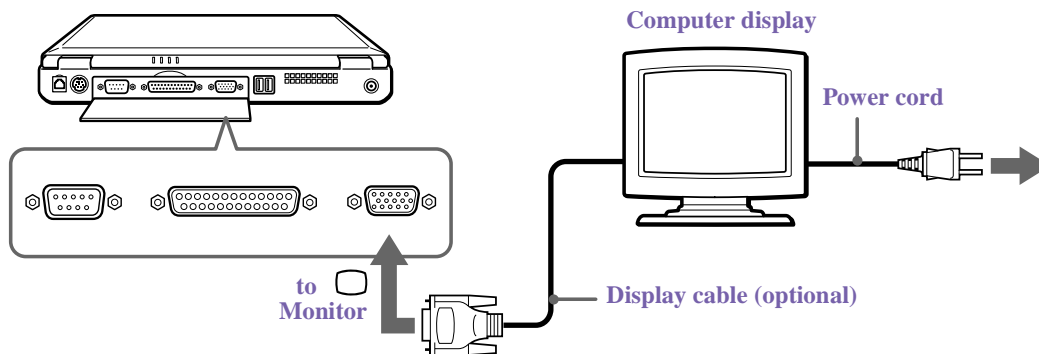

### Connecting an external computer display



 See the manual that came with your computer display for more information on installation and use.

### *To connect a multimedia computer display*

You can connect the notebook to a multimedia computer display that includes built-in speakers and a microphone.

- 1 Use the  symbol to locate the Monitor connector. Plug the display cable into this connector.
- 2 Use the  symbol to locate the Headphone connector. Plug the speaker cable into this connector.
- 3 Use the  symbol to locate the Microphone connector. Plug the microphone cable into this connector.

 See the manual that came with your multimedia computer display for more information on installation and use.

### *To connect a projector*

You can use a projector, such as the Sony LCD Projector, as an external display.

#### *Connecting projector*

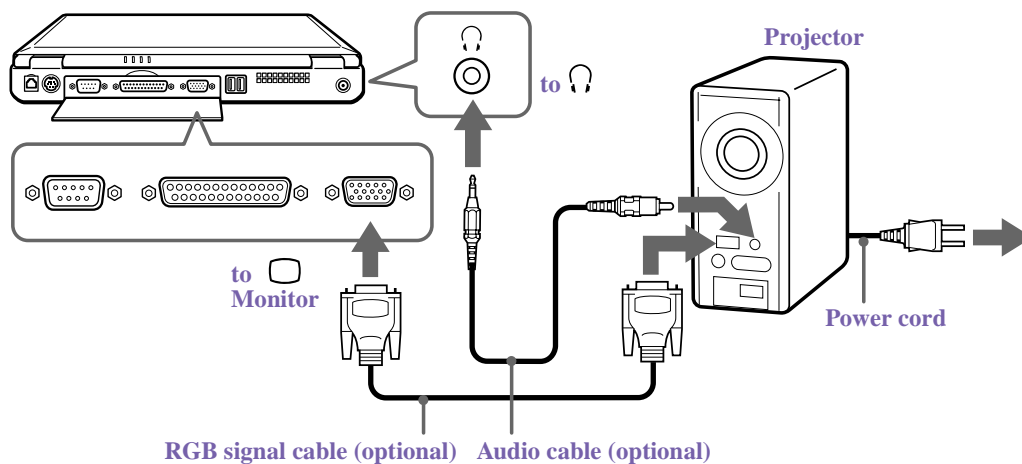

 See the manual that came with your projector for more information on installation and use.

### ***To select a display***

When you connect an external display to the monitor connector, you can toggle the output between the Liquid Crystal Display (LCD), the external monitor, or both devices.

Use the Fn+F7 keys to select a display. See also “Selecting the Display Mode” in the online manual “*Customizing Your VAIO® Notebook*” for more information.

---

<b><i>To</i></b>	<b><i>Press</i></b>	<b><i>Result</i></b>
Switch to an external display	Fn+F7	Toggles between the LCD, the external display connected to the Monitor connector, or both the LCD and external display.

---

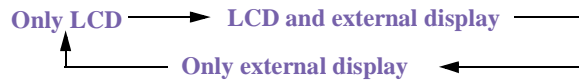

## AV Devices

You can enjoy playing audio/video by connecting AV devices to your computer. See also the manuals supplied with your AV devices.

### To Connect a TV

- ❑ Connect the computer to a TV using audio/video cables. Switch the input channel of the TV to external input. You also need to set up the TV configuration system.

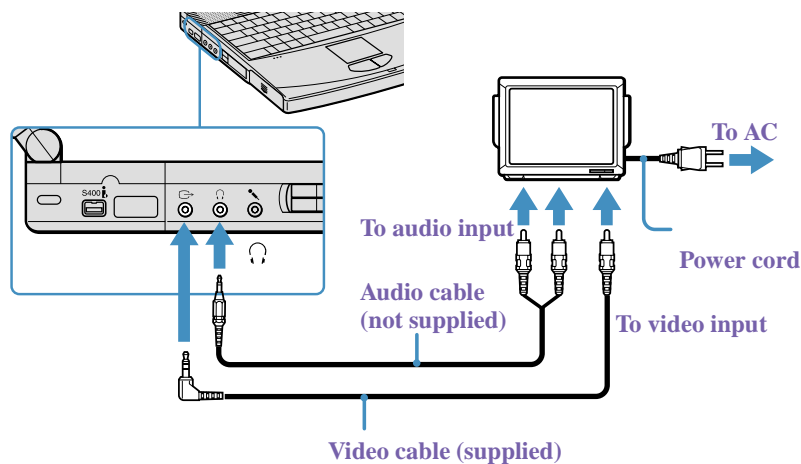

- ✍ See the manual that came with your peripheral device for more information on installation and use.
- ✍ If you insert a DVD in your DVD drive to watch a video on your TV, the Fn+F8 key combination might not activate the function to toggle between your LCD and TV. Take the following steps:
  1. Eject your DVD from your computer.
  2. Once the DVD is ejected, toggle between your LCD and your TV with the combination Fn+F8.

Your image displays now on both LCD and TV. Re-insert your DVD to launch you DVD software.



## Connecting the Port Replicator

Your notebook supports the use of an optional port replicator (PCGA-PRF1A). Attaching a port replicator enables you to connect additional peripherals to your computer.

### Port replicator

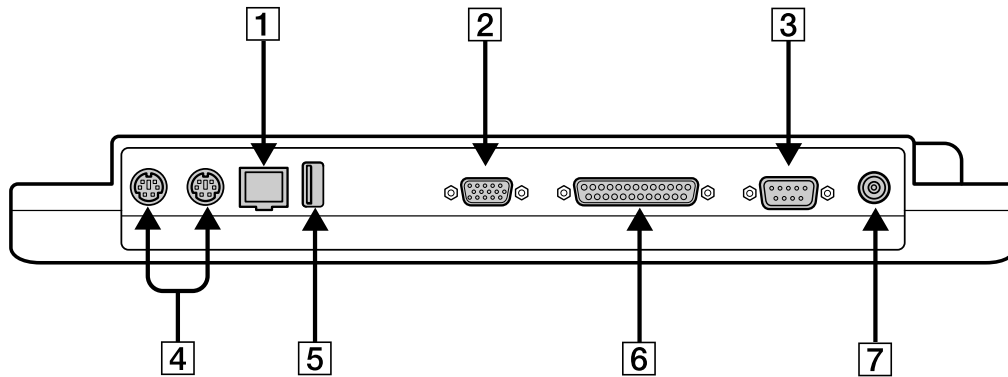

1	Network (Ethernet 10 Base T)	5	USB
2	Monitor	6	Printer
3	Serial	7	DC In
4	Mouse/Keyboard		

The port replicator can be powered only with an AC power adapter. Do not remove the AC adapter from the port replicator or the AC outlet while using the port replicator; this may cause data damage or hardware malfunctions.

When you attach your computer to the port replicator for the first time, the installation of the network driver starts automatically.

### To attach your computer to the port replicator

To supply power to your computer while it is connected to the port replicator, you can connect the AC adapter directly to the port replicator.

When attaching your computer to the port replicator, do not attempt to insert or remove the battery pack. Lifting and turning the computer with an attached port replicator could cause a temporary loss of power.

- 1 Turn off your computer and disconnect all peripheral devices.
- 2 On the bottom of the computer, slide the port replicator connector cover open.

**Port replicator connector**

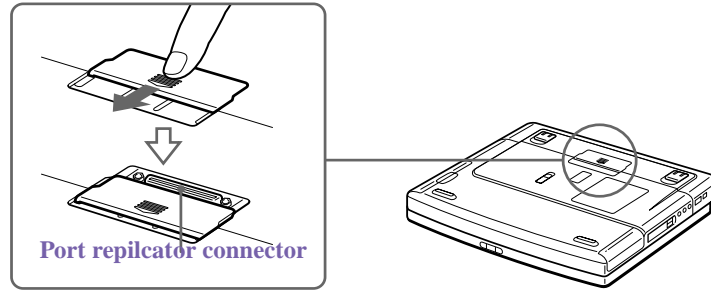

- 3 Attach the bottom of the computer to the port replicator connector until it clicks.

**Attaching computer to port replicator**

Notebook

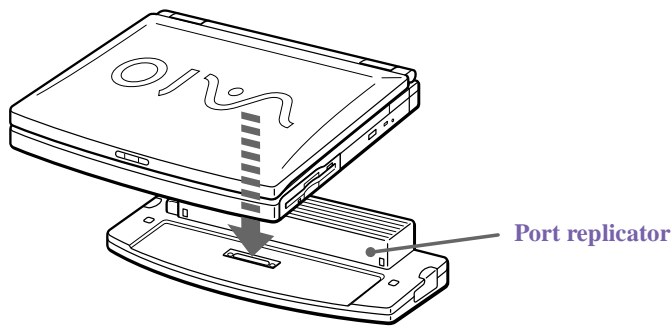

- 4 Plug the cable attached to the AC adapter into the **DC IN** connector on the port replicator. Plug the power cord into the AC adapter and an AC outlet.

### Connecting AC adaptor to port replicator

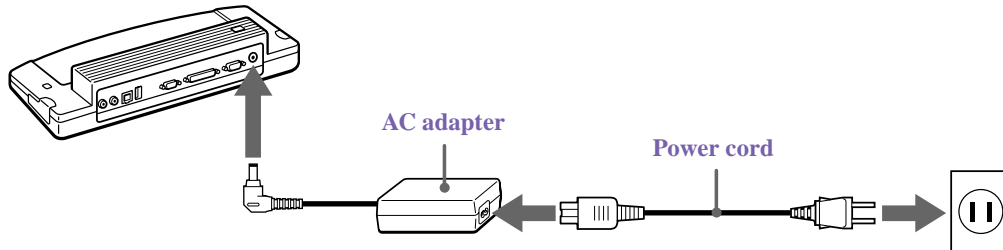

 Use the AC adapter that comes with your computer or the optional Sony PCGA-AC19V1 adapter.

The power indicator light turns green.

### Power indicator light

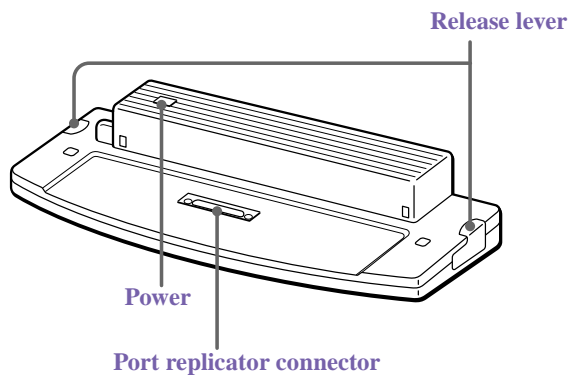

- 5 Turn on the computer.

**To remove your computer from the port replicator when the power is off**

- 1 Turn off your computer and the connected peripherals.
- 2 Pull the levers on each side of the port replicator to disengage the computer from the port replicator.

**Disengaging computer from port replicator**

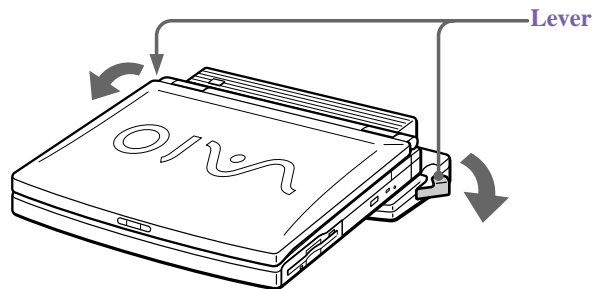

- 3 Lift the computer away from the port replicator.

**Port replicator connector cover**

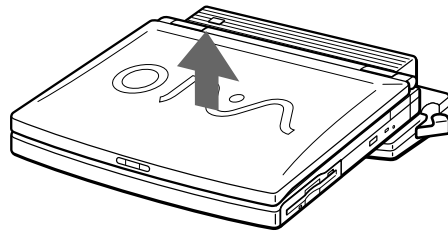

- 4 Close the port replicator connector cover on the bottom of your computer.

 It is extremely important to close the port replicator connector cover after removing your computer from the port replicator. If the cover is left open, dirt may get inside and damage the computer.

## Connecting External Speakers

You can enhance the sound quality of your computer by connecting external speakers.



Make sure your speakers are designed for computer use

Turn down the volume of the speakers before you turn them on.

Do not place diskettes on the speakers; the speakers' magnetic field may damage the data on the diskettes.

### To connect external speakers

- Use the  symbol to locate the Headphone connector. Plug the speaker cable into this connector.

### Connecting speakers to Headphone connector

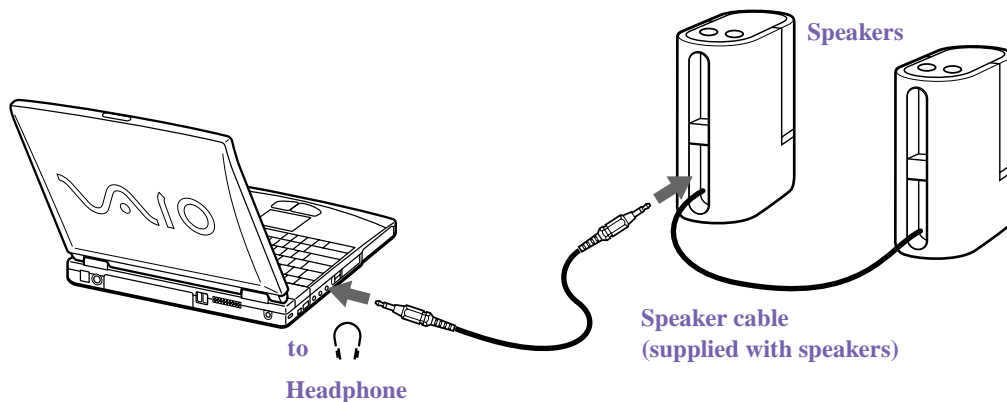

See the manual that came with your speakers for more information on installation and use.

## Connecting an External Microphone

You can enhance the quality of sound input by using an external microphone.

 Make sure your microphone is designed for computer use. The microphone should be compliant with the plug-in power microphone.

### *To connect an external microphone*

- Use the  to locate the Microphone connector. Plug the microphone cable into this connector.

### *Connecting a microphone to microphone connector*

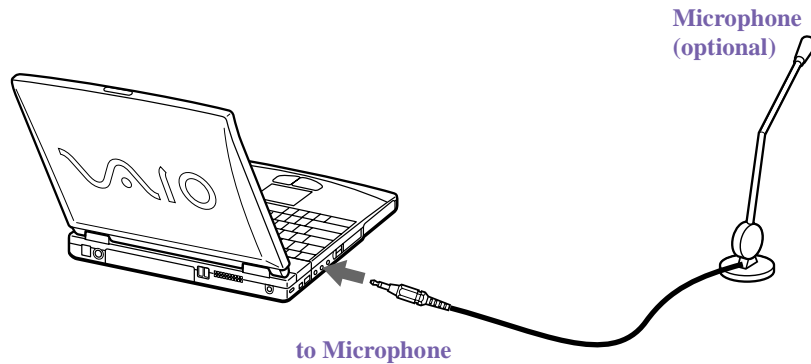

 See the manual that came with your microphone for more information on installation and use.

## Connecting a Universal Serial Bus (USB) Device

You can connect a USB device to your computer.

### To connect a USB device

- Use the  symbol to locate the USB connector. Plug one end of the USB cable into this port and the other end into the USB device.

### Connecting USB device to USB connector

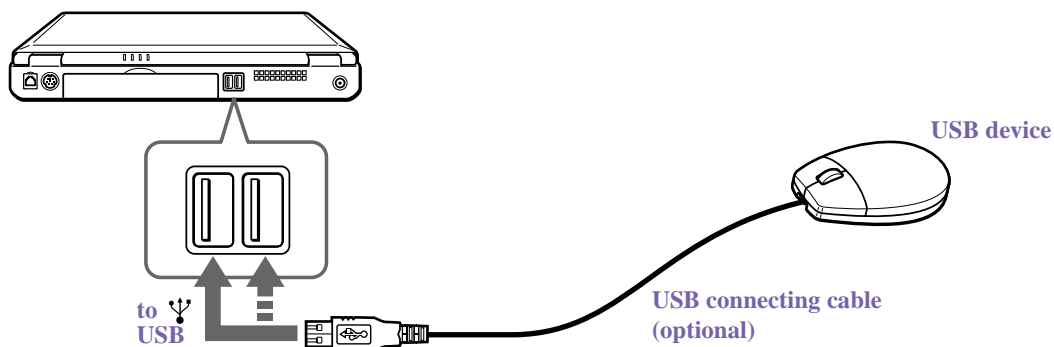

You can use the optional Sony USB mouse PCGA-UMS1 series with this computer. The USB mouse software driver is preinstalled in the computer. Therefore, you only need to plug the USB mouse into the USB connector.

 See the manual that came with your USB device for more information on installation and use.

# Power Saving Modes

When you use a battery as the source of power for your computer, you can take advantage of power management settings to conserve battery life. In addition to the normal operating mode, which allows you to turn off specific devices, your computer has three distinct power saving modes: System Idle, System Suspend, and System Hibernation. When using battery power, be aware that the computer automatically enters System Hibernation mode when the remaining battery charge drops below 5 percent, regardless of the power management setting you select.



If the battery level falls below 10 percent, you should either attach the AC adapter to recharge the battery or shut down your computer and insert a fully charged battery.

## **Normal Mode**

Normal mode is the normal state of your computer when it is in use. The power indicator light displays green when your computer is in this mode. To save power, you can turn off a specific device such as the LCD or the hard disk.

## **System Idle Mode**

Use the System Idle mode when your computer is not in use for a brief period. Selecting this option places your hard disk and video display in a low power state, and the CPU clock and processor stop. The power indicator light is amber in this mode.

## **To activate System Idle mode**

To activate System Idle mode, press the key combination Fn+S, or use the PowerPanel utility to activate the System Idle mode.

## **To return to normal mode**

Press any key to return to normal Mode.



## System Suspend Mode

In System Suspend Mode the computer saves the current state of the system in RAM and switches off power to the CPU. The amber power indicator light flashes in this mode.

### To activate System Suspend mode

To activate System Suspend mode, press the key combination Fn+Esc, or press the power button and release it immediately. You can also use the PowerPanel utility to enter System Suspend mode.

### To return to normal mode

Press any key to return to normal mode.

## System Hibernation Mode

In the System Hibernation mode, the state of the system is saved on the hard drive and power is turned off. The power indicator light is off in this mode.

### To activate System Hibernation mode

To activate System Hibernation mode, press the key combination Fn+F12.



Do not move the notebook until its power indicator light turns off.

### To return to normal mode

To return to normal mode, turn on the computer by pressing the power button. The computer returns to its previous state.



When returning from System Hibernation mode, the system status stored on the hard disk is erased and the computer starts normally if you press the power button and hold for more than four seconds.

- Time required to return to normal mode

System Idle requires less time than System Suspend, and System Suspend requires less time than System Hibernation to return to normal mode.

❑ **Power consumption**

System Idle uses more power than System Suspend, and System Suspend uses more power than System Hibernation.



# Adding Memory

In the future you may want to install memory modules to expand the functionality of your computer. For this model, 128 MB of memory is pre-installed (64 MB x 2). You can increase memory up to 192 MB (64 MB + 128 MB) or 256 MB (128 MB x 2), by replacing one or both memory modules in the memory module bay. Expansion memory modules are available as options. For memory upgrades, use only PC-100 SDRAM SO-DIMM (gold lead contacts).

**! Make sure you observe the proper safety precautions when you install memory modules in your computer. See the bulleted list below. Be careful when adding memory. Mistakes when installing or removing a memory module may cause a malfunction.**

## *Before you start*

- ❑ The procedures described below assume you are familiar with the general terminology associated with personal computers and with common safety practices required for using and modifying electronic equipment.
- ❑ Disconnect your system from its power source and from any telecommunications links, networks, or modems before you open the system or follow any of the procedures described below. Personal injury or equipment damage may result from failure to take these precautions.
- ❑ Electrostatic discharge (ESD) can damage memory modules and other components. Perform the procedures described below only at an ESD workstation. If such a station is not available, do not work in a carpeted area, and do not handle materials that produce or hold static electricity (cellophane wrappers, for example). Ground yourself by maintaining contact with an unpainted metal portion of the chassis while performing the procedure.
- ❑ Do not open the memory module package until you are ready to install the module. The package protects the module from ESD.
- ❑ Use the special bag for preventing ESD or use aluminum foil when you store the memory module.

### Typical expansion memory configuration

Total System Memory (MB)	Slot 1 (MB)	Slot 2 (MB)
128	64	64
192	64	128
256	128	128

### To remove a memory module

- 1 Shut down your computer and disconnect all peripheral devices, such as your printer.
- 2 Unplug the computer and remove the battery pack(s).
- 3 After the computer has cooled, loosen and remove the screw that secures the cover of the memory bay on the bottom of your computer. Use an appropriate screwdriver.

### Removing the memory module cover

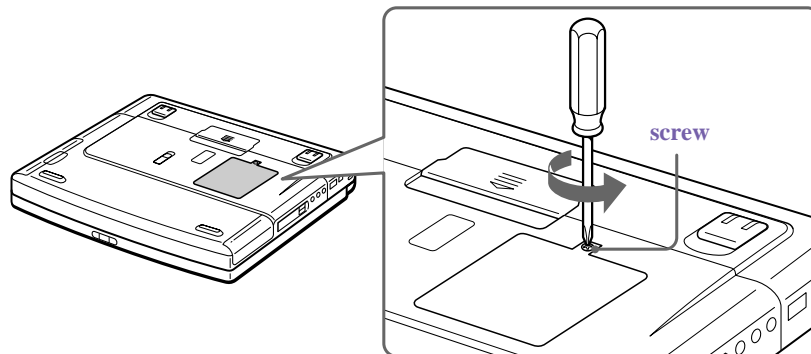

- 4 Touch a metal object (such as the connector panel on the back of your computer) to discharge any static electricity.

- 5 Remove the memory module.

### *Removing memory module*

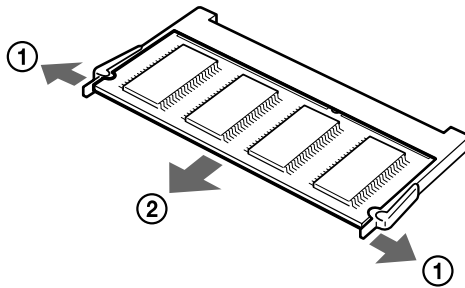

- 1 Pull the tabs in the direction of the arrows. The memory module is released.      2 Pull the memory module in the direction of the arrow.

- 6 Tighten the screw on the memory bay cover.



Your computer comes with a memory module installed in the memory slot. To upgrade your memory, remove this module from the slot before installing your upgrade memory module.

### *To install a memory module*

- 1 Follow steps 1 to 4 of “To remove a memory module.”
- 2 Remove the memory module from its packaging.

- 3 Install the memory module.

### *Installing memory module*

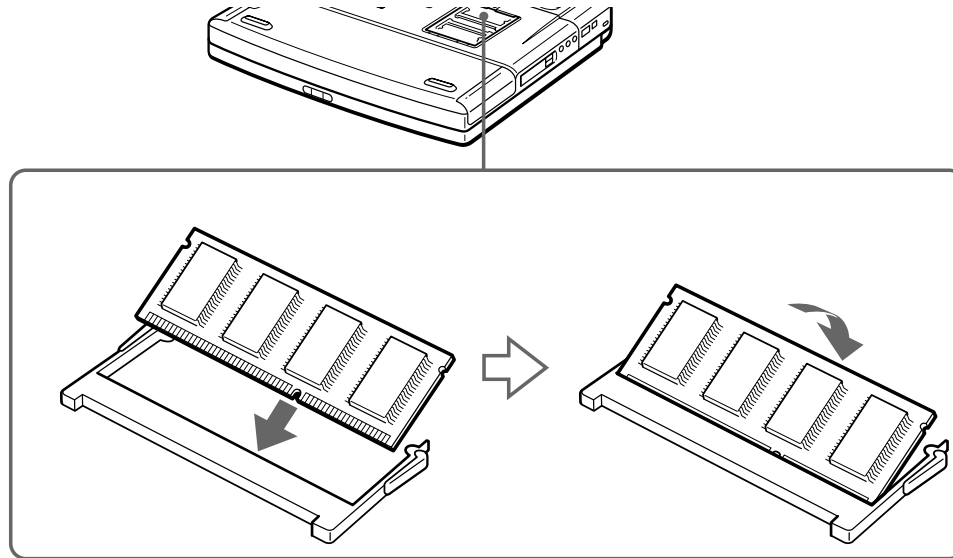

1 Slide the memory module into the slot.

2 Press the module into place until it clicks.

- 4 Tighten the screw on the cover of the memory bay.

### *To view the amount of memory*

- 1 Restart the computer.
- 2 Click the Start button on the Windows status bar, point to VAIO option, and click “Sony Notebook Setup.”

The Sony Notebook Setup screen appears.

- 3 Click the “About This Computer” tab to view the amount of system memory. If the additional memory is not shown, repeat steps 1 through 4 in “To install a memory module.”

# About the Software on Your Notebook

Your VAIO notebook is ready to help you work, play, learn, and communicate as soon as you turn it on. This section gives you an overview of the activities you can perform with your software titles. For support information, see “For Answers to Your Software Questions” on page 94.

## **Adobe Acrobat Reader®**

*Adobe Systems Inc.*

Acrobat Reader software allows you to view, navigate, and print electronic documents in Adobe Portable Document Format (PDF), an open file format that is intended to preserve the fidelity of documents created on all major computer platforms.

## **Adobe PhotoDeluxe® Home Edition**

*Adobe Systems Inc.*

Create amazing photo effects with Adobe PhotoDeluxe. Without learning complex software, you can enhance, restore, and be creative with your photos. Includes built-in guided activities, stock photos, clip art and templates to assist you.

## **Adobe Premiere® LE**

*Adobe Systems Incorporated*

Adobe Premiere LE offers an interface and editing tool for producing movies for video, multimedia, or the Web. View source clips and edited footage simultaneously on the monitor window. Create video clips up to three hours long with complete audio-video synchronization.

## **America Online®**

*America Online*

America Online is a popular Internet online service. Stay in touch with family and friends with easy-to-use e-mail, manage your personal finances, get the latest news and sports scores, and chat with thousands of others who share your interests.



### **ArcSoft® PhotoPrinter™ 2000 Pro**

*ArcSoft, Inc.*

ArcSoft PhotoPrinter 2000 is an easy-to-use, advanced printing program that lets you quickly lay out multiple images in multiple sizes on a single sheet of paper. PhotoPrinter Pro offers a wide selection of templates including landscape, portrait, free style, mixed sizes, custom templates and more. The application includes enhancement tools and special effects for improving photos while giving you the ability to add text to any image.

### **CompuServe® 2000**

*CompuServe, Inc.*

CompuServe is the most comprehensive source of organized business and educational information online today. CompuServe allows you to access the vastness of the Internet, without wasting time wading through it. Maximize your time online with CompuServe.

### **DVgate™**

*Sony Electronics*

Connect a digital video camera recorder to the i.LINK® connector and capture your own video clips and still images. You can edit clips from your video, add others, and combine clips into new movie segments. You can also save your images in a variety of popular file formats.

### **EarthLink Network TotalAccess®**

*EarthLink Network, Inc.*

An Internet Service Provider that supplies access, information, and assistance to its customers, introducing them to the Internet. Member benefits include e-mail, newsgroups, a personal start page, a free 6 MB web site, a member newsletter, and 24-hour technical support.

### **McAfee® VirusScan®**

*Network Associates, Inc.*

Protect your computer from viruses. VirusScan can detect viruses from floppy disks, Internet downloads, e-mail attachments, intranets, shared files, CD-ROMs, and online services.

## **Media Bar™**

*Sony Electronics*

Media Bar software is your all-in-one solution for audio/video playback. Media Bar software handles all common computer multimedia formats and controls selected Sony devices. In addition to audio/video library cataloging and playlist management, Media Bar software includes digital video quality control and effects features. Media Bar software seamlessly integrates a variety of new media formats with an easy-to-use software interface.

## **Microsoft® Internet Explorer**

*Microsoft Corporation*

Internet Explorer delivers the web the way you want it. It is safe, easy to use, and you can personalize how you access the web. Outlook Express and other tools in Internet Explorer also help you have a great experience when you are on the web.

## **Microsoft® Word 2000**

*Microsoft Corporation*

Microsoft Word 2000 makes it easy to create shared Web, e-mail, and print documents for use around the world. It embraces HTML as a first-class file format and extends Word's ease-of-use to the Web and e-mail. Word 2000 also extends that ease-of-use to international users, making it simple to create multilingual documents.

## **MovieShaker™**

*Sony Electronics*

Sony's original MovieShaker software creates personal movies that have transitions, background music and text. Just import your video clips and "shake" with a click of the mouse. Your personal movies are easy to create and fun to share with family and friends.

## **Netscape Communicator®**

*Netscape Communications*

Netscape Communicator is an all-in-one Internet tool that makes it easy to browse the web, send Internet e-mail, chat, read newsgroups, and compose great web documents.

## **PictureGear™**

*Sony Electronics*

This image management software displays images from your hard drive, a Sony digital still camera, or a Sony Mavica® camera. The images appear in a convenient light-table format, so that you can easily view the contents of an entire folder.

### **Prodigy Internet®**

*Prodigy Communications Corporation*

An online service that helps you find what you need online faster and smarter. Prodigy delivers powerful online content such as sports scores, stock quotes, news, and easy access to Excite, plus quality customer service, all at a competitive price.

### **Quicken® Basic 2000**

*Intuit, Inc.*

Quicken is a fast, easy way to organize your finances. Quicken works just like your checkbook, so it is easy to learn and use. Quicken manages all your finances, bank accounts, credit cards, investments, and loans. You can even pay your bills online.

### **Smart Capture**

*Sony Electronics*

Smart Capture is a fun new way to send multimedia messages via e-mail. Smart Capture manages the i.LINK® connection between your computer and a Sony Digital Handycam® Camcorder that supports the i.LINK interface. It allows you to capture compressed video or still images that you can save or share via e-mail. A smart solution to computer, digital audio/video and network convergence.

### **Sound Forge® XP**

*Sonic Foundry*

Sound Forge XP allows you to put powerful audio processing tools and effects to work on your notebook. Simply cut, copy, and paste your way to striking multimedia files for use in everything from Web pages to desktop presentations.

# About Your Software

## MovieShaker™

This application can be used to create fun and innovative movies without any knowledge of film editing. In a few simple steps, motion pictures can be combined with special effects, still images (pictures), and music files and then saved in a format most computers can play.

### Main Window

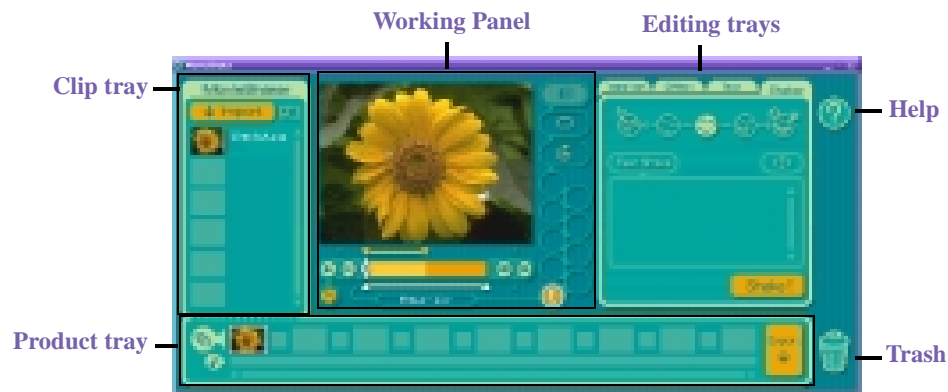

### Importing Images and Sound Clips

- 1 Click  .
- 2 Find the file you want to add.
- 3 Select the file.
- 4 Click Open. The file is added to the Clip tray.

 Importing files over 75 seconds in length may cause MovieShaker to stop responding.

## Create a Movie using Shaker

After adding clip(s) to the Clip tray, you can create a short movie using the Shaker feature. Shaker randomly select clips from the Clip tray to create a 30-second scene.

- 1 Click the Shake tab.
- 2 Select a mood by clicking a face in the Shaker tray.

### Shaker Tray



- 3 Click **Shake !**. A thirty second scene is automatically generated and saved to the Product tray.
- 4 To preview, switch the Work Panel to Product tray mode and press play.

 Scenes created with Shaker begin with black frame and after processing are placed in the first available slot on the Product tray. Limit the number of scenes placed on the Product tray to 10 or less. MovieShaker may stop responding if too many scenes are placed on the Product tray.

## Editing Clips and Scenes

You can edit your movie by adding effects and text, adjusting the color and contrast, and modifying the length of clips.

### Working Panel



Adding effects to a scene or a clip:

- 1 Double-click the clip or scene to move it to the Working Panel.
- 2 Select the Effects tab from the Editing tray.
- 3 Drag and drop the Effect you want to add from the Effects tray to the Effects palette on the Working Panel.

 To preview an Effect, click on the clip in the Working panel monitor. Your clip displays with the new effect on the Effect tray monitor.

- 4 See help for instructions on adjusting effect duration and replaying clips/scenes.

## Saving a Movie

- 1 Verify that the clip(s) you want to save is on the Product tray. See Help for more details on saving movies.
- 2 Click Export.

- 3 Select the format in which you want the document to be saved.
- 4 Click Next.
- 5 Locate the folder to which you want the file saved.
- 6 Name the file.
- 7 Click Save.

**!** Exporting movies may take a long time to complete—Save movie as DV (Digital Video) takes the longest and Quick-Save is the fastest. MovieShaker can play video files up to 65 MB in length.

 For DV playback and smooth video playback, we recommend the following resolution/refresh rates: 1024 x 768/75 Hz or lower.

## PictureGear™

PictureGear is a digital image management application that allows you to see all the images stored in any directory on your computer. Thumbnail views provide quick reminders of your pictures. Brighten, contrast, enhance, resize, crop, and color-correct your pictures. Create panoramic views, animations, screen savers, wallpaper, still pictures from MPEG, and even html photo albums.

### Managing Your Pictures

Use the collection feature to manage your pictures.

- 1 Click the Folder tab and browse to locate your pictures.
- 2 Select the pictures you want to have in a collection.
- 3 From Collection menu, select Create New Collection.
- 4 Enter a name for the collection and then click okay.

### Creating a Photo Album

- 1 Select the pictures you want to use to make an album.
- 2 From the Utilities menu, select Album Maker.
- 3 Choose the type of Album you want and click Okay.

- 4 Now add more pictures, frames, text, and effects.
- 5 When you are finished, select Create Album in File menu or click the Create Album icon on the toolbar.
- 6 Designate the folder you where want to save the Album.
- 7 Enter the Target Album name, select Thumbnails and click Okay.
- 8 The new album can be viewed using most internet browsers.

### ***Using Panorama Maker***

Panorama Maker stitches a group of still images into a 360 degree panoramic picture. The source images should be the same size and overlap 20%.

How to stitch a panoramic picture:

- 1 Gather the source images into the same folder or collection.
- 2 Select the images you want to use.



We recommend 12 landscaped or 16 portrait pictures.

- 3 From the Utilities menu select Panorama Maker.
- 4 Select the correct lens and click Okay. (If 35mm lens is selected the prompt, does not appear; to select a different lens, click the lens icon.)
- 5 Click the panoramic icon, near the bottom of the window.
- 6 Click Full Stitch.

### ***Making Still Images and Panoramic from MPEG***

- 1 Select the MPEG file.
- 2 From the Movie/Sound menu, select Scene break down.
- 3 Then select Movie Stitch, to create a panoramic picture.



## About Your Recovery CDs

### Application Recovery CD(s)

*Sony Electronics*

This program allows you to reinstall individual applications and device drivers. Use it to restore corrupted or accidentally erased files.

### System Recovery CD(s)

*Sony Electronics*

This program allows you to restore the software titles that shipped with your computer if they become corrupted or are erased accidentally. It can be used only to restore the hard disk of this Sony computer.

## For Answers to Your Software Questions

### Acrobat® Reader, Adobe PhotoDeluxe® Business Edition, Adobe Premiere® LE (Adobe Systems Incorporated)

---

Web site	<a href="http://www.adobe.com/">http://www.adobe.com/</a>
phone	206-628-2746 (fee-based support)
fax	206-628-5737
e-mail	<a href="mailto:techdocs@adobe.com">techdocs@adobe.com</a>
hours	M-F, 6 AM-5 PM PT

---

### America Online® (America Online)

---

Web site	<a href="http://www.aol.com">http://www.aol.com</a>
phone	800-827-3338
hours	7 days a week, 24 hours a day

---

### CompuServe® 2000 (CompuServe, Inc.)

---

Web site	<a href="http://www.compuserve.com">http://www.compuserve.com</a>
phone	800-848-8990

---

### **EarthLink Network TotalAccess® (EarthLink Network, Inc.)**

---

Web site	<a href="http://help.earthlink.net/techsupport/">http://help.earthlink.net/techsupport/</a>
phone	800-395-8410
e-mail	<a href="mailto:support@earthlink.net">support@earthlink.net</a>
hours	7 days a week, 24 hours a day

---

### **McAfee® VirusScan® (Network Associates, Inc.)**

---

Web site	<a href="http://support.mcafee.com">http://support.mcafee.com</a>
phone	408-988-3832
e-mail	<a href="mailto:cybr@nai.com">cybr@nai.com</a>
hours	M-F 9AM-5PM Central Time

---

### **Netscape Communicator® (Netscape Communications Corporation)**

---

Web site	<a href="http://www.netscape.com/">http://www.netscape.com/</a>
phone	888-4SONYPC (888-476-6972)*
hours	7 days a week, 24 hours a day

---

\* Support from 1-888-4SONYPC is free of charge for 90 days after the original date of purchase.

### **PhotoPrinter™ 2000 Pro (ArcSoft, Inc.)**

---

Web site(s)	<a href="http://www.arcsoft.com">http://www.arcsoft.com</a> <a href="http://www.photoisland.com">http://www.photoisland.com</a>
phone	510-440-9901
fax	510-440-1270
e-mail	<a href="mailto:techsupport@arcsoft.com">techsupport@arcsoft.com</a>
hours	M-F, 8:30 AM-5:30 PM PT

---

### **Prodigy Internet® (Prodigy Communications Corporation)**

---

Web site	<a href="http://www.prodigy.com">http://www.prodigy.com</a>
phone	800-213-0992
hours	7 AM - 3 AM ET

---

### **Quicken® 2000 (Intuit Inc.)**

---

Web site	<a href="http://www.intuit.com/support">http://www.intuit.com/support</a>
phone	900-555-4688
hours	7 days a week, 24 hours a day

---

### **Windows Me Operating System, Internet Explorer (Microsoft Corporation)**

---

Web site	<a href="http://www.microsoft.com/support/">http://www.microsoft.com/support/</a>
phone	888-4SONYPC (888-476-6972)*
hours	7 days a week, 24 hours a day

---

\* Support from 1-888-4SONYPC is free of charge for 90 days after the original date of purchase.

### **WinFax™ Basic Edition (Symantec Corporation)**

---

Web site	<a href="http://www.symantec.com/techsupp/">http://www.symantec.com/techsupp/</a>
phone	800-798-0850
fax	800-554-4403 in North America 541-984-2490 outside North America

---

### **Sony Service Center**

For the Sony Service Center nearest you, call 1-888-4SONYPC (1-888-476-6972) or find Sony Customer Service on the Web at <http://www.sony.com/pcsupport>.

## Using the System and Application Recovery CDs

The following sections describe how to use the System Recovery and Application Recovery utilities.

### Using the System Recovery CD(s)

You can reinstall software titles that shipped with your computer if they are corrupted or erased. You may not need to recover the entire contents of your hard drive. If you experience a problem with your computer, reinstalling an individual device driver or software title may correct the problem. Use the Application Recovery CD(s) to reinstall individual applications or device drivers. See “Using the Application Recovery CD(s)” on page 98.

The System Recovery CD contains a backup copy of all the software originally installed on your hard disk drive. **It can be used only to recover the hard disk of the notebook you purchased.**

The System Recovery utility gives you Full Restore with Format—formats the hard disk drive and then restores all the original software.

**! Full Restore with Format removes all the information on the hard disk drive. You will lose any software you have installed and any other files you have created since you started to use your computer. This means you will have to reinstall any applications that were not included with the computer when you purchased it. If you have any questions on using the System Recovery CD, contact Sony Customer Support.**

### To use the System Recovery CD(s)

- 1 Insert the Sony System Recovery CD in the DVD-ROM drive.
- 2 Shut down your computer as described in “Shutting Down Your Computer” on page 32.
- 3 Wait four seconds and turn on your computer.
- 4 Click OK to signify you have read and accept the Microsoft End-User License Agreement.
- 5 When the System Recovery menu appears, follow the on-screen instructions to complete the recovery process.

 Your system may include one or two System Recovery CDs. If you have two System Recovery CDs, insert the first CD to run the System Recovery program. You are prompted to insert the second CD once the information from the first CD has been installed.

The recovery process takes from 30 to 60 minutes to complete.

After recovering your system using the SRCD, you may be prompted to insert your ARCD after restarting Windows. Insert the ARCD to automatically complete recovery of your system.

### ***If your computer does not start from the Recovery CD***

- 1** Press the power button and hold it for more than four seconds to turn off the computer.
- 2** Turn on the computer. When the Sony logo is displayed, press the F2 key. The BIOS setup menu screen appears.
- 3** Press the arrow keys to select the Exit menu.
- 4** Press the arrow keys to select “Get Default Values” and then press the Enter key. The message “Load default configuration now?” appears.
- 5** Check that “Yes” is selected, then press the Enter key.
- 6** Press the arrow keys to select “Exit” (Save Changes) and then press the Enter key. The message “Save configuration changes and exit now?” appears.
- 7** Check that “Yes” is selected, then press the Enter key. The computer restarts from the Recovery CD.

### ***Using the Application Recovery CD(s)***

The Application Recovery CD(s) allows you to reinstall individual applications and device drivers if they are corrupted or accidentally erased. Reinstalling an individual device driver or software title may correct a problem you are experiencing with your computer, and you may not need to recover the entire contents of your hard drive. If you do need to reinstall all the software titles that shipped with your computer, use the System Recovery CD(s). See “Using the System Recovery CD(s)” on page 97.

You can also use the Application Recovery CD to install Windows Millennium drivers on your computer.

 You must be in Windows to run the Application Recovery CD. If you have any questions on using the Application Recovery CD, contact Sony Customer Support.

### *To use the Application Recovery CD(s)*

- 1** Turn on your computer. If your computer is already on, close all applications.
- 2** When the Windows desktop appears, insert the Sony Application Recovery CD in the DVD-ROM drive. The Application Recovery utility loads automatically.
- 3** When the Application Recovery menu appears, select the icon for the application you want to restore and then follow the on-screen instructions to complete the recovery process.

 Your system may include one or two Application Recovery CDs. If you have two Application Recovery CDs, insert the first CD to run the Application Recovery program. You may be prompted to insert the second CD, depending on the application you wish to restore.



# Troubleshooting

This section describes how to solve common problems you may encounter when using your notebook. Many problems have simple solutions, so try these suggestions before you contact Sony PC Support (<http://www.sony.com/pcsupport>).

## *Troubleshooting your notebook*

When starting your notebook for the first time, the VAIO InitManager dialog box will appear. Please select “OK” to begin initial setup. If you do not execute the initial setup, you cannot use part of VAIO original hardware functions such as Jog Dial, Power Management tool, scroll function of touchpad, and keyboard shortcut key function combined with the Fn key.

### *My notebook does not start.*

- Check that the notebook is plugged into a power source and that it is turned on. Check that the power indicator on the front panel of the notebook indicates that the power is on.
- Check that the battery packs are inserted properly and that they are charged.
- Make sure there is no diskette in the floppy disk drive.
- Confirm that the power cord and all cables are connected firmly, as described in “Connecting a Power Source” on page 25.
- If you plugged the notebook into a power strip or UPS, make sure the power strip or UPS is turned on and working.
- If you are using an external display, check that it is plugged into a power source and turned on. Check that the brightness and contrast controls are adjusted correctly. See the manual that came with your display for details.
- Moisture condensation may have occurred. Do not use the notebook for at least one hour and then turn on the notebook.
- Take the battery pack off the notebook, unplug the power cord and plug it again, then turn on the power.



***My notebook starts, but my system doesn't start properly.***

- When the internal backup battery is low on power, it may not start your system properly. The message “Press <F1> to resume, <F2> to setup” appears at the bottom of the screen. Follow these steps:
  - 1 Press F2. The BIOS Setup menu appears.
  - 2 Set the date (month/day/year). Press Enter.
  - 3 Press ↓ to select System Time, then set the time (hour: minute: second). Press Enter.
  - 4 Press → to select Exit, then press ↓ to select Get Default Values. The message “Load default configuration now?” appears.
  - 5 Select Yes and press Enter.
  - 6 Select Exit (Save Changes), and then press Enter. The message “Save Configuration changes and exit now?” appears.
  - 7 Select Yes, and then press Enter. The notebook restarts.

***My notebook starts, but the message “Operating system not found” appears and Windows does not start.***

- Make sure there is no diskette in the floppy disk drive (non-bootable).
- If a non-bootable diskette is in the drive, follow these steps:
  - 1 Turn off the notebook, and then remove the diskette.
  - 2 Restart the notebook and confirm that Windows starts properly.
- If Windows still does not start, follow the steps below to initialize the BIOS:
  - 1 Remove any diskette from the floppy disk drive.
  - 2 Remove any peripheral devices connected to the notebook.
  - 3 Turn off the notebook and then turn it on.
  - 4 Press the F2 key when the Sony logo appears. The BIOS setup menu screen appears.
  - 5 Press the directional arrow keys to select the Exit menu.
  - 6 Press the arrow keys to select “Get Default Values” and then press Enter. The message “Load default configuration now?” appears.

- 7 Select Yes, then press Enter.
- 8 Use the directional arrow keys to select “Exit” (Save Changes), and then press Enter. The message “Save configuration changes and exit now?” appears.
- 9 Select Yes, then press Enter. The notebook restarts.

If your notebook continues to display the message “Operating system not found”, and Windows does not start, contact Sony Customer Support.

### ***My notebook stops responding or does not shut down.***

It is best to shut down your notebook using the Shut Down command on the Windows Start menu. Using other methods, including those listed here, may result in loss of unsaved data.

- Try restarting the notebook. On the Windows taskbar, click the Start button, click Shut Down, and then click Restart.
- If you cannot restart as described in the preceding step, you can restart the notebook by pressing Ctrl+Alt+Delete.
- If the previous step does not work, press and hold the power button for at least four seconds. This turns off the power.
- If your notebook stops responding while playing a CD or DVD, stop the CD/DVD, and restart the notebook by pressing Ctrl+Alt+Delete.
- Unplug the notebook from the AC adapter and remove the battery pack from your notebook.

 Pressing Ctrl+Alt+Delete or turning off the notebook with the power switch may result in data loss in files that are currently open.

### ***My notebook does not enter the power saving mode I selected.***

- Click Start, point to Program, point to Accessories, point to System Tools, and then click System Information.  
The Help and Support window appears.
- Click System Configuration Utility under the Tools menu.

- ❑ Click the Advanced button on the General tab, and Confirm the following information:
  - 1 Enable Deep Sleep is selected with a checkmark.
  - 2 The message “Standby function is enabled” is displayed. If the message reads “Standby function is disabled”, click the Enable button.
  - 3 The message “Hibernation feature is enabled” is displayed. If the message reads “Hibernation feature is disabled”, click the Enable button.
  - 4 Click OK and restart your notebook.

***My system enters System Idle mode when System Suspend mode has been selected.***

- ❑ If you are connecting an optical disc drive with a PC card, disconnect it by stopping the PC card. Use the Sony Notebook Setup utility to disable devices that you are not currently using. See “To remove a PC card” on page 50 for more information.
- ❑ Make sure the PC Card is compatible with your notebook’s Windows® operating system.

***The Power Management setting is not responding.***

Your notebook’s operating system may become unstable if a lower power state, such as system hibernation is initiated and then changed before the notebook completely enters the lower power state. To restore the notebook to its normal operating stability:

- ❑ Close all open applications.
- ❑ Push and hold the power button for four seconds or longer to shut down the notebook.

***The sound of my notebook’s fan is too loud.***

Use the PowerPanel utility to change the Thermal Control Strategy setting to Quiet. This setting slows down the CPU speed. See PowerPanel Help for more information.

## ***Troubleshooting the LCD screen***

### ***My LCD screen is blank.***

- Check that the notebook is plugged into a power source and that it is turned on.
- Check that the power indicator on the notebook is on.
- Check that the battery pack(s) is inserted properly and that they are charged.
- The notebook may be in LCD (Video) Standby mode. Press any key to activate the screen.
- The display mode may be set to external display mode. Press and hold the Fn key while pressing F7 several times.

### ***My LCD screen continues to show the previous screen.***

Press the Windows key and D key twice to refresh the screen.

### ***The image on my connected external display is not centered or sized properly.***

Use the controls on your external display to adjust the image. See the manual that came with your display for more information.

### ***I want to change the video resolution of my display.***

You can use independent controls to change the video resolution of your display.

- Click Start, point to Settings, point to Control Panel, and then click the Display icon.  
The Display Properties dialog box appears.
- Click on the Settings tab.
- Move the Screen Area slider to change your video resolution.

## ***Troubleshooting the mouse and touchpad***

### ***My mouse does not work.***

- If you are using an external mouse, check that the mouse is plugged into the mouse connector. See “Connecting an External Mouse or Keyboard” on page 65 for details.

- ❑ If you connected an external mouse while your notebook is on, you must restart your notebook.
- ❑ If you are using an optional Sony USB mouse PCGA-UMS1, check that the mouse is plugged into the USB connector.

***My touchpad does not work properly.***

- ❑ You may have disabled the touchpad without a mouse being connected to the notebook. You must restart the notebook to make the touchpad work again.
- ❑ If your touchpad is interpreting a single tap as a double-click, you must adjust the button assignments. Follow these steps:
  - 1 Click Start, point to Control Panel, and then click on the Mouse icon.
  - 2 Change the button assignments in the Mouse Properties dialog box. (One of the buttons is assigned to the double-click action.)

***The pointer does not move (while using the Touchpad or Mouse).***

- ❑ Click the Start button on the Windows taskbar, and select Shut Down to display the Shut Down Windows dialog box, then press Enter.
- ❑ If you cannot turn off your notebook as described in the step above, press Ctrl+Alt+Delete to restart the notebook.
- ❑ If you cannot restart your notebook as described in the step above, press and hold the power button for more than four seconds to turn off the notebook.
- ❑ If the pointer does not move while playing a disc, press Ctrl+Alt+Delete to stop playback and restart the notebook.

***Troubleshooting drives, PC cards and peripheral devices***

***I inserted a compatible device into the multipurpose drive bay, but the icon does not appear in the My Computer window.***

- ❑ The device has not been recognized. Put the notebook into System Idle mode by pressing the Fn and S keys and then resume.
- ❑ If the device is still not recognized or does not appear in the My Computer window, remove and reinsert it.

***My floppy disk drive can not write to a diskette.***

- If the diskette is write-protected, disable the write-protect feature or use a diskette that is not write-protected.
- Check that the diskette is properly inserted into the floppy disk drive.

***My floppy disk drive icon doesn't appear even though it is connected.***

- Click Start, point to Settings, point to Control panel, and then click System. The System Properties dialog box appears.
- Click the Device Manager tab.
- Double-click Floppy Disk Controller and then click Standard Floppy Disk Controller.
- Click Delete. The Confirmation window will appear.
- Verify that Delete From All Settings is selected and press OK.
- Click Update in the System Properties window.
- Double click Disk Drive and confirm that GENERIC NEC FLOPPY DISK is shown.

***My CD, DVD, or CD-RW drive is not playing my CD or DVD properly.***

- Make sure the optical drive is inserted correctly into the multipurpose drive bay.
- Make sure the label of the disc is facing up.
- If the disc requires software, make sure the software is installed according to the manufacturer's instructions.
- A dirty or damaged disc may cause the notebook to stop responding while it tries to read the disc. If necessary, restart the notebook, remove the disc, and then check it for dirt or damage.
- If you see video but can not hear audio, check all of the following:
  - Check that your DVD-ROM drive does not have the mute setting enabled.
  - Check the volume setting in the audio mixer.
  - If you are using external speakers, check the volume settings, and then check the connections between your external speakers and the notebook.

- ❑ Click Start >Control Panel > System > Device Manager. Check that the correct drivers are installed properly.
- ❑ Do not use adhesive labels to identify the CD. The label may come off while the disc is in use in the optical drive and cause the drive to malfunction.
- ❑ If a region code warning appears when you try to use your DVD-ROM drive, it may be that the DVD you are trying to play is incompatible with the DVD-ROM drive. Check the region code listing on the DVD packaging.
- ❑ Moisture condensation may have occurred. Leave the notebook idle for at least 1 hour with the notebook turned on.

***My CD, DVD, or CD-RW drive tray does not open.***

- ❑ Make sure the notebook is turned on.
- ❑ Press the Eject button on the DVD-ROM drive.
- ❑ If the Eject button does not work, you can open the tray by inserting a sharp, pointed object into the hole to the right of the Eject button.

***I cannot use digital video (DV) devices. The message “DV equipment seems to be disconnected or turned off” appears.***

- ❑ Check that the DV device is turned on and that the cables are properly connected.
- ❑ If you are using multiple i.LINK devices, the combination of the connected devices may cause unstable operation. In this case, turn off your notebook and all connected devices. Disconnect the devices that are not in use. Check the connections for each device, then restart your notebook.

***The i.LINK-compatible devices connected to the Mini Docking Station do not work.***

- ❑ Use the i.LINK connector that is located on your notebook.
- ❑ If the message “There are no Digital Video devices connected to this computer, or the power is off” appears, unplug the i.LINK cable and try plugging it in again.

***My PC card is not working.***

- ❑ Make sure the PC card is compatible with Microsoft® Windows®.

- ❑ Use the Sony Notebook Setup utility to disable devices you are not currently using.
- ❑ If you are using two PC cards, use the Sony Notebook Setup utility to disable the devices you are not currently using.

## **Troubleshooting software**

### ***My software program stops responding or crashes.***

Contact the software publisher or designated provider for technical support. See the “For Answers to Your Software Questions” on page 94.

### ***When I click an application icon, the message “You must insert the application CD into your CD-ROM (DVD-ROM/CD-RW) drive” appears and the software does not start.***

- ❑ Some titles require specific files that are located on the application CD. Insert the disc and try starting the program again.
- ❑ Make sure you place the CD in the tray with the label side facing up.

### ***I hear background “noise” while using Windows Media Player to play my music CDs.***

Sony suggests using the preinstalled Media Bar software to play audio CDs.

### ***I can not use the DVgate software.***

If your notebook is using the Ultimate Battery Life profile for its power saving mode, you cannot use DVgate or Smart Connect software. Please select another profile.

### ***My voice-related software does not work properly.***

Disable echo function of the microphone by taking the following steps:

- 1 Click Start, point to Settings, and then point to Control Panel.
  - 2 Click Yamaha DS-XG.
  - 3 Click the Echo tab and remove the checkmark. Click OK.
- ❑ Contact the software publisher or designated provider for technical support



## Troubleshooting the modem

### *My modem does not work.*

- Check that the phone line is plugged into the line jack. See “Connecting a Phone Line” on page 62 for details.
- Check that the phone line is working. You can check the line by plugging in an ordinary phone and listening for a dial tone.
- Check that the phone number the program is dialing is correct.
- Check that the software you are using is compatible with the notebook’s modem. (All preinstalled Sony programs are compatible.)

### *My modem connection is slow.*

Your notebook is equipped with a 56K/V.90 compatible modem. Many factors may influence modem connection speed, including telephone line noise or compatibility with telephone equipment (such as fax machines or other modems). If you think your modem is not connecting properly to other PC-based modems, fax machines, or your Internet Service Provider, check the following:

- Have your phone company check that your phone line is free from any line noise.
- If your problem is fax-related, check that there are no problems with the fax machine you are calling and that it is compatible with fax modems.
- If you are having a problem connecting with your Internet Service Provider, check that the ISP is not experiencing technical problems.
- If you have a second phone line available, try connecting the modem to that line.

## Troubleshooting audio

### *My speakers have no sound.*

- If the built-in speakers are turned off, press Fn+F3 to turn on the speakers. You can also turn on the speakers using the Jog Dial control.
- If the speaker volume is turned to the minimum, press Fn+F4, and then press **↑** or **→** to increase the volume or you can use the Jog Dial control to control the volume.
- If nothing is displayed when you press Fn+F3 or Fn+F4.

- 1 Double click System in Control Panel.
  - 2 Set the sound device to enable in Device Manager.
- If your notebook is powered by batteries, check that the battery packs are inserted properly and that they are charged.
  - If you are using an application that has its own volume control, check that the volume is turned up.
  - Check the volume controls in Windows.®
  - If you connect external speakers, check that the speakers are properly connected and the volume is turned up. If the speakers have a mute button, make sure it is off. If the speakers are powered by batteries, check that the batteries are inserted properly and that they are charged.
  - If you have connected an audio cable to the Headphone connector, disconnect the cable.

### *My microphone does not work.*

If you are using an external microphone, check that the microphone is plugged into the Microphone connector. See “Connecting an External Microphone” on page 75 for details.

## *Troubleshooting the printer*

### *I cannot print.*

- The default setting for the printer port mode is correct for most printers. If you cannot print, try changing the printer port mode. In Sony Notebook Setup, select the Printer tab. If the printer port mode is set to ECP, change it to bi-directional. If the printer port mode is set to bi-directional, change it to ECP. See “Displaying the Sony Notebook Setup Screen” in the “*Customizing Your VAIO® Notebook*” manual for details on using Sony Notebook Setup.
- Your connected printer may not function after the computer resumes from a power saving mode. If this occurs, follow these steps to reset the printer connection:
  - Right-click the My Computer icon on the desktop, and then select Properties.
  - Click the Device Manager tab.
  - Select Refresh, and then click OK. The printer should function properly.



# Specifications

<b>Model</b>	<b>PCG-F640</b>
<b>Processor</b>	650 MHz* Intel® Pentium® III with Intel® SpeedStep™ Technology <sup>†</sup>
<b>Hard Disk Drive</b>	12 GB <sup>‡</sup>
<b>C / D Partition (Approximate)</b>	40% and 60%
<b>Standard RAM</b>	128 MB SDRAM, expandable to 256 MB
<b>LCD Screen</b>	13.3" XGA TFT
<b>L2 Cache Memory</b>	256KB (CPU Intergrated)
<b>MPEG</b>	MPEG1 and MPEG2 Digital Video; supports full-screen playback
<b>Graphics</b>	3-D graphic accelerator with 8 MB Video RAM ATI 3D RAGE™ Mobility-M1
<b>Sound Capabilities</b>	16-bit CD-quality stereo sound
<b>Diskette Drive</b>	Removable 3.5" 1.44 MB
<b>DVD-ROM Drive</b>	Reads CD data from 10.3X to 24X variable transfer rate.** Reads DVD data from 1.7X to 8X variable transfer rate. <sup>††</sup>
<b>Laser Diode Properties</b>	DVD-ROM: Wavelength 770 nm and 660 nm laser output 30.2 μW
<b>Modem</b>	V.90/K56flex compatible modem <sup>††</sup>
<b>Infrared</b>	Supports 4 Mbps, 1.1 Mbps, and 115 Kbps IrDA Standard
<b>Drive Bay</b>	Supports floppy disk drive (included) Supports second rechargeable battery (optional)
<b>Expansion Capabilities</b>	Type II PC cards and Type III PC card Card Bus support
<b>Built-in Capabilities</b>	Stereo speakers, Touch pad
<b>Telecommunication Capabilities</b>	Data and fax send/receive <sup>††</sup>

<b>Model</b>	<b>PCG-F640</b>
<b>Connection Capabilities</b>	2 USB ports i.LINK <sup>†††</sup> Serial port Keyboard/mouse (USB and PS/2® style) VGA monitor Parallel (printer) Phone line (RJ-11) TV out Microphone Headphone Port replicator Infrared port
<b>Supplied Accessories</b>	Video cable Floppy disk drive Rechargeable battery AC adapter and power cord Weight saver
<b>Power Requirements</b>	58.5 watts maximum (19.5V DC/AC 100-240V)
<b>Power Management</b>	Energy Star compliant Advanced Configuration and Power Interface (ACPI)
<b>Battery</b>	Lithium-ion, supports dual battery operation
<b>Dimensions</b>	12.8"(w) x 1.9"(h) <sup>***</sup> x 10.3"(d), (324 x 46.9 x 265.5mm)
<b>Weight</b>	6.7 lbs. (3.1 kg) (with battery and weight saver) 7.1 lbs. (3.2 kg) (with battery and floppy disk drive)
<b>Operating Temperature</b>	41° F to 95° F (+5° C to 35° C) temperature gradient less than 18° F (10° C) per hour
<b>Operating Humidity</b>	20% to 80% (not condensed), provided that humidity is less than 65% at 95° F (35° C), hygrometer reading of less than 84° F (29° C)
<b>Storage Temperature</b>	-4° F to 140° F (-20° C to 60° C), temperature gradient less than 18° F (10° C) per hour

<i>Model</i>	<i>PCG-F640</i>
<i>Storage Humidity</i>	10% to 90% (not condensed) provided that humidity is less than 20% at 140° F (60° C), hygrometer reading of less than 95° F (35° C)

\* MHz denotes microprocessor internal clock speed; other factors may affect application performance.

† The processor may be reduced to a lower operating speed when operating on battery power.

‡ The size of your hard disk may differ if you purchased a specially configured system. GB means one billion bytes when referring to hard drive capacity. Accessible capacity may vary.

\*\* Data on a CD-ROM is read at a variable transfer rate, ranging from 10.3X at the innermost track to 24X at the outermost track (the data transfer standard 1X rate is 150 kbytes/s). The average data transfer rate is 17.2X or 2580 kbytes/s.

†† Data on a DVD is read at a variable transfer rate, ranging from 1.7X at the innermost track to 4X at the outermost track (the data transfer standard 1X rate is 1392 kbytes/s). The average data transfer standard is approximately 2.85X or 3823 kbytes/s. A DVD-ROM drive reads data on a CD at a variable transfer rate, ranging from 10.3X at the innermost track to 24X at the outermost track. The average data transfer rate is approximately 17.15X or 2936 kbytes/s or 2576 kbytes/s.

If a region code warning appears when you are using the DVD player, it could be that the DVD you are trying to play is incompatible with the DVD-ROM drive in your VAIO notebook. Region code indicators such as a “1” or “ALL” are labeled on some DVDs to indicate what type of player can play the discs. Unless a “1” or “ALL” is identified on your DVDs or on the packaging, you cannot play the disc on this player.

‡‡ Maximum speed for faxing is 14.4 kbps. Your 56K/V.90 compatible modem is capable of downloading at 53 kbps. Your online service or Internet Service Provider, however, may not support this technology or operate at this speed.

\*\*\* Height measured at thickest point. The thinnest height is 1.4" (35.8 mm).

††† i.LINK is a trademark of Sony used only to designate that a product contains an IEEE 1394 connector. All products with an i.LINK connector may not communicate with each other.

Specifications are subject to change without notice.



# Index

## A

About Your Recovery CDs 94

AC adapter 21, 25

AC power 25

adding

    hardware 59

    memory 81

    peripherals 59

    printers 63

adjusting

    brightness 32, 36

Alt key 34

Application Recovery CD 99

Applications key 34

attaching port replicator 70

## B

battery packs 21, 26

    charging 27, 54

    indicator lights 28, 35, 52

    inserting 26

    inserting into battery bay 26

    loading 26

    rechargeable 25

    removing 29, 52, 54

brightness

    adjusting 32, 36

built-in speakers

    See also speakers 36

buttons

    Eject 43, 45

    Start (Windows Me) 32

## C

cables

    phone 21

    power cord 25

cameras

    digital video recorder 60

canceling commands 34

Caps Lock

    indicator light 36

CD-ROM/DVD-ROM discs

    ejecting 45

    inserting 43

CD-ROMs

    handling 47

charge status indicator light 28

charging battery packs 27, 54

choosing

    power source 26

coin-operated telephones 62

computer

    handling 19



- lithium ion battery 7
  - setting up 21
  - starting 31
  - troubleshooting 101, 109
  - unpacking 14
- connecting
  - coin-operated telephones 62
  - digital video recorder 60
  - external speakers 74
  - hard drives 48
  - microphone 75
  - monitor 66
  - multimedia computer display 67
  - multiple phone lines 62
  - network 48, 70
  - party phone lines 62
  - PBX 62
  - phone line 62
  - port replicator 70
  - power source 25
  - printer 63
  - projector 67
  - USB device 76
  - weight saver 56
- connectors
  - DC In 25
  - infrared 51
  - network 70
  - Printer 63
  - printer 63
  - Serial port 70
- correction keys 34
- Ctrl key 34
- cursor-movement keys 34
- D
- DC In 25
- digital still camera 51
- digital video camera 60
- disconnecting port replicator 73
- diskettes
  - troubleshooting 107
- display
  - options 68
  - selecting 68
- disposal of lithium ion battery 7
- drives
  - floppy disk 21
  - installing additional hard disk 48
- DV In/Out 60
- DVD-ROM drive
  - closing tray 45
  - opening tray 43
  - using 43
- DVD-ROM drive tray
  - troubleshooting 108
- DVD-ROMs
  - handling 47
- E
- Eject button 43, 45
- ejecting
  - battery packs 54
- CD-ROM/DVD-ROM discs

- 45
- weight saver 57
- Energy Star 2
- ergonomic considerations 17
- Escape key 34
- expansion memory
  - configuration 82
- external devices
  - display 68
    - See also monitor
  - speakers 36, 74
- F
- faxes
  - laws governing 6
- floppy disk drive 21
  - cable 21
  - disconnecting 41
  - troubleshooting 107
- Fn key 34
  - combination commands 36
- function keys 34
- H
- handling 19
  - CD-ROMs and DVD-ROMs 47
- handling the LCD screen 19
- hard drives
  - indicator light 35
  - installing additional 48
- headphone connector 67
- Help
- Mouseware 39
- I
- i.LINK 60
- IEEE-1394 60
- indicator lights 35
  - battery 28, 35, 52
  - Caps Lock 36
  - charge status 28
  - hard drive 35
  - Num Lock 36
  - Scroll Lock 36
- infrared communication devices 51
  - other computers 51
- infrared port 51
- infrared transmission
  - active distance 52
  - troubleshooting 52
- input devices 5
- Insert key 34
- inserting
  - battery pack 26
  - CD-ROM/DVD-ROM discs 43
- installation 18
- installing
  - hard drives 48
  - hardware 59
  - memory module 83
  - peripherals 59
- interference 5

## K

keyboard 34

## L

### LCD

- lock lever 31
- selecting to display output  
68
- troubleshooting 105

### LCD screen

- handling 19

### lever

- LCD 31
- weight saver release 55

### lithium ion battery

- disposal 7
- safety precautions 7

### loading

- battery pack 26

## M

maintenance 19

### memory module

- expansion 82
- installing 83
- removing 82

### microphone

- connecting 75
- connector 67
- troubleshooting 111

### modem

- laws governing 6
- troubleshooting 110

## monitor

- connecting 66
- connector 67
- selecting 68
- switching among 37

## mouse

- troubleshooting 105

Mouse Properties screen 39

## Mouseware

- accessing help 39
- features 39

MovieShaker instructions 89

multimedia computer display  
67

multiple phone lines 62

## N

navigation keys 34

## network

- connecting 48
- connector 70
- port replicator 70

Notebook Computer 21

## Num Lock

- indicator light 36

## O

### opening

- DVD-ROM drive tray 43

operator keys 34

### output devices 5

- adding 63

- P
- party phone lines 62
  - PBX 62
  - PC card
    - inserting 48
    - release button 48
    - slot protector 48
    - slots 48
    - troubleshooting 108
  - phone
    - cable 21
    - connecting line 62
    - jack 62
    - laws governing 6
  - port replicator
    - connecting 70
    - disconnecting 73
    - lever 73
    - network 70
  - power 35
    - cord 25
    - switch 31
  - power saving modes 77
    - System Hibernation 37, 78
    - System Idle 77
    - System Suspend 78
    - Video Standby 37
  - power source 25
  - power sources 26
    - connecting 25
  - Print Screen key 34
  - printer
    - connecting 63
    - connector 63
    - port 63
  - Printer connector 63
  - projector 67
- R
- radio interference 5
  - rechargeable battery packs 25, 26
  - recharging battery packs 27
  - Recovery CD 99
  - regulatory information 5
  - removing
    - battery packs 29
    - floppy disk drive 41
    - memory module 82
  - replacing
    - battery packs 52
  - restoring data 99
- S
- Scroll Lock
    - indicator light 36
  - second battery pack 26, 52
  - selecting
    - display 68
    - LCD 68
    - monitor 68
    - power source 26
  - Serial connector 70
  - Shift key 34
  - Software list 85
  - Sony Service Center 96

speakers

- external 74
- switching 36
- troubleshooting 110
- volume 36

Specifications 113

starting

- computer 31

startup problems 32

switching

- display 37
- monitor 37

System Hibernation mode 37, 78

System Idle mode 37, 77

System Suspend mode 36, 78

T

touchpad 38

troubleshooting 101

- startup 32, 101

turning on

- computer 31

TV

- interference 5

U

unpacking the computer 14

USB

- connecting 76
- connector 76
- mouse 76

V

ventilation slot 24

video camera 60

Video Standby mode 37

viewing the amount of memory 84

volume control 36

W

weight saver

- attaching 53
- connecting 56
- fold-out arm 56
- removing 57

Windows Me

- Explorer 34
- Find window 34
- help 34
- key 34
- key combinations 34
- Start button 32
- taskbar 32